



WOOD FLOORING

INSTALLATION GUIDELINES



WOOD FLOORING INSTALLATION GUIDELINES

1	INTRODUCTION	87	SUBSTRATES: Radiant Heat
2	HEALTH AND SAFETY Personal Protective Equipment Fire and Extinguisher Safety Electrical Safety Tool Safety Industry Regulations	102	SUBSTRATES: Existing Flooring
11	INSTALLATION TOOLS Hand Tools Power Tools Pneumatic Tools Blades and Bits	106	UNDERLAYMENTS: Moisture Control
19	WOOD FLOORING PRODUCT Wood Flooring Options Trim and Mouldings Packaging Conversions and Calculations	110	UNDERLAYMENTS: Sound Control/Acoustical
26	INVOLVED PARTIES	116	LAYOUT Working Lines Trammel Points Transferring Lines 45° Angles Wall-Layout Center-Layout Lasers
28	JOBSITE CONDITIONS Exterior Climate Considerations Exterior Conditions of the Building Building Thermal Envelope Interior Conditions	121	INSTALLATION METHODS: Nail-Down
33	ACCLIMATION/CONDITIONING Solid Wood Flooring Engineered Wood Flooring Parquet and End-Grain Wood Flooring Reclaimed Wood Flooring	132	INSTALLATION METHODS: Glue-Down
38	MOISTURE TESTING Temperature/Relative Humidity Moisture Testing Wood Moisture Testing Wood Subfloors Moisture Testing Concrete Subfloors	140	INSTALLATION METHODS: Floating
45	BASEMENTS/CRAWLSPACES	145	INSTALLATION METHODS: Parquet
48	SUBSTRATES: Wood Subfloors	150	PROTECTION, CARE AND MAINTENANCE Educating the Customer Protection Care Maintenance What Not to Use
61	SUBSTRATES: Concrete Subfloors	153	REPAIRS, REPLACEMENT AND REMOVAL Repair Replacement Floating Floor Board Replacement Lace-Out/Lace-In Addressing Water Damage
76	SUBSTRATES: Wood Subfloor Systems Over Concrete	161	GLOSSARY
81	SUBSTRATES: Screeds/Sleepers	176	SOURCES AND CREDITS

NOTICE

The National Wood Flooring Association assumes no responsibility and accepts no liability for the principles or techniques contained in these guidelines/methods. These guidelines and methods for the installation of wood flooring were developed by the NWFA Technical Publications Committee, together with leading industry authorities, through review of longstanding installation principles, along with research and data regarding wood flooring installation. These guidelines and methods address a variety of ancillary products and components related to the installation of wood flooring, but are not intended to address issues arising to or from those components directly.

While every effort has been made to produce accurate and generally accepted guidelines, the principles and practices described in this publication are not universal requirements and may change. The recommendations in these guidelines/methods are directed at the North American market in general, and therefore may not necessarily reflect the most-accepted industry practices in other geographic areas. Some installation methods and materials may not be suitable in some geographic areas because of local trade practices, climatic conditions, or construction methods. All wood flooring installations must conform to local building codes, ordinances, HOA CC&Rs (Covenants, Conditions and Restrictions), trade practices, and climatic conditions.

In addition, manufacturers' recommendations for installation of specific products should always supersede the recommendations contained in these guidelines.

It is recommended that all wood flooring products be installed in accordance with the NWFA Installation Guidelines and all applicable manufacturer instructions by an NWFACP Certified Installer, NWFA member, or equivalent.

© Copyright 2025. National Wood Flooring Association. St. Louis, Missouri, U.S.A. All rights reserved under both international and Pan American copyright conventions.

INTRODUCTION

One of the many benefits of wood flooring is that, when installed and maintained properly, they are the only flooring option that can last for hundreds of years. In fact, there are documented wood floors in Europe that date back more than five centuries. Wood flooring can be maintained and restored to its original appeal after decades of wear and use.

Even the finest carpets will wear out after only a few years of traffic. Tile and stone can crack or chip when something gets dropped on them, and grout can crack and stain over time. Plastic and vinyl flooring can suffocate the home, and are generally designed to be disposable.

Those who work with wood floors for a living know that installing them is not a DIY job. You have to have the right tools, the right subfloor, the right jobsite conditions, and the right skills to have a successful installation. Wood flooring professionals who receive the proper training, and have the necessary industry knowledge, will be well-prepared for nearly any job they encounter.

Wood flooring is available in a wide range of options, including species, widths, thicknesses, shapes and sizes, and even different levels of hardness and dimensional stabilities. Each of these options necessitate an understanding and careful consideration for proper installation of the products. There are a number of processes that must be correctly undertaken in order to achieve a floor with the performance and appearance that is of professional standards.

These Guidelines outline the industry-accepted methods and procedures for wood flooring installations. The information included has been organized in a way that will contribute to a successful installation.



HEALTH AND SAFETY

Before starting any installation job, certain basic standards of safety must be applied. It is important that all crew members are briefed and updated on all requirements and regulations. This is important for the safety of you, the crew, the customer, and the jobsite.

Before considering going out to install a wood floor, it is imperative to be aware of the safety issues involved. Besides being a vital health issue, following safety regulations is also required by law. Failure to comply can cost you thousands of dollars in fines.



The Occupational Safety and Health Administration (OSHA) administers rules that aim to protect the safety of workers on the jobsite. These rules may vary according to whether the job is residential or commercial, and requirements are also different for homeowners and professionals. Check OSHA requirements in your area at www.osha.gov.

PART I Personal Protective Equipment

Personal protective equipment (PPE) is essential to keeping you safe on the wood flooring jobsite. There are six main types of personal protective equipment designed for wood flooring professionals:



Eye Protection

Thousands of people are blinded each year from work-related eye injuries that could have been prevented with the proper selection and use of eye protection.

Eye injuries alone cost more than \$300 million per year in lost production time, medical expenses, and worker compensation.

OSHA requires employers to ensure the safety of all employees in the work environment. Eye protection must be provided whenever necessary to protect against chemical, environmental, radiological, or mechanical irritants and hazards. Good eye protection is meant to:

- Provide adequate protection against the particular hazards for which they are designed.
- Be of safe design and construction for the work to be performed.
- Be reasonably comfortable when worn under the designated conditions.
- Fit snugly and not unduly interfere with the movements of the wearer.
- Be durable.
- Be capable of being disinfected and easily cleanable.
- Be distinctly marked to facilitate identification of the manufacturer.

In addition:

- Workers who wear prescription eye glasses must also wear required eye protection.
- Eye protection often fits comfortably over glasses.
- Safety goggles and safety glasses may incorporate prescription lenses as well.
- Dust and chemicals present additional hazards to contact wearers. OSHA recommends that workers have an extra pair of contacts or eyeglasses in case of failure or loss.

Ear Protection

Use of ear protection is very important due to the high decibel of many of the tools used in the wood flooring industry. Each hearing protection device has a noise reduction rating (NRR). The higher the number, the greater the decibel reduction. Which type of hearing protection you choose depends on a number of factors including level of noise, comfort, and suitability of the hearing protector. Most importantly, the hearing protector should provide the desired noise reduction. According to OSHA, people should wear a hearing protector if the noise or sound level at the workplace exceeds 85 decibels (A-weighted) or dBA.

Ear protection for wood flooring professionals generally comes in two types:

- A. **Ear Muffs:** Ear muffs consist of sound-attenuating material and soft ear cushions that fit around the ear and hard outer cups. They are held together by a head band.



- B. **Ear Plugs:** Ear plugs are inserted into the ear canal to block sound. They may be pre-molded (preformed) or moldable (foam). Insert ear plugs as follows:

- Roll the ear plug into a small crease-free cylinder.
- Reach over the head to pull up and back on the ear to straighten the ear canal.
- Insert the ear plug snugly.



Respiratory Protection

The respirators utilized in the wood flooring industry are used for the removal of contaminants from the air. Respirators of this type include disposable particulate respirators, which filter airborne particles, and air-purifying respirators with cartridges/canisters, which filter out chemicals and gases. It is important to note that a full beard will not allow masks to fully protect against particles, vapors, or gases entering the lungs. There are three main types of respirators used in the wood flooring industry:

- A. **Disposable Particulate Respirators:** Wood dust becomes a potential health problem when wood particles from processes such as sanding and cutting become airborne. Breathing these particles may cause allergic respiratory symptoms, mucosal and non-allergic respiratory symptoms, and cancer. Proper use of a disposable particulate respirator minimizes the effects of these airborne particulates, but does not protect against gases or vapors.

- B. **Half-Facepiece Elastomeric Respirators:** Half-facepiece elastomeric respirators are attached to a rubber or silicone facepiece that covers the nose and mouth. This type of respirator needs to be fit tested.

It can be cleaned, decontaminated, and reused. The useful service life of the filter or cartridges is how long it provides adequate protection

from harmful chemicals in the air. The service life of a filter or cartridge depends upon many factors, including environmental conditions, breathing rate, cartridge filtering capacity, and



the amount of contaminants in the air. Check with the manufacturer of the filter or cartridge for proper storage and service life recommendations.

- C. **Full-Facepiece Elastomeric Respirators:** Like the half-mask elastomeric respirator, this respirator is a tight-fitting, air-purifying respirator

with replaceable filters or cartridges attached to a rubber or silicone facepiece. It needs to be fit tested. The useful service life of the filter or cartridges is how long it provides adequate protection from harmful chemicals in the air. The service life of a filter or cartridge depends upon many factors including environmental conditions, breathing rate, cartridge filtering capacity, and the amount of contaminants in the air. Check with the manufacturer of the filter or cartridge for proper storage and service life recommendations.



Knee Protection

It is extremely important to protect your knees when doing any type of wood flooring work. When installing or finishing wood floors, you spend a lot of time on your knees. This position forces your body weight to the joints of your knees as well as the added weight of the equipment. Knee pads are the solution to preventing occupational knee injuries. Unprotected, sore knees force overcompensation in order to use your knees less. This means that you are transferring the weight that would have been on your knees to your lower back. The result is a sore back and sore knees. Be sure to use knee pads that are comfortable and protect your knees from injury. Avoid knee pads with a hard surface that may mar the flooring surface. There are many different types of knee pads available. The function of all knee pads is the same: to prevent knee injury and to protect your knees on the job.



Gloves

Disposable gloves are used to protect the skin from chemical exposure. They are made of different polymers including latex, nitrile rubber, vinyl, and neoprene. Protective gloves should be used when handling adhesives, sealers or solvents of any type. Check with your manufacturer for



specific recommendations for protection from specific chemicals. Gloves should always be removed before using saws or other large tools that can potentially catch in machines.

Jobsite/Construction Zone Protection

Any worker entering construction areas is required to wear construction zone protection. This is applicable to commercial and residential jobsites, as well as new and existing construction.

- A. **Footwear:** Construction workers should always wear work shoes or boots with slip-resistant and puncture-resistant soles. It's also a good idea to wear safety-toed boots to prevent crushed toes. These are often made with steel-toed features. Good foot protection is also key outside of construction zone jobsites. When installing wood floors, proper work shoes can protect from boards and other equipment damaging the foot. Boots and shoes should also be non-marking to prevent scuffing and scratching finished floors.



- B. **Hardhats:** Hard hats are an essential piece of personal protective equipment in a construction zone. When worn properly, they can protect against bumps to the head from fixed or falling objects and can protect your head from making accidental contact with electrical hazards. It is important to inspect hard hats regularly. Hard hats should be routinely inspected for dents, cracks or other signs of deterioration. Always replace hard hats after sustaining a heavy blow or electrical shock.

PART II Fire and Extinguisher Safety

Understanding how fire works will help promote fire safety. Fire safety is based upon keeping fuel sources and ignition sources away from each other. Three things must be present at the same time in order to produce fire:

- Enough oxygen to sustain combustion.
- Enough heat to reach ignition temperature.
- Some fuel or combustible material.

Together, these three things produce a fire. Take away any of these items and the fire will be extinguished.

Fires are classified according to the type of fuel that is burning. If you use the wrong type of extinguisher on the wrong class of fire, you might make matters worse. It is important to understand the five different fire (or fuel) classifications.

FIRE SAFETY SET



Different types of fire extinguishers are designed to fight different classes of fires.

The three most common types of fire extinguishers are:

- A. **Water:** These extinguishers are also called Air Pressurized Water or APW extinguishers. They are designed for Class A fires only.
- B. **Carbon Dioxide or CO₂:** These extinguishers are designed for Class B & Class C fires only.
- C. **Dry Chemical:** These extinguishers are also called ABC, BC, and DC extinguishers. They are designed for Class A, B, or C fires. Dry chemical is the type of extinguisher required for the hardwood flooring industry.

ABC fire extinguishers, also referred to as dry chemical extinguishers, are clearly labeled on each extinguisher. They are designed to put out fires by coating the fuel with a thin layer of dust, thus separating the fuel from the oxygen in the air. The powder works to interrupt the chemical reaction of the fire.



While installing hardwood floors, it is important you keep fire extinguishers on hand. The extinguisher must be ABC-rated in order to handle the potential fires that could happen on the jobsite.

Class A Fires

There are many different ways Class A fires can be caused and prevented on the jobsite.

- A. Spark and friction fires can be caused by the sparks created with the friction created from grinding nails or other metal objects. Spark fires can also be caused by improperly aligned equipment. Always be cautious of creating sparks near flammable materials.
- B. Spontaneous combustion can occur due to wood dust igniting in the dust-collection bag, vacuum, or container. Wood dust must reach a temperature of 400 F° or 204 C° for it to ignite. Always remove dust receptacles and dust

collection systems from the jobsite at the end of every day and dispose of them in a proper manner. The most-common type of spontaneous combustion in our industry is caused by stain rags that are not disposed of properly. Oil-based stains, natural oils, varnishes, shellacs, polyurethanes, and paint thinners are common products that can be culprits. Spontaneous combustion occurs when the solvent or substance begins to oxidize. This process causes an exothermic reaction, meaning it releases heat. If the heat has no way to escape, like in a pile of rags, the temperature will continue to rise to a level high enough to ignite the rags. A cotton rag containing any amount of stain residue has the perfect surface-area-to-mass ratio to spontaneously combust. Therefore, you should dispose of rags in an air-tight metal container.

Class B Fires

Class B fires are caused by flammable liquids and their vapors. On a wood flooring jobsite, these can include things like lacquer thinner, mineral spirits, solvent-based sealers, and some solvent-based adhesives. You can minimize the risk of Class B fires by turning off pilot lights and all ignition sources before using flammable liquids on the jobsite.

Class C Fires

Class C electrical fires are caused by faulty cords, loose connections, breaker box fires, bad switches, faulty equipment, or improper cord selection.

Fire Extinguisher

- A. Always have two extinguishers on hand: one in the truck and one on the jobsite.
- B. Know how to operate.
- C. Hold flat and level.
- D. Check for and maintain expiration dates.
- E. No smoking.
- F. Responding to a Fire:
 1. Sound the fire alarm.
 2. Call the fire department.
 3. Assist any persons in immediate danger to safety.
 4. Before deciding to fight a fire, check the following:
 - a. Is the fire spreading rapidly beyond the point where it started?
 - b. If the fire is already spreading quickly, it is best to evacuate the building.
 5. Do not fight the fire if:
 - a. You don't have adequate or appropriate equipment.
 - b. You might inhale toxic smoke.
 - c. Your instincts tell you not to.

6. Select the appropriate type of fire extinguisher.
7. Identify a safe evacuation route, and don't let the fire block your escape.
8. P.A.S.S. Method:



9. Back Away.
10. Evacuate.

PART III Electrical Safety

Electrical hazards can be found on nearly every jobsite. Whether the hazard is posed by damaged or worn power tools or cords, improperly grounded tools, or the power sources themselves, it is critical to understand the potential electrical dangers on the jobsite. Most wood flooring professionals are not licensed electricians. However, you should have a clear understanding of electricity and the requirements your equipment needs to operate properly. You must be thoroughly cognizant of electrical safety to maintain a safe work environment.

Equipment Requirements

Probably the most overlooked electrical safety precaution is knowing what the power requirements are for each piece of equipment on the jobsite. It is essential to read the operations manual for all equipment and understand what the electrical requirements are for each power tool.

Circuit Breaker Panels

The circuit breaker panel should be the first electrical item assessed on the jobsite. Read the owner's manual on the tools being used on the jobsite to determine power requirements. You should be able to determine whether proper power is available for the equipment you will be using on the job. If after evaluating the circuit breaker panel you are still unsure of power capabilities, a licensed electrician will need to set up electrical connections.



The following are some of the basics:

- A. **Neutral and hot wires:** Current flows from the panel toward the load along the hot wires and returns along the neutral. Each hot wire's copper tip ultimately connects to its control switch at the circuit breaker, and each neutral connects to a common terminal.
- B. **Main breaker:** This is the on/off switch to the entire breaker panel. A 200-amp breaker is common for a home of 2,000 square feet. Smaller buildings may use 150-amp or 100-amp; small homes and subpanels can use as little as 50-amp.
- C. **Double-pole breaker:** Uses the entire 240 volts available to the panel. The 15-amp breakers often handle baseboard heaters, 30-amp serve water heaters and electric dryers, 40- and 50-amp are for electric ranges, and the 70-amp could serve a large air conditioner or a subpanel.
- D. **Single-pole breaker:** The 15-amp and 20-amp are all-purpose breakers, running everything from lights and outlets to the garage-door openers.
- E. **15-amp AFI breaker:** Arc-fault-circuit-interrupter breakers can prevent fires caused by accidental electrical discharge.
- F. **Ground wires:** Grounding prevents a conductor not meant to carry current (such as the metal side of a clothes dryer) from causing injury if it's energized by a frayed hot wire. In a properly grounded system, appliances and metal boxes connect back to the grounding bus of the breaker panel. From there, the system is grounded to the earth via buried ground rods.



Voltage

A multimeter, also known as a VOM (Volt-Ohm-Milliammeter), typically measures voltage, current, and resistance. Always keep a multimeter on hand to test for proper voltage at power sources and through cords. Ensure power at the jobsite is sufficient for the equipment being used. If insufficient power is detected, the use of a power booster can help deliver adequate power to the tools being used.

Outlets

You should know the basics of the different types of power available at any jobsite. In the United States, 15- or 20-amp breakers are common. These are all-purpose power sources that run lighting and outlets. 30-, 40-, and 50-amp breakers are common power sources for electric dryers, electric ranges, or other large appliances. The type of plug in the wall will be dictated by its use. Have adapters made before arriving at the jobsite to be able to connect to each type of outlet. Also, ensure you take into account the type of power you are attempting to plug into in relation to the equipment you will be using. Note that power sources and requirements will differ in other countries.

Cords

The quality of cords can be easily overlooked, but can cause serious repercussions if not addressed.



- A. Check cords regularly for damage or deterioration. If they are cut, cracked, or have broken insulation, do not use them. Check and tighten connections on the plugs and connectors regularly.
- B. There are safety regulations you must follow on the jobsite related to extension cords. Occupational Safety and Health Administration (OSHA) requires three-wire extension cords at all jobsites. These 3-wire extension cords are designed for hard or extra-hard usage.
- C. Ground-fault circuit interrupters, referred to as GFCIs, must be used on all projects for 120-volt,

single phase 15-, and 20-amp services. When using a generator or temporary pole, a GFCI is required, or a portable unit must be used.

- D. When the grounding pin on a plug of a power tool is missing, repair or replace it before using the cord. Using a tool with a missing grounding pin can be extremely dangerous for the user. If a short were to develop in the tool, the user can become the ground in the system, and the electricity may travel through him or her.
- E. Wire gauge is a measurement of how large a wire is, either in diameter or a cross-sectional area. This determines the amount of electric current a wire or extension cord can carry safely as well as the electrical resistance and weight per unit per length.
- F. American Wire Gauge (AWG) is a US standard set for non-ferrous (copper or aluminum) wire conductor sizes. The “gauge” means the diameter.
- G. Extension Cord Amp Ratings:

LENGTH IN FEET	16 AWG	14 AWG	12 AWG	10 AWG
25	13A	15A	15A	30A
50	13A	15A	15A	20A
100	10A	15A	15A	20A

- H. Select the proper gauge cords for the machinery you will be using. Longer distances will require heavier gauge cords and/or use of a booster. When improper gauge cords are used, plugs, wires, and equipment motors can overheat, causing permanent damage. The size of the wire in an extension cord set must be sufficient to handle the amperage that will be drawn by the tools connected.

Cord Placement

Never place any cord around your neck or over your shoulders. It is unsafe, and if the cord had a nick or cut in the insulation, it



could get wet from sweat and short out. It also can cause body fatigue and muscle fatigue. Our body is a DC current, and the power source is an AC current, meaning it will interrupt the flow of current in our body. This causes muscle fatigue.

Disconnect

It is important to disconnect all power when leaving the jobsite. The cord itself should never be pulled to disconnect it from the power source; instead, remove it by the plug.

**PART IV
Tool Safety**

- Start with a safe work area. Keep the work area clean and well lit. Cluttered workspaces and improperly lit jobsites invite accidents.
- Do not operate any power tools in explosive atmospheres, near flammable liquids, gases or dust. Power tools can create sparks, which may ignite the dust of fumes.
- Keep bystanders, children, homeowners, and visitors away when using power tools.
- Grounded tools must be plugged into a properly grounded installed outlet. Never remove or cut off the grounding prong or modify the plug in any way.
- Store battery packs away from other metal objects like paper clips, coins, keys, screws, or other small metal objects. These items can make a connection from one terminal to the other, shorting the battery terminals together and potentially causing burns or fire.
- Do not abuse or modify the cord of the tool. Replace damaged cords immediately.
- Always hold the tool by the insulated gripping surfaces. Contact with hidden wiring or its own cord will make exposed metal parts of the tool “live” and could shock the operator.
- The wire gauge and length of any extension cord must be able to handle the amps of the tool. Find the amps (A) on the tool’s nameplate and use the chart to determine the necessary wire gauge for your extension cord length.
- Always read and understand the tool’s operator’s manual, tool markings, and the instructions packaged with the accessory before starting any work.
- Stay alert and watch what you are doing when using power tools.
- Do not use drugs, alcohol, or medication while operating power tools.
- Wear clothing that does not have strings or other fabric or design details hanging that could potentially get caught in a machine. This could cause serious injuries and is easy to overlook.
- Contain long hair when operating power tools.
- When not in use, tools should be stored in a dry place.
- Electric tools should not be used in damp or wet locations.
- Keep handles dry, clean, and free of oil and grease.
- Be certain the power tool’s switch is off before plugging it in or inserting a battery pack. Do not carry tools with your finger on the switch.
- Remove adjusting keys and wrenches before turning the tools on.

- Unplug tool and/or remove battery before changing accessories.
- Keep hands away from moving/rotating parts.
- Only use tools and accessories for the jobs for which they were designed.
- Always keep a firm footing when using power tools. Be sure you have balance and control before starting the job.
- Secure and support the workpiece. Use clamps and a stable surface.
- Keep guards in place and working properly.
- Do not force the tool.
- Use only accessories for the tool recommended by the tool manufacturer.
- Use dust collection systems whenever possible.
- Do not use the tool if the switch does not turn it on and off.
- Inspect the tool before using it.
- Tools should be serviced by a qualified repair center. Only use authorized parts for any repairs to the tool.
- Keep the tool clean. Clean and lubricate the tool only as directed in the operator's manual.
- Maintain labels and nameplates.
- Only use sharp blades/accessories on the tools.

PART V Industry Regulations

Specific legislation varies from region to region; be sure you understand the requirements for the country, state, county, or the city in which you are working. Regulations may impact your required working procedures or worker safety, record-keeping, purchasing plans, material disposal requirements, or other areas of your business. In particular, make sure you understand the current regulatory requirements regarding asbestos, lead, formaldehyde, and silica. Being unaware of these laws, or misinformed about how they affect you, can result in fines. The following is a simplified overview to familiarize professionals with the language used and general concepts of several US federal regulations and is not intended as a complete guide to your legal responsibilities. Persons seeking legal advice on compliance with any other law, regulation, or compliance requirement/claim should consult with the regulatory agency directly and/or a qualified legal professional.

- A. **Asbestos** is a naturally occurring silicate mineral that has not been in use in construction for several decades, but can be an issue in older structures. It is composed of thin, fibrous crystals that can be released through abrasion, like sanding, and other processes.



1. When inhaled over long periods of time, asbestos exposure can result in serious and sometimes fatal conditions. These can include asbestosis, mesothelioma, and lung cancer. As a result, asbestos is no longer approved as a modern-day construction material.
2. Asbestos may be present in many older existing homes and structures. Homes or structures built prior to 1986 undergoing renovations should be tested for asbestos.
3. Wood flooring professionals can potentially be affected by asbestos in any remodeling project. If the work is being done in a home or other structure built prior to 1986, you need to be aware of any materials that may contain asbestos, and laws that could impact you.
4. Many states have their own laws regarding asbestos removal, and it is your responsibility to know the laws that are applicable for the area in which you are working. You can find the contact information for asbestos programs in your area at www.epa.gov/asbestos/state-asbestos-contacts.



- B. **Lead** has not been in use in construction for several decades, but can be a concern in older structures during any renovation project.
1. Lead is a naturally occurring chemical element that was used often in many construction products until the late 1970s.

2. Lead-based paint may be found on any surface in the home, both inside and outside. When it is disturbed during renovation, repair, or painting activities, dangerous amounts of lead dust can be created and released into the home or building.
3. Because it can be dangerous, the United States Environmental Protection Agency requires that when renovating, repairing, or painting homes built prior to 1978, they must be tested for lead. This requirement also applies to any non-residential building that primarily serves children, like a school or day care.
4. Wood flooring contractors have to be concerned with two specific areas in homes and other structures built prior to 1978:
 - a. If more than 6 square feet of any painted surface is disturbed (including baseboards), you must test for lead.
 - b. If you are unsure what type of finish is on the floors, you must test for lead. This is because some wood floor finishes produced prior to 1978 contained lead.
5. It is critical that testing take place before any work begins. Before you conduct any testing, your company must be certified to do so by the United States Environmental Protection Agency (EPA). This can be accomplished by following the requirements set forth by the EPA related specifically to the Lead Safety Renovation, Repair and Painting Certification program. You can get more information about the program at www.epa.gov/lead/renovation-repair-and-painting-program.
6. If after testing is completed lead is found to be present, you then must implement lead-safe work practices. To accomplish this, both your company, and the individual doing the work, must be trained by the EPA.
7. Compliance with this law is mandatory nationwide. Fines can be severe, and can range into the hundreds of thousands of dollars per violation.



- C. **Formaldehyde:** The U.S., as well as some individual states and other countries, have strict laws regarding formaldehyde emissions from composite wood products. See resources at the end of this section that will help you understand in detail your responsibilities based on your role in the supply chain.
1. The state of California was the first to significantly regulate formaldehyde emissions from composite wood products, and the program, which the industry refers to as "CARB," was the basis for the federal government's program, known as "TSCA Title VI," now in effect.



2. At the time of publication, both CARB P2 and TSCA Title VI directly regulate emissions from four products (plywood, particleboard, MDF, and thin MDF) and indirectly regulate items produced with those products. Both regulations require these composite wood panels meet specified emissions performance standards, regardless of what resins are used in their production process.
3. All mills producing directly regulated products are required to have a TPC (Third Party Certifier) confirm that their production procedures will lead to the required results.
4. At the time of publication, engineered flooring produced with plywood or MDF cores is covered under TSCA/CARB, as is laminate flooring; however engineered flooring with a lumber-core is not regulated.
5. Both regulations place a documentary burden on all parties in the supply chain to track impacted material and require buyers to exercise reasonable prudent precautions to ensure compliance. There are some differences between the rules, which generally will impact only manufacturers, but companies selling into the state of California should ensure that they are meeting CARB's unique requirements as well as TSCA Title VI. Some specific documentary burdens include:
 - a. Impacted flooring sold in the United States must be labeled to indicate it is TSCA Title VI compliant for formaldehyde emissions. All labels must include, at a minimum, a statement of compliance, a production date, and a name of the manufacturer or other responsible party.
 - b. A compliance statement must appear on transactional paperwork between businesses. The final rule allows for flexibility for panel producers, fabricators, importers, or distributors to choose the document on which to include the compliance statement. They may affix the statement to a bill of lading, invoice, or comparable document; all documents; or any combination

thereof. A statement of compliance is not required on invoices to final consumers.

- c. EPA requires records of production, purchases, and sales to be kept for three years, and made available to EPA upon request.
 - 6. Some mills will use the term “NAF Exempt” or “ULEF Exempt” instead of Certified. This means that they have demonstrated to their TPC that they are using “No Added Formaldehyde” glue and regularly meet a lower emission level than required, or they are making material that is “Ultra Low-Emitting Formaldehyde,” which also means they regularly meet a lower emission level than required. Therefore, they are designated “exempt” from the quarterly testing by a TPC that is required for the regularly certified mills. It does not mean they are exempt from the regulation itself.
 - 7. All parties in the supply chain should understand their responsibilities under these regulations. For more information: www.epa.gov/formaldehyde/formaldehyde-emission-standards-composite-wood-products.
- D. **Crystalline silica** is a common mineral that is a natural part of the Earth’s crust. It is found in materials like soil, sand, and stone. It is used to produce many man-made materials such as concrete and bricks.
- 1. Inhaling silica dust can be harmful to humans. These particles are very small, about 100 times smaller than a grain of sand, so they are not visible to the naked eye. Short-term exposure poses little to no risk, but long-term exposure can result in serious illness, including silicosis, lung cancer, chronic obstructive pulmonary disease (COPD), and kidney disease.
 - 2. Occupational Safety and Health Administration (OSHA) has issued a respirable crystalline silica standard for construction. In the wood flooring industry, the most common source of silica dust is from grinding concrete to level a concrete subfloor, mixing self-levelers and patches to flatten a subfloor, and existing demolition in preparation for wood floor installation.



- a. Under OSHA rules, silica exposure levels are limited to 50 micrograms per cubic meter of air per eight-hours. To meet these requirements, floor grinders must be used according to manufacturer recommendations in order to minimize dust emissions.
 - b. Dust collection systems must provide air flow as recommended by the manufacturer, and have a filter with $\geq 99\%$ efficiency, as well as a filter-cleaning mechanism.
 - c. In enclosed areas, exhaust systems must be used to minimize dust accumulation, and a HEPA-filtered vacuum must be used to remove loose dust in between each pass. Dry sweeping and the use of compressed air to remove silica dust should be avoided.
3. In addition, employers must:
- a. Establish and implement a written exposure control plan.
 - b. Designate someone to monitor the plan.
 - c. Restrict practices that increase exposure.
 - d. Offer medical exams for exposed employees.
 - e. Train workers to identify and limit exposure.
 - f. Maintain records for exposure, medical exams, and other related data.
4. Failure to comply with the regulation can result in significant fines ranging into the tens of thousands of dollars. More detailed information about the Respirable Crystalline Silica Standard for Construction is available from OSHA at www.osha.gov/Publications/OSHA3902.pdf.

INSTALLATION TOOLS



PART I Hand Tools

Hand tools are non-powered. They include anything from hammers to squares. The greatest hazard posed by hand tools results from misuse and improper maintenance. Appropriate personal protective equipment should be worn due to hazards that may be encountered while using hand tools. Common hand tools used in the wood flooring industry include:

- Moisture meters
- Thermo-hygrometers
- Batteries
- Tape measures
- Chalk line
- Pencil/pen
- Squares & straight edges
- Laser level/string-line
- Utility knife
- Prybar
- Wall-jacks
- Straps and clamps
- Chisels
- Nail sets
- Hammer/flooring mallets
- Nail pullers
- Screw drivers
- Trammel points
- Scrapers & files
- Surfacing block plane
- Trowels
- Extension cords
- Tapping blocks
- Pliers and wrenches

PART II Power Tools

There are several types of power tools, based on the power source they use. A power tool is a tool powered by electricity, battery, compressed air, or fuel. Power tools also are classified as either portable or stationary. Appropriate personal protective equipment should be worn due to hazards that may be encountered while using power tools. Wood flooring professionals should be trained in the proper use of all tools and should understand the potential hazards and the safety precautions of each tool. The following are some of the more common power tools used in the wood flooring industry along with some of the options each has to offer.

Dust Collection System

- A. WHAT IS IT: A dust collection system is an air quality improvement system used in industrial, commercial, and home production shops to improve breathable air quality and safety by removing particulate matter from the air and the environment. Each tool should have a collection point where you can attach a collector hose.



- B. TOOL OPTIONS: There are many different types of dust containment systems available. These systems range in size and capacity. Be sure to completely understand the maintenance of the dust collection system as well as its capabilities and limitations when connecting to any power tool. Some installations and jobsites may require use of HEPA or similar regulatory dust containment. Collecting dust from the tools results in a cleaner jobsite and safer environment.



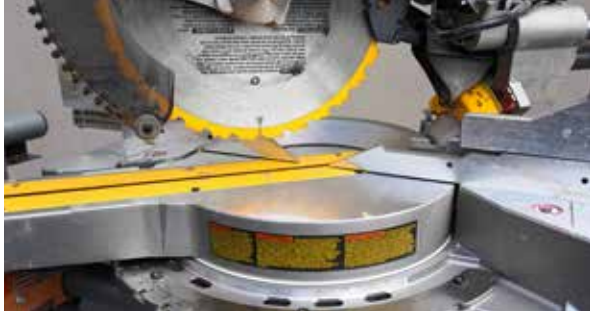

Miter Saws

- A. **WHAT IS IT:** A miter saw sits on a fixed base, with a blade mounted to an arm that can be pivoted from 0 degrees to -45 or +45 degrees. As the name suggests, these saws cut through the work piece at a set miter angle. They are used for crosscutting, mitering, or beveling wood, nonferrous metals, and plastics.
- B. **TOOL OPTIONS:** There are three general types of miter saws: standard miter saws, compound miter saws, and sliding compound miter saws. It is important to understand the capabilities of each type, to determine which is most suitable for your needs.
1. **Standard Miter Saw:** This is the simplest version of a miter saw. It is any wood cutting saw with a blade on an arm, mounted to a base, and capable of making between -45 and +45 degree cross-cut angled cuts.
 2. **Compound Miter Saw:** This saw is capable of cutting both a bevel and miter. A compound miter saw adds the ability to make bevel cuts from 0 to +45 degrees in addition to its mitering ability. There are two types of compound miter saws: single bevel or double bevel options. A single bevel will only tilt in one direction, while a double bevel can go either left or right.
 3. **Sliding Compound Miter Saw:** This saw is a type of miter saw that adds rails to let the saw blade slide front to back across the wood. It gives you a much greater cutting capacity than the same size miter saw without rails. There are two types of sliding compound miter saws: single bevel or double bevel options. A single bevel will only tilt in one direction, while a double bevel can go either left or right.



Table Saws

- A. **WHAT IS IT:** The table saw consists of a circular saw blade, mounted on an arbor that is driven by an electric motor (directly, by belt, or by gears). The blade protrudes upward through the surface of a table, which provides support for the material being cut. They are commonly used for crosscutting, ripping, and other straight cuts, as well as for dadoing and molding.
- B. **TOOL OPTIONS:** There are two basic types of saws: portable and stationary. It is important to understand the capabilities of each type, to determine which is most suitable for your needs.
1. **Portable Table Saws:** There are three general types of portable table saws. Because they are designed to be portable, they are normally smaller and lighter weight.
 - a. Bench-top Saws: smaller rip capacity and table, with no stand or transport wheels.
 - b. Compact Saws: may include features such as stands, or surfaces made of cast iron.
 - c. Jobsite Saws: heavier duty components that can produce more accurate results, and often larger rip capacity.
 2. **Stationary Table Saw:** There are three basic types of stationary table saws. Compared to portable saws, they are much larger and heavier, more accurate, and more powerful. They are not really portable, although they can be mounted to a mobile base for transportation around the workshop.
 - a. Contractor Saws: a cheaper alternative to a full-size cabinet saw that may weigh as much as 200-300 lbs. They are much more powerful than a portable saw.
 - b. Cabinet Saws: Cabinet saws are extremely precise, heavy, bulky, and made to last for decades. Each component of a cabinet saw is designed to be durable and robust, and to withstand heavy-duty use.
 - c. Hybrid Saws: Hybrid table saws offer some of the advantages of cabinet saws at a lower price than traditional cabinet saws. Hybrid saws offer an enclosed cabinet to help improve dust collection. The cabinet can either be similar to a cabinet saw with a full enclosure from the table top to the floor or a shorter cabinet on legs.

Band Saws

A. **WHAT IS IT:** The band saw is a saw with a long blade that consists of a continuous band of flexible steel with saw teeth, stretched between two or more idler wheels. Band saws cut fast and accurately due to continuous tooth blade action and a slow-moving blade, which allows for more finesse and control. The blade comes down from an upper wheel, through a bearing/saw guide yoke and into an opening in the table to a lower wheel. The table is where the workpiece is moved into the moving saw blade to create cuts. While the blade is continuously moving, only a small part of it should be exposed by adjusting the elevation of the guide post, which holds a blade guard above the cutting area.



- B. **TOOL OPTIONS:** In general there are three types of band saws used with flooring installations: floor standing, benchtop, and portable. It is important to understand the capabilities of each type, to determine which is most suitable for your needs.
1. **Floor Standing:** powerful saws with a larger workspace, table size, and positioning capabilities, for use when making more-intricate cuts or ripping larger boards.
 2. **Benchtop:** Benchtop band saws are more-mobile versions of floor standing models.
 3. **Portable:** Portable band saws are about the size of a handheld circular saw and are mostly used for jobsite work, often trimming excessive pieces off.



Circular Saws

A. **WHAT IS IT:** A circular saw consists of a motor, blade, blade guard, and a base. It is a power tool that cuts materials using a round-toothed or abrasive blade. They are available in corded or cordless options. Most circular saws used in the wood flooring industry are hand-held types, and are specifically used to cut wood. These saws may also be equipped with blades designed

to cut masonry, plastics, or metal. The most common-size blade used for cutting wood and framing is 7¼" designed for crosscuts or rips in various wood and synthetic rigid materials.

- B. **TOOL OPTIONS:** Circular saws are available in many styles:
1. **Sidewinder/In-Line Circular Saws:** This is the most-common type of circular saw used. The motor is normally mounted on the side of the blade, making it a compact tool. The blade rotation speed is either 1,725 or 3,450 RPM, based on the motor direct-drive rotation speed.
 2. **Worm Drive and Hypoid Circular Saws:** The motor is mounted toward the back of the tool, making it significantly longer and heavier than a sidewinder. The gears of these saws are what differentiate them from each other, but provide more torque than a sidewinder. The blade rotation speed is normally about 4,500 RPM. The blade is normally positioned to the left side of the motor.

Plunge-Cut Saw/ Track Saw

- A. **WHAT IS IT:** A plunge-cut saw has a blade that spins and cuts similarly to a circular saw, but with a fixed guard, which provides superior dust collection and safety features. The saw moves in a metal track along a straight line. When you want to cut, simply attach the metal track on to the workpiece, place the saw on the track, then plunge the saw into the work-piece and move it forward along the guide (or the track).
- B. **TOOL OPTIONS:** Many plunge-saws have variable speeds, which allow for cutting through a variety of materials. The track comes in many length options. These saws are designed for plunging into a material, and most have a depth setting for precision cuts.



Oscillating Saw (Multi-Tool)

- A. **WHAT IS IT:** An oscillating saw is a compact, corded or cordless, portable power tool that accepts a wide range of interchangeable blades. Because of the tool's short range of blade motion, small front-end profile, and blades that extend past the snout of the tool, it reaches in to places other power tools can't, including narrow spaces, tight corners, and awkward angles.



- B. **TOOL OPTIONS:** Most oscillating saws offer variable speeds. The blade vibrates– or oscillates– back and forth at very high speed (from 11,000-21,000 oscillations per minute). This tool is often called a multi-tool due to the wide variety of tasks it can perform, including cutting, scraping, rasping, sanding, polishing, and grinding.

Reciprocating Saw

- A. **WHAT IS IT:** A type of saw in which the cutting action is achieved through a “push and pull” reciprocating motion of the blade. It is generally used in demolition work.



- B. **TOOL OPTIONS:** These saws may be used to cut metal, pipes, wood, nail-embedded wood, and other materials dependent upon the blade being used. Many reciprocating saws also have an orbital action setting, which moves the blade in a slightly circular motion as it moves in and out of the tool. This allows faster cuts in softer materials and facilitates faster chip removal from the blade path.

Jigsaw (Saber Saw)

- A. **WHAT IS IT:** A jigsaw is a saw that uses a reciprocating blade to cut straight lines or irregular curves in wood. It will also make interior cuts, or cuts within a board without cutting through the work from an outside edge.



- B. **TOOL OPTIONS:** Most jigsaws come with variable speed options, which allow for adjustment based on the material being cut. Most blades cut on the upstroke, which is good when used for rough cutting. Reverse-tooth blades have downward facing teeth, which produce clean cuts on the face of the board. These saws also have an adjustable base that allows for beveled cuts to be made through the wood.

Scroll Saw

- A. **WHAT IS IT:** A scroll saw is a small electric or pedal-operated reciprocating saw used to cut fine, intricate



profiles and patterns. The fineness of its blade allows it to cut more delicately than a jigsaw. Scroll saws come with a variable speed control to modulate the rate of cut through materials and for adjusting to various blade-cutting capabilities.

- B. **TOOL OPTIONS:** The throat size determines the size of the workpiece capable of being cut. Throat size can vary from 12” to 30” or more. Most scrolls saws offer a small light on a flexible arm that illuminates the work area and a dust blower nozzle to keep the work space clear while working.



Router

- A. **WHAT IS IT:** A machine with a revolving vertical spindle and cutter for milling out the surface of wood. Routers are used as a “hand-shaper” to create profiles, decorative cuts, shaping, making joints, and trimming wood.

- B. **TOOL OPTIONS:** Most routers have a variable speed option to adjust based on the material being cut. Routers normally have either a ¼” or ½” collet, which will determine the bit used with the tool. Routers can be divided into two general groups: fixed-base and plunge-base routers.

1. **Fixed-Base Routers** are locked at a fixed location in the base, and the cutting bit cannot move, or plunge, from top to bottom. These routers are commonly used as router tables, where they are mounted underneath a stationary table.
2. **Plunge-Base Routers** move up and down on the base, which has spring-loaded arms on either side that allow the user to manually “plunge” the cutting bit down into the material from above.

Drill/Driver

- A. **WHAT IS IT:** A hand-held tool that has a chuck (keyed or keyless) used to hold bits in place for drilling, driving, or hammering.



- B. **TOOL OPTIONS:** There are many types of drills and drivers, but for the purposes of the wood flooring industry, we will focus on these general categories: drills, impact drivers, hammer drills/rotary hammers, and drill presses.

1. **Drills** are used to create a hole with a rotating drill bit into a material. Drills are rated by the maximum capacity of their chuck.

2. **Impact Drivers** have a rotary impulse mechanism that allows the tool to drive fasteners into a material.



3. **Hammer Drills/ Rotary Hammers** use an impacting/hammering action in combination with, or without, rotation. These drills use specially designed bits to drill holes into masonry materials or for demolition.



4. **Drill Press** is a mounted style of drill that includes a base, column (or pillar), adjustable table, spindle, chuck, and drill head.



Grinder (Handheld and Bench)

- A. **WHAT IS IT:** Grinders are highly versatile tools capable of accepting a variety of attachments and accessories that allow the tool to be used for cutting, grinding, sanding, polishing, sharpening, or wire brushing.

- B. **TOOL OPTIONS:**

1. **Handheld Grinder** attachments include cut-off discs, abrasive grinding discs, sanding discs, wire brush wheels, grinding stones, and polishing pads. Attachments are normally available in 4", 4.5", 5", 6", 7", 9", and 12" sizes.



2. **Bench Grinders** are mounted to a bench or pedestal, and used specifically to drive abrasive wheels. They normally are used for sharpening cutting tools, cleaning or polishing workpieces, or for rough shaping metal pieces.



Guillotine-Style Shear Cutter

- A. **WHAT IS IT:** A non-powered, compact guillotine-style cutting tool designed to cut through thin-profile engineered



wood flooring as well as other types of flooring materials. These cutters have a long handle that provides the leverage necessary to cut through different types of flooring.

- B. **TOOL OPTIONS:** These cutters are available in different sizes to accommodate different types of flooring. Due to the nature of how these cutters work, there is no power necessary to operate the tool, and no dust produced during operation.

Floor Roller

- A. **WHAT IS IT:** A non-marking, segmented roller, required with some adhesives, that exerts even pressure on a glued-down wood floor, cork, or underlayment, ensuring that the adhesive is transferred to the back of the installed floor.



- B. **TOOL OPTIONS:** Floor rollers are available in different sizes and different weights. The weight is determined by the adhesive manufacturer.

PART III Pneumatic Tools

Pneumatic tools are powered by compressed air.

Air Compressors

A. **WHAT IS IT:** Air compressors are tools that convert power into stored energy in the form of compressed air.

B. **TOOL OPTIONS:**

1. **Tank Capacity (gallons):** For small jobs like installing trim or flooring repairs, the pneumatic guns can operate on the air supplied by a relatively small tank. For most wood floor installations, more air is required to be delivered to the constant demand of a flooring nailer. When more than one gun is being used on one compressor, a larger tank will also be required. The larger the tank, the longer the job can be done at the required PSI before the compressor needs to rebuild pressure in the tank.
2. **Oil or Oil-free:** Oil-free designs are most common and require less maintenance.
3. **SCFM:** Standard Cubic Feet per Minute (SCFM) is a measure of air (under standardized conditions) being delivered by the compressor to the air tool. Compressors with a higher SCFM rating provide more air. SCFM requirements should be dictated by the tools being used.
4. **PSI:** Pounds per square inch is the measure of air-force delivered by the compressor. For one flooring nailer to operate, the compressor should be able to continuously deliver 80-110 PSI at 3½" cubic feet of air per minute.



Hoses

A. **WHAT IS IT:** Compressor air hoses are used for conducting compressed air to the tool.

B. **TOOL OPTIONS:**

1. **Hose size** is measured by its inner diameter. Most pneumatic nailer manufacturers recommend the use of a minimum 3/8" diameter hose supply connectors and a 50' or smaller hose.



2. **Fittings:** Hose connections should be designed for the pressure and service indicated on the tool. All connectors and couplers should be compatible with and designed for the hose and tool being used.

Flooring Nailers

A. **WHAT IS IT:** A type of tool used to drive flooring nails or staples into wood flooring.

B. **TOOL OPTIONS:**



1. **Mallet-Actuated Nailers/Staplers:** Flooring nailers are mallet-actuated nailers capable of driving staples or flooring cleats/nails into the tongue of a piece of wood flooring. Each model has different capabilities and magazine cartridges for use with specifically designated fasteners.



2. **Trigger-Activated Nailers/Staplers** are engaged by a trigger and capable of driving the flooring fastener into the tongue of a piece of wood flooring. Each model has different capabilities and magazine cartridges for use with specifically designated fasteners.

3. **Manual Nailers** are not powered using compressed air, but rather plunger-driven by blunt force. These may be available as multi-hit or ratcheting mechanism to allow the user to strike multiple times.



Pneumatic Nailers

A. WHAT IS IT: A type of tool used to drive nails into wood or some other kind of material.

B. TOOL OPTIONS:

1. **Finish**

Nailers:

Available as pneumatic or electric.

These nailers drive 14g to 16g nails, upwards of 2½" in length.

They normally are used where flooring nailers cannot be used.



2. **Brad Nailers:** Available as pneumatic or electric. These nailers drive 18g brads, upwards of 2" in length, leaving smaller holes in the surface of the board.

They normally are used where flooring nailers cannot be used, or for temporary hold power while adhesive sets up.



3. **Pin Nailers:** This is the smallest nailer in the trim-nailer family. These nailers normally drive 23g, headless nails, upwards of 2" in length.

These fasteners leave a very small hole in the surface of the board, oftentimes not needing to be filled. They normally are used for temporary hold power while adhesives set up, or for delicate trim work.



PART IV Blades and Bits

Circular Saw Blades

A. Blades used for miter saws, table saws, circular saws, and radial arm saws.

B. Saw teeth may be made of steel or carbide.



C. The cutting edge of each tooth is ground to a specific profile, which controls how it cuts. Flat teeth shave the wood fibers like a plane, beveled teeth cut them in two like a knife, and triple-chip teeth are mixed with flat teeth to cut tough materials. The mix of teeth on a blade is known as the grind.

D. **Ripping blades** are used for cutting parallel to wood grain, ripping to width. These blades have a large hook angle (20-25 degrees). These blades have fewer teeth and wide gullets, and are most commonly used with table saws.

E. **Crosscut blades** are used for cutting across the wood grain, cutting to length. These blades have a small hook angle (5-10 degrees). These blades have more teeth and narrow gullets, and are more commonly used with miter saws.

F. **Combination blades** are used for ripping and crosscutting wood. These blades have teeth arranged in sets of five - first a ripping tooth preceded by a wide gullet, then four crosscut teeth with narrow gullets. The hook varies between 5-25 degrees, depending on the tooth. These are commonly used with circular saws, and miter saws.

G. **Plywood blades** are used for cutting plywood. They are designed to make smooth cuts. These blades have small hook angles (5-10 degrees) with narrow gullets. For cutting hardwood veneer plywood, the blades normally have 80 or more small teeth, whereas when cutting OSB or other substrate plywoods, a more-aggressive blade configuration can be used, such as 24 tooth blades.

H. **Hollow ground planer blades** normally are used for sawing operations requiring a smoother cut. They have the same hook angle and tooth arrangement as combination blades, but the teeth have no set, and are only available in steel (not carbide).

I. **Thin-kerf blades** are used for ripping or crosscutting hardwood. They are available in rip, crosscut, and combination configurations, and are carbide-tipped only. The plate and teeth are approximately 2/3 the width of ordinary blades.

Bandsaw Blades

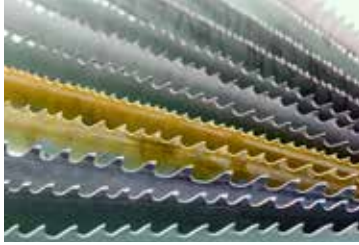

- A. **Standard-tooth blades** are best used for crosscutting, joinery cuts, and smooth surfaces. These also have more teeth per inch and can cut slower and smoother than other blades.
- B. **Skip-tooth blades** are best used for cutting curves and contours, or thick stock. The teeth have the same profile as standard blades, but are spaced much further apart. These blades also cut much faster.
- C. **Hook-tooth blades** are best used for ripping, resawing, cutting green or resinous wood, or thicker stock. The pitch is the same as the skip-tooth blade, but the rake angle is about 10 degrees, which allows for a more-aggressive cut.

Jigsaw Blades



- A. Blades vary in their effective cutting length, number of teeth per inch (tpi), and manner in which the teeth are set.
- B. **General Purpose:** 6-8 tpi, used for rough cuts in wood.
- C. **Smooth Cut:** 6-8 tpi, used for clean cuts in wood.
- D. **Plywood:** 12-14 tpi, used for cutting sheet materials.
- E. **Detail:** 12-14 tpi, used for cutting more-intricate patterns.
- F. **Laminate:** 10-14 tpi, reverse teeth used to cut laminated material on the down stroke.
- G. **Offset:** 6-8 tpi, offset blade used for cutting up to a corner.

Scroll Saw Blades



- A. **Scroll blades** for heavy-duty work in wood and soft metals (standard tooth).
- B. **Fret blades** for fine work in wood and soft metals (includes skip tooth, double-skip tooth, and reverse skip tooth).
- C. **Precision-ground blades** for cleaner cuts and better control (includes skip tooth).

- D. **Metal-cutting blades** for work in metals (standard tooth).
- E. **Spiral blades** for omnidirectional cuts in wood and soft metals (standard tooth).



Router Bits

- A. A router bit consists of a cylindrical shank and one or more flutes that cut the work. Bit flutes may be made of steel or carbide.
- B. Most bits have straight flutes. Bits with shear flutes leave a smoother cut, whereas bits with spiral flutes help clear material from plunge cuts. Stagger-tooth and chip-breaker flutes are made to cut plywood and particleboard.
- C. Some bits have pilot bearings, either on the top or bottom of the cutter head, to guide the bit along the edge of the work or template. Unpiloted bits may have top-cutting flutes or point-cut flutes that allow you to plunge into the wood.
- D. Although there are hundreds of types of router bits, they can all be organized into two categories:

1. **Groove-forming bits**, which cut grooves, dados, mortises, and recesses in the work.
2. **Edge-forming bits**, which cut rabbets, bevels, ogees, and other shapes around the perimeter of the work.





WOOD FLOORING PRODUCT

PART I Wood Flooring Options

Wood is the hard fibrous material that forms from the main substance of the trunk or branches and beneath the bark of a tree. A wood floor is any flooring product that contains real wood as the top-most, wearable surface of the floor.

Wood floors come in many different options. These include, but are not always limited to, the following:

Hardwood/ Softwood

- A. **Hardwoods** come from deciduous, broad-leaved trees that lose their leaves annually. Hardwood comes from angiosperm trees. Angiosperm trees produce enclosed seeds such as pecans, acorns, or walnuts. Hardwood trees include oak, maple, ash, cherry, and others.
- 
- B. **Softwoods** come from conifers, which are needle-bearing and usually remain green throughout the year. Softwood comes from gymnosperm trees. Gymnosperm trees produce uncovered seeds, such as pinecones. Softwood trees include pine, spruce, Douglas fir, cedar, and others.
- 
- C. It's important to remember that being hardwood or softwood does not necessarily reflect density. Some softwoods are harder than hardwoods and some hardwoods are softer than softwoods.

Domestic/Imported

- A. **Domestic woods** are wood species grown and harvested within the United States and Canada.
- B. **Imported woods** (also known as exotic or tropical species) are wood species grown and harvested outside the United States and Canada.

Solid/Engineered

A. Solid Wood Flooring

1. Solid wood flooring is exactly what the name implies, a solid piece of wood from top to bottom.
2. Solid wood floors can be sanded and refinished numerous times during their service life.
3. Solid wood floors should not be installed below grade, which means below ground level, unless otherwise recommended by the manufacturer.



B. Engineered Wood Flooring

1. Engineered wood flooring is real wood flooring as well, but instead of a solid piece of wood from top to bottom, it is made using several layers of wood veneers or lumber core that are bonded together using adhesives.
2. No matter what the thickness of the engineered product, it is the top layer that determines the final appearance of the wood floor. This wear layer will be the species of wood that is selected.
3. The construction of engineered wood flooring can vary. The construction varies by manufacturer and by product.
4. The thickness of the finished product can range from 3/8" to 3/4".
5. The top layer of engineered wood flooring typically is referred to as lamina or lamella. Each layer is bonded to adjoining layers using adhesive.
6. The middle layers, which are called core layers, can be made of the same species as the wear layer, or an entirely different species. The bottom layer is called the backing.
7. In general, due to its' construction, engineered wood flooring can be installed above- on- or below-grade.



C. Engineered Composite Wood Flooring

1. Engineered composite wood flooring uses real wood on the wearable surface that is bonded to a multitude of composite platform materials using adhesives.
2. In general, due to its construction, engineered composite wood flooring can be installed above- on- or below-grade.



Jobsite-Finished/Factory-Finished

- A. Jobsite-finished floors are manufactured and installed in a raw state and sanded and finished on-site.
- B. Factory-finished floors are just as the name implies. The flooring has finish applied at the factory prior to installation.



Strip/Plank/Wide Plank/Parquet

- A. Strip wood flooring is manufactured in linear widths less than 3".
- B. Plank wood flooring is manufactured in linear widths greater than or equal to 3", and less than or equal to 5".
- C. Wide plank wood flooring is manufactured in linear widths greater than 5".
- D. Parquet flooring is any pattern that is geometric in shape as opposed to linear. The traditional finger block pattern is a very common and simple parquet pattern, but parquet can vary in style, width, complexity, and pattern.

Saw Cut

How wood is cut from the log will affect appearance and performance of wood flooring. There are several sawing methods used for the production of both solid and engineered wood floors.

- A. **Plainsawn/Flatsawn:** Wood cut parallel to the growth rings so that the growth rings are mostly parallel (0° to 45°) to the wide face of the board (a tangential cut) is called plainsawn in hardwoods, and flatsawn in softwoods. Plainsawn flooring is more dimensionally stable in thickness (radially) and less stable in width (tangentially).



- B. **Riftsawn/Bastard-Sawn:** Wood cut neither parallel nor perpendicular to the growth rings so that the growth rings make angles of 30° to 60° to the face of the board is called riftsawn in hardwoods, and bastard-sawn in softwoods.



- C. **Quartersawn/Vertical-Grain:** Wood cut perpendicular to the growth rings so that the growth rings are mostly perpendicular (45° to 90°) to the wide face of the board (a radial cut) is called quartersawn in hardwoods, and vertical-grain in softwoods. Quartersawn lumber is more dimensionally stable in width (radially) and less stable in thickness (tangentially).



- D. **Livesawn:** Wood cut from the outside diameter through the heartwood incorporating the full range of the above characteristics on the face of the board is known as live-sawn material. This cut is typically wider and incorporates all of the dimensional stability and aesthetic characteristics of the other cuts.



E. **End-Grain:** Wood cut so that the face of the floor surface exposes the ends of the growth rings is the transverse cut, more often known as end-grain. End-grain flooring will shrink and swell according to the tangential value in the direction across the circumference of the growth rings and according to the radial value in the direction perpendicular to the growth rings, with essentially no movement in thickness.



F. **Sawn Veneers:** With engineered wood flooring, the top veneer (or lamina) is sawn in the same way as normal solid wood flooring, and is available in any of the cuts previously mentioned. The only difference is the thickness of the cut, which varies from product to product.

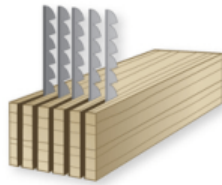

G. **Sliced Veneers:** With engineered wood flooring, the top veneer is sliced from the lumber (called a cant). This process of producing veneers has thickness limitations and can stress the wood fibers, but has very similar natural, physical, and strain characteristics as a sawn veneer.



H. **Rotary-Peeled Veneers:** With engineered wood flooring, the top veneer is produced by positioning full logs onto a large lathe, which spins the log against a sharp blade, producing a distinct, purely tangential grain-pattern. The grain pattern repeats on larger sheets.

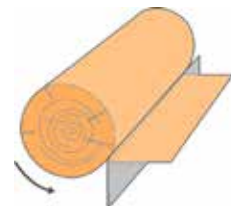

Grade

- A. Grading is an essential part of doing business in the hardwood floor industry. Grades group flooring with similar qualities, bringing a degree of consistency to products from different mills. Grades tell the purchaser what to expect when buying product, including surface characteristics, required lengths, and milling tolerances.
- B. Grades are established through industry mill certification programs such as NOFMA (formerly

the National Oak Flooring Manufacturer's Association, and Wood Flooring Manufacturer's Association; currently the wood flooring mill certification program administered by the NWFA), or by hardwood flooring manufacturers that determine their own classifications and create their own grades, or "proprietary grades."



Beveled edges

- A. Beveled edges are a feature of most factory-finished wood floors. A bevel refers to an edge of a board that is not perpendicular to the face.
- B. The degree of beveling varies depending on the manufacturer and the specific product. Typical bevel styles include the following:
 - Square edge
 - Full bevel
 - Micro bevel
 - Pillowed bevel
 - Chiseled edge

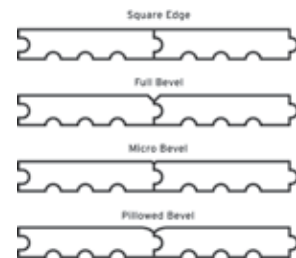

Antique Reclaimed/Recycled/Salvaged

- A. **Post-Consumer Recycled/Antique Reclaimed Wood:** Wood or wood fiber that has been reclaimed from an end-user after being used for its original intended purpose. End-users may include individuals, households, or industrial users of the product.
- B. **Pre-Consumer Recycled Wood:** Wood or wood fiber that is created as a by-product of a secondary manufacturing process and is not typically re-used on-site in the same process that generated it (also called post-industrial recycled wood).



- C. **Salvaged Wood:** Wood or wood fiber that comes from logs that have been salvaged from the following sources: post-agricultural (e.g., fruit and nut orchards); urban forests (street trees); waterways (sunken logs raised from rivers, reservoirs, and lake bottoms); and other sources that are otherwise not intended to be harvested.



Other (Non-Wood) Flooring Products

A. Cork Flooring

1. While cork technically is not considered a hardwood, it does come from a tree. Cork comes from the cork oak tree. While wood flooring is harvested by using the wood of the tree, harvesting cork utilizes the bark of the tree.



2. Cork is a natural product that remains largely unchanged by processing. It is a naturally fire-resistant material that does not release any toxic gases during combustion.
3. Cork absorbs ambient sound, which makes it an excellent sound insulator. Because it has an elastic nature and miniature cell composition, cork is an extremely durable flooring material. Cork resists the growth of mold, mildew, and bacteria. It also repels bugs and dust mites due to the presence of a naturally occurring substance called suberin.

B. Bamboo Flooring

1. Bamboo is not wood; it is a grass. It is one of the fastest growing plants in the world. In fact, some shoots have been observed to grow more than three feet in a single day. Bamboo can regrow itself without replanting, so it is a highly sustainable resource.
2. Bamboo is one of the oldest building materials known to man.
3. Bamboo flooring comes in three common styles: vertical, horizontal, and strand-woven.



PART II Trim and Mouldings

Mouldings are used to cover the expansion area, to hide cut ends, to adjust height differences or transitions between floors, and to aesthetically finish the area. Profiles, species, and availability vary through the industry.

Baseboard Mouldings (Skirting Board)

Baseboard mouldings are used where the floor and walls meet. They form a visual foundation and are important in establishing the character of a room. Traditional baseboard profiles measure from 3/8" to 3/4" thick, and vary in height. Functionally, they protect the walls from kicks, bumps, furniture, and cover perimeter expansion space where the floor meets the wall.



Base Shoe (Shoe Moulding)

A narrow moulding that is normally used in conjunction with, or instead of, baseboard to conceal the required expansion space between the wall, cabinets, or steps, and the wood flooring. It is flexible enough to conform to irregular surfaces. Base shoe profiles normally measure from 3/8" to 5/8" thick, and can vary from 1/2" to 1" in height. It is important when installing base shoe to avoid nailing it to the flooring. Only nail it to the wall or baseboard.



Quarter Round

Quarter round is, as the name insinuates, one quarter of a full round. It is normally used as an alternative to base shoe to conceal the required expansion space between the wall, cabinets, or steps, and the wood flooring. It is important when installing quarter round to avoid nailing it to the flooring. Only nail it to the wall or baseboard.



Reducer

Reducers are used to provide a smooth transition between floors of uneven heights. Reducers are often used between wood floors and thinner floor coverings such as vinyl or low pile carpet. It also can be used to cover expansion space around vertical surfaces such as fireplace hearths when mounted directly to the surface of the flooring. Reducer profiles normally measure from 5/16" to 3/4" thick, and can vary from 1" to more than 3 1/2" wide.



Overlap Reducer

Overlap reducer is typically used in floating floor installation methods. This multi-purpose moulding is used to provide a smooth transition between floors of different heights, or different types of flooring. Overlap reducer should never be fastened to the wood flooring. It must be attached only to the subfloor, in order to maintain adequate expansion space.



Threshold (Baby Threshold)

Thresholds are designed for the transition between floors of different heights, and are commonly used to make the transition at doorways, between interior rooms, and to the outside. Threshold profiles normally measure from 5/16" to 3/4" thick, and can vary from 1" to more than 3 1/2" wide.

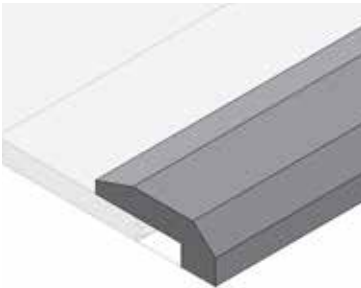

T-Moulding

T-mouldings are commonly used to join two areas of flooring that are the same thickness or to join floating hardwood floors between two rooms, in doorways, or where the flooring manufacturer requires additional expansion space based on the floor span. T-moulding can also be used to conceal concrete construction joints or internal expansion joints left during the installation. T-moulding should never be fastened to the wood flooring. It must only be attached to the subfloor, in order to maintain adequate expansion space.



Nosing (Stair Nosing, Bullnose, Landing Tread)

Nosing is the horizontal, protruding edge of a stair where most foot traffic frequently occurs.

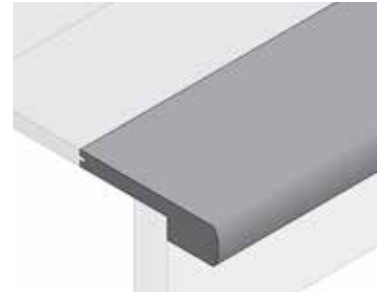

The nosing provides a transition from the floor level to any space below the floor elevation. It starts flush with the flooring and makes a finished edge on the outer face. They are used to cover the outside corner of a step, milled to meet the hardwood floor in the horizontal plane, or to meet the riser in the vertical plane. Be sure to check with local building codes for stair nosing overhang, rise/run, and proper installation requirements for stair nosing.

Overlap Stair Nosing

Overlap stair nosing normally is used with floating floor installation methods, where the flooring meets a step down or landing.

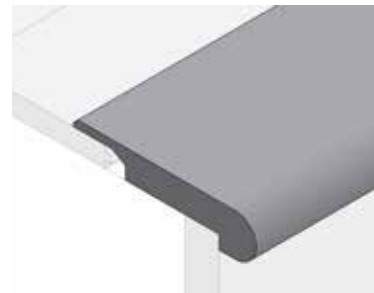

It is used to protect the edges and provide a finished look. It is different from flush stair nose; overlap step nose has a slightly raised profile that overlaps the flat flooring surface, in order to maintain adequate expansion space. Be sure to check with local building codes for stair nosing overhang, rise/run, and proper installation requirements for stair nosing.

Stair Tread

The horizontal part of a stair upon which the foot is placed.



A. **Solid stair treads** are pieces of wood that are used as the actual stair steps themselves or, more commonly, to cover the existing sub treads beneath.

B. **False tread end caps** are used to create the look of steps with solid treads and a carpet runner. In this case, caps are placed at one or both sides of the stair and it is carpeted in between.



C. **Overlay stair treads** are used specifically to cover existing sub treads with less impact on the height/rise gain in a remodel project.



Stair Riser

The vertical component of a step filling the space between the treads



Floor Vents

A. **Self-Rimming Vents (Drop-In):** A floor vent that drops into an existing HVAC vent. These vents normally overlap the floor on all four sides, and easily replace the builder-grade metal vents in any floor. These vents normally are available in any species, in any size, and with or without dampers.



B. **Flush-Mount or Trim-Line Vents:** A floor vent that is installed flush with, or cut into, the wood floor. They may contain a frame in which the removable vent rests. These vents are normally



available in any species, any size, and any thickness to match different flooring profiles, and with or without dampers.

C. **Horizontal Baseboard Registers:** A baseboard vent that is installed with the replacement of baseboard mouldings where wall ventilation exists. They are often used to replace the builder-grade metal baseboard vents. These vents are normally available in selected species and at standard wall vent sizes, with or without dampers.

Custom Mouldings

Mouldings created for unusual circumstances may be manufactured to jobsite requirements to complement the wood floor and allow for proper transition and coverage of expansion space. Custom mouldings can be custom milled to any shape or size, overlapping or flush, and out of any material.

PART III Packaging

- A. Factory-finished hardwood flooring is normally packaged in cartons or boxes.
- B. Unfinished hardwood flooring is usually packaged in bundles. Bundles may be available in two types: bundled flooring (also referred to as "random-length bundles") and nested bundles.
 1. **Bundled flooring** consists of flooring pieces that range from 6" +/- the nominal length of the bundle. A run in bundled flooring is a single piece of flooring.
 2. **Nested bundles** consist of flooring that is placed end-to-end continuously in runs, with the run length equaling the 6" +/- nominal bundle length.
- C. **Square Foot:** Most wood flooring is packaged in square feet or square meters. This is the area that the flooring will cover.
- D. **Board Foot:** A board foot is a measurement of volume that is 12" by 12" by 1" thick. The board foot measurement indicates the amount of lumber necessary to create flooring from a board.
- E. **Lineal Foot:** Lineal foot is a measurement used for ordering material when length is the only concern. Baseboards, transitions, feature strips, and borders are examples of materials commonly ordered by the lineal foot.
- F. **Equal Lineal Foot:** Random-width plank flooring laid in a repetitive pattern normally is ordered by the equal lineal foot to ensure that the floor gets the same length of each width of flooring.
- G. **Cubic Foot:** A cubic foot (or 12" by 12" by 12") is a measurement normally only used when flooring is being shipped in containers or via airfreight, making volume a concern.

PART IV Conversions and Calculations

- A. Square Footage in a Bundle: (# of runs X bundle length in feet X width in inches)/12 = ft².
- B. Square Footage to Lineal Footage: (square feet X 12)/width in inches = lineal footage.
- C. Equal Lineal Footage (for Multiple-Width Flooring): Total square footage/total pattern width X width in question = ft².
- D. Average Length (with nested bundles): total lineal feet/# pieces.
- E. Average Bundle Length (of bundled flooring): total lineal bundle feet/# of bundles.
- F. Converting fractions, decimals, and millimeters:

Fraction - Decimal - Metric (mm)		
FRACTION	DECIMAL	METRIC (MM)
1/64	.0156	.4
1/32	.0313	.79
3/64	.0469	1.19
1/16	.0625	1.59
5/64	.0781	1.98
3/32	.0938	2.38
7/64	.1094	2.78
1/8	.1250	3.18
9/64	.1406	3.57
5/32	.1563	3.97
11/64	.1719	4.37
3/16	.1875	4.76
13/64	.2031	5.16
7/32	.2188	5.56
15/64	.2344	5.95
1/4	.2500	6.35
17/64	.2656	6.75
9/32	.2813	7.14
19/64	.2969	7.54
5/16	.3125	7.94
21/64	.3281	8.33

Fraction - Decimal - Metric (mm)		
FRACTION	DECIMAL	METRIC (MM)
11/32	.3438	8.78
23/64	.3594	9.13
3/8	.3750	9.53
25/64	.3906	9.92
13/32	.4062	10.32
27/64	.4219	10.72
7/16	.4375	11.11
27/64	.4219	10.72
7/16	.4375	11.11
29/64	.4531	11.51
15/32	.4688	11.91
31/64	.4844	12.30
1/2	.5000	12.70
33/64	.5156	13.10
17/32	.5313	13.49
35/64	.5469	13.89
9/16	.5625	14.29
37/64	.5781	14.68
19/32	.5938	15.08
39/64	.6094	15.48
5/8	.6250	15.88
41/64	.6406	16.27
21/32	.6563	16.67
43/64	.6719	17.07
11/16	.6875	17.46
45/64	.7031	17.86
23/32	.7188	18.26
47/64	.7344	18.65
3/4	.7500	19.05
49/64	.7656	19.45
25/32	.7813	19.84
51/64	.7969	20.24
13/16	.8125	20.64
53/64	.8281	21.03
27/32	.8438	21.43
55/64	.8594	21.83
7/8	.8750	22.23
57/64	.8906	22.62
29/32	.9063	23.02
59/64	.9219	23.42
15/16	.9375	23.81
61/64	.9531	24.21
31/32	.9688	24.61
63/64	.9844	25.00

INVOLVED PARTIES

The guidelines defined in this chapter generally are considered to be typical responsibilities of each involved party within the supply-chain. It is important to identify each of the relevant parties, along with their specific roles, prior to beginning each flooring project. Each party may be referenced by an alternative name or classification, may have more than one designation, or may be called something different from what is defined in this chapter. Defining responsibility will help all involved parties clearly understand their roles in the process, and assist in minimizing potential future claims.

PART I Involved Party Definitions

Manufacturer: Any individual or entity that physically manufactures a product, or has a product designed or manufactured for the wood flooring industry, and places it on the market under its' own name or trademark.

Specifier: Any individual or entity (including, but not limited to, architects, builders, consultants, design centers, interior designers/decorators, end-users, general contractors, flooring contractors, sales professionals) that recommends, specifies, or in any way advises the buyer prior to ordering, purchasing, and/or installing the wood floor products.

Supplier: Any individual or entity (including, but not limited to, distributors, wholesalers, importers) that receives product from a manufacturer and supplies the wood flooring products to a reseller or buyer.

Seller: Any individual or entity (including, but not limited to, retail stores, big box stores, internet sales, interior designers, vendors, direct sales) that physically supplies/sells the wood flooring products to the buyer.

Buyer: Any individual or entity (including, but not limited to distributors, end-users, installers, flooring contractors, general contractors) that is the first to use/handle/possess/receive/deliver the wood flooring material prior to installation of the wood flooring product.

Builder: Any individual or entity (including, but not limited to homebuilders, remodelers, general/restoration contractors, DIYers) that coordinates and oversees the different suppliers, trades, installers, and other experts involved in building or remodeling a home, office, or other building.

Installer: Any individual or entity that physically installs and places into service the wood flooring product.

End User: Any individual or entity that physically receives and uses the final wood flooring product.

PART II Involved Party Responsibilities

A. Manufacturer Responsibilities

1. It is the responsibility of the **Manufacturer** to produce a product, that will perform as it is marketed and intended to perform based on the instructions provided.
2. It is the responsibility of the **Manufacturer** to design and manufacture a product in accordance with all standards and regulations that apply to the product being sold.
3. The product should contain labels identifying its contents, and should make available (in print or electronically), installation and maintenance instructions for the product being put to use.

B. Specifier Responsibilities

1. It is the responsibility of the **Specifier** to ensure that all jobsite conditions are capable of meeting or exceeding the minimum standards and requirements of the products being specified for the project.
2. The specified wood floor must coincide with the projected interior climate capabilities of the facility receiving the wood floor. Interior climate capabilities of the facility include type and functionality of the HVAC systems, humidification/dehumidification systems, interior and exterior insulation, types of windows, and methods of construction.
3. Interior environmental conditions vary from region to region and jobsite to jobsite. The wood floor selection should be determined by the interior climate capabilities of the facility receiving the wood flooring. The floor selection determination may include species, cut, width, installation method, manufacturer requirements, or whether to use solid or engineered flooring for each unique situation.

C. Supplier/Seller Responsibilities

1. It is the responsibility of the **Supplier** and/or the **Seller** to ensure all products being supplied meet or exceed the minimum federal and local regulations where it is being sold.
2. Product should be stored in dry, climate-controlled, and well-ventilated facilities that meet the minimum requirements of the products being stored and sold.
3. Products should not be sold to, or delivered to, a jobsite that does not meet manufacturer minimum requirements, or the minimum requirements detailed in the Jobsite Conditions chapter of this publication.
4. Expired/outdated product should not be sold without clear acknowledgment by the buyer.

D. Builder Responsibilities

1. If the wood floor installation is part of the scope of the construction project, it is the responsibility of the **Builder** to ensure that all wet work (e.g., drywall taping, painting, texturing, tile work, etc.) is completed and thoroughly dry prior to wood flooring installation.
2. Building codes establish minimum standards and not always best practices. The **Builder** must be aware of the materials specified within the home in order to build accordingly. Any additional building costs must be accounted for during the specification and planning phases of construction.
3. In new construction, it is the responsibility of the **Builder** and/or the **Specifier** to ensure the facility being built is designed and capable of sustaining an environment conducive to the building materials being used in it. The jobsite must meet or exceed all wood flooring manufacturer requirements and NWFA Guidelines prior to wood flooring delivery and installation.
4. It is the responsibility of the **Builder** to ensure moisture control policies have been put in place and implemented to protect all building components, including, but not limited to, wood flooring, prior to, and during, the entire construction process. Some porous materials (e.g., gypsum, plywood, and oriented strand board) can tolerate short-term wetting, but they must be dry before wood flooring installation (according to the US Environmental Protection Agency).
5. In water restoration projects, it is the responsibility of the **Builder** and/or the restoration company to meet the minimum moisture requirements as outlined in these Guidelines.

E. Installer Responsibilities

1. It is the responsibility of the **Installer** to recheck the jobsite conditions at the time of installation and to confirm that they meet or exceed the wood flooring manufacturer's requirements.
2. It is the responsibility of the **Installer**, and/or the **Buyer** and/or the **End-User** to ensure that the wood flooring product meets their expectations for visual appearance and manufacturing quality prior to installation. Prior to commencing installation, the **Seller, Installer, Buyer, and End-User** should, when possible, loose-lay several boards on the floor in the room where they will be installed. If the visual appearance, color, sheen, or manufacturing quality of the product is deemed unacceptable, it should not be installed.
3. Installation of flooring constitutes acceptance of the material and the site conditions at the time of installation.

F. End-User Responsibilities

1. It is the responsibility of the **End-User** to use the flooring product as it is intended to be used.
2. Post-installation, it is the responsibility of the **End-User** to maintain temperature and humidity levels year-round, as required by the flooring manufacturer.
3. It is the responsibility of the **End-User** to follow a maintenance routine and use the proper maintenance products as required by the flooring and finish manufacturers.

JOBSITE CONDITIONS

The jobsite should meet, or exceed, all manufacturer requirements and NWFA Guidelines prior to wood delivery and before, during, and post installation.

PART I

Exterior Climate Considerations

- A. **Regional Climate Variations:** The average outdoor temperature and humidity varies from region to region. Across every region, wood floors can successfully be installed; however, all wood floors cannot be installed in the same manner in all climate regions. The regional variability of the exterior climate will affect the indoor conditions of the space.
- B. **The climate zone map** has been adopted by many organizations including the U.S. Department of Energy (US DOE), the International Energy Conservation Code (IECC), the International Code Council (ICC), and the American Society of Heating, Refrigerating and Air Conditioning Engineers

(ASHRAE). The Climate Zone designations in the map are specifically used to determine details about different methods of construction based on the climate in which the building is being constructed. (Refer to the Regional Climate Variations publication for more detailed information.)

- C. As the wood flooring professional, you should have a general understanding of the geographic climate zone for the location of the building that is receiving the wood floor. Use the climate zone maps, the MC maps, and the experience and understanding you have of your region, to determine the seasonal ranges (high MC and low MC) in the area in which the floors are being installed. This information will allow you to determine whether the interior conditions of the space can accommodate the flooring being installed, and to determine best installation practices.

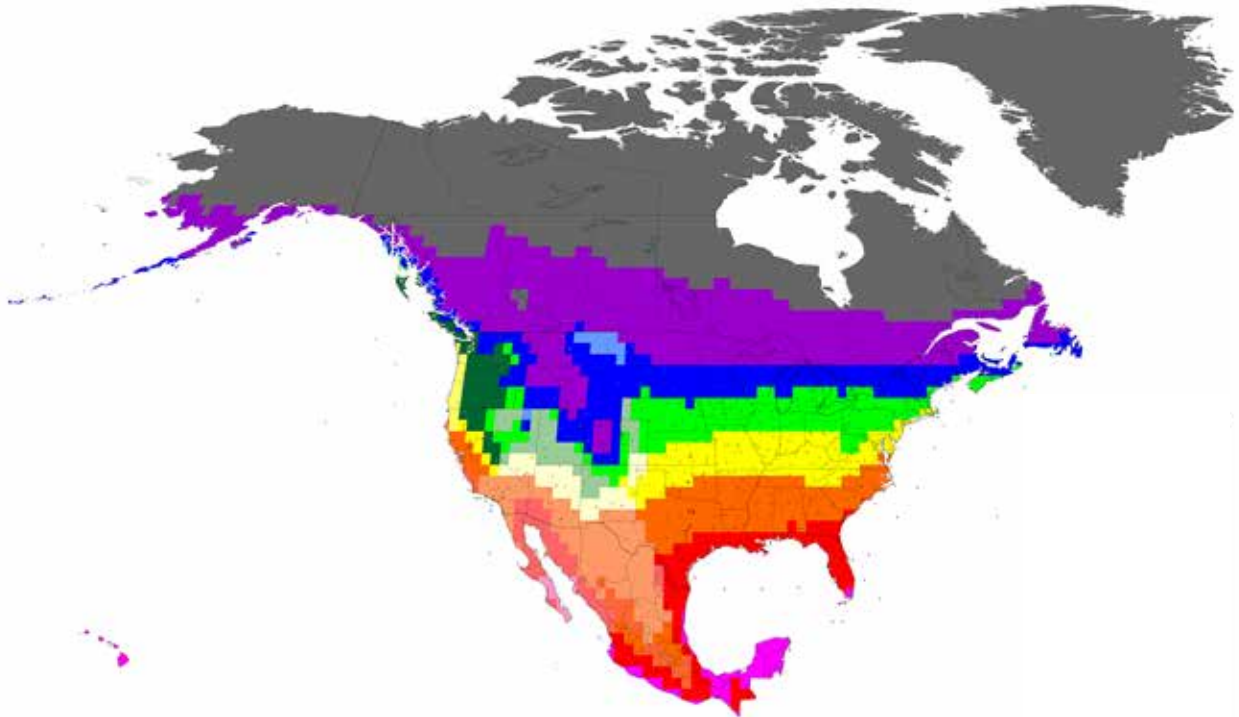

PART II Exterior Conditions of the Building

Check the exterior of the structure to ensure the jobsite is ready to receive wood floors. Walk around the structure to identify any potential concerns that may affect your wood floor installation. Document, take photographs, and address all concerns with the homeowner and/or builder.



A. Grade

1. **Grade Level:** Note the grade level where the flooring is to be installed to ensure the flooring selected is appropriate.
 - a. **Above-grade** is defined as any portion of the subfloor where wood flooring is to be installed, that is above the plane of the surrounding ground.
 - b. **On-grade** is defined as any portion of the subfloor where wood flooring is to be installed, that is at, or above, the same plane as the surrounding ground.
 - c. **Below-grade** is defined as any portion of the subfloor where wood flooring is to be installed, that is 3" or more below ground level.
2. Engineered wood floors can be installed above-grade, on-grade, and below-grade.
3. Solid flooring can be installed on-grade and above-grade, but should not be installed below-grade unless otherwise recommended by the flooring manufacturer.

B. Site Drainage

1. Exterior surface drainage (e.g., gutters, landscaping) should direct water away from the building. Water from rain, snowmelt, nearby water sources, and irrigation systems can naturally travel toward the foundation and into the structure.
2. Lots should be graded to drain surface water away from foundation walls. Normal building code requires a minimum fall of 6" (152 mm) within the first 10 feet (3.048 m). Impervious surfaces (pavement) should be sloped a minimum of 2 percent away from the building.
3. If any obvious concerns are observed related to the exterior site drainage, they should be addressed by a qualified landscape professional prior to wood flooring delivery or installation.

PART III

Building Thermal Envelope

- A. The building thermal envelope includes the exterior walls, basement walls, floors, roof, and any other building element that encloses conditioned space.
- B. Building interiors are affected by two distinct humidity seasons - heating and cooling. Temperature and moisture (vapor) move from warmer/drier spaces to cooler/wetter spaces; this is known as vapor drive.
 1. The moisture vapor moves from the warm side of the building assembly to the cold side of the building assembly.
 2. In the summer, and in hot/humid climates, during the interior cooling season, vapor drive is predominately inward. Cooling systems lower the temperature of the interior air. Cooling the air decreases its ability to hold moisture and the interior relative humidity naturally increases. Fortunately, air conditioning cools the air by removing moisture through condensation.
 3. In the winter, during the interior heating season, vapor drive is predominately outward. Heating systems raise the temperature of the interior air. Heating the air will increase its ability to hold moisture; therefore, the interior relative humidity decreases.



- C. The flooring installer should identify where, within the building, the wood floor is being installed in relation to other adjacent unconditioned spaces.
1. Conditioned space is an area or room within the building that is intentionally heated or cooled, and humidified or dehumidified, to be maintained at the same expected conditions as the living/interior space either for the comfort of occupants, or for preserving temperature and humidity-sensitive goods.



2. Unconditioned space refers to exterior space, or a space within the shell of a building, that is uncontrolled, and is neither directly nor indirectly heated, cooled, humidified, nor dehumidified.



PART IV Interior Conditions

The conditions in the space in which the wood flooring is being installed will directly affect the performance of the wood floors. Wood flooring should not be delivered, stored, nor packages opened, on a jobsite or within any facility with uncontrolled environmental conditions, or that is outside of the conditions set forth by the manufacturer (temperature and RH) of the flooring product. Unless otherwise defined by the flooring manufacturer, follow these Guidelines as related to the interior conditions of the building at the time the wood flooring is being delivered to the jobsite.

- A. Wood flooring should be one of the last jobs completed in any remodel or new construction project.
- B. Do not deliver wood flooring to any jobsite, or install wood flooring, until the envelope of the structure is fully enclosed and protected from exterior weather conditions with all windows, doors, exterior siding, soffits, roof coverings, insulation, and ventilation in place.
- C. All exterior doors and windows must be installed and in good repair in the specific locations, and in adjacent rooms, to where wood flooring is being installed. If any issues are present, they should be repaired by a qualified professional before flooring is delivered to the jobsite or installed.
- D. Do not deliver or install wood flooring to the jobsite, until all "wet-trades" such as concrete, masonry, plastering, drywall, texturing, painting, and power washing are completed within the building thermal envelope.
- E. Verify that the facility receiving new flooring has permanent or temporary mechanical systems (heating, cooling, humidification, or dehumidification) capable of achieving and maintaining the required conditions necessary for the wood flooring being installed.
 1. These systems should be operating for a minimum of 5 days preceding delivery of flooring materials. Longer operation of HVAC systems and jobsite conditioning may be necessary prior to flooring delivery due to tighter building envelopes and wet conditions.
 2. These same conditions should be maintained prior to, during, and after wood flooring installation.
 3. Note that the use of temporary propane heating systems will introduce moisture to the environment. Large amounts of water are produced with the combustion of propane. Propane systems should be avoided prior to, during, and after wood flooring installation.



- F. Test and document the temperature and relative humidity in each of the room(s) where flooring is being installed.
 1. For factory-finished solid and engineered wood flooring, always follow the manufacturer's requirements for interior temperature and relative humidity requirements.
 2. As a general rule for solid wood flooring, with geographic exceptions, appropriate temperature and humidity conditions are defined as those conditions where the interior environment is controlled to stay within a relative humidity range between 30% to 50% and a temperature range between 60-80 degrees Fahrenheit. These ranges are likely to be the average of all types of wood products used in normal household environments, assuming common heating and cooling equipment is used to ensure human comfort.
 3. Some manufacturers intentionally produce flooring products at higher (8-13%) or lower (4-9%) moisture content levels to accommodate different geographical regions. In some climates, the ideal average humidity range can be higher (45% to 65%) or lower (20% to 40%). Know your region and the flooring product specified for the project to determine whether they are properly aligned before selling and delivering material to the jobsite.
- G. Ensure the substrate receiving the wood floor meets all minimum standards detailed in the applicable Substrates chapter.
- H. The space below the flooring system should be free of any evidence of standing water and high humidity levels.
- I. **IMPORTANT:** Never install a wood floor over a known moisture condition. A known moisture condition is one that you are aware of, and could pose future damage to the flooring, the building, or the occupants. It is compulsory practice to always test for moisture regardless of conditions so that any unknown conditions can become known conditions that then can be handled appropriately. In all cases, it is important that the installer consult with all involved parties including the manufacturer and customer.
- J. Where the minimum jobsite conditions are present, the flooring may be delivered to the rooms in which it will be installed.

ACCLIMATION/CONDITIONING

The process of aligning the wood flooring and the environment it is to be installed in is defined as acclimation, or more accurately, conditioning. This process involves understanding that the wood flooring and the facility are compatible. Unless otherwise directed by the flooring manufacturer, the following guidelines should be followed for acclimation/conditioning of each type of wood flooring.

The values on the accompanying map provide examples of how average moisture contents (MC) for interior use of wood products vary from one region to another, and from one season to another within a region.

The United States Department of Agriculture (USDA) Forest Products Laboratory suggests the following MC average and ranges for interior wood products:

- Most areas of the United States: average = 8% MC, ranging from 6-10% MC
- Dry southwestern regions: average = 6% MC, ranging from 4-9% MC
- Damp, warm coastal areas: average = 11% MC, ranging from 8-13% MC

Actual interior MC conditions in any location may differ significantly from these numbers.

MOISTURE MAP OF NORTH AMERICA

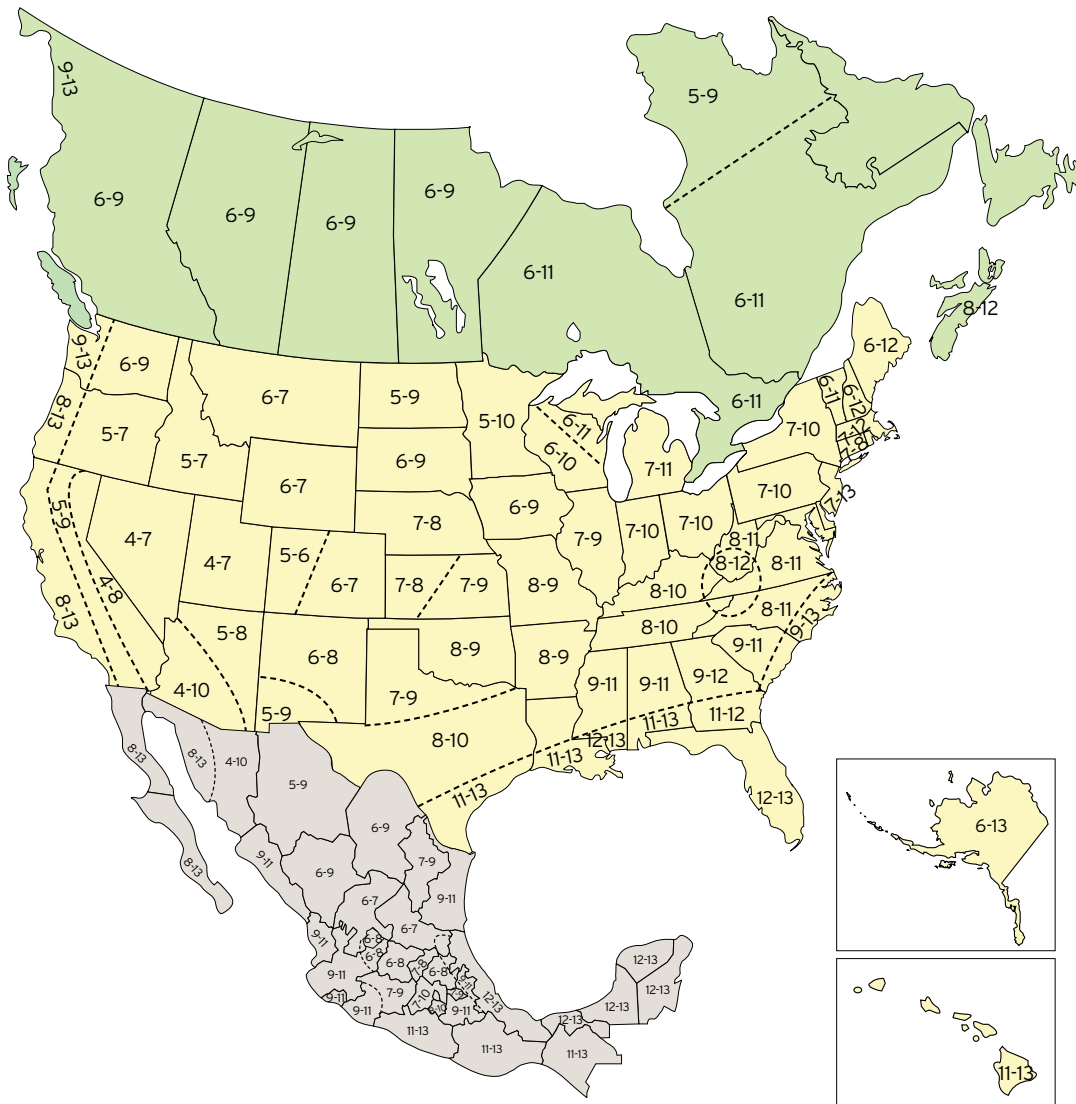

PART I
Solid Wood Flooring

- A. Prior to delivery of the wood flooring, check and record the jobsite ambient conditions and the subfloor moisture to ensure they coincide with the wood flooring requirements that have been selected.
- B. Upon delivery of the flooring to the jobsite, recheck and record the temperature and relative humidity in the space receiving the wood floor. The temperature and humidity must be within the manufacturer's requirements.
- C. Upon delivery of the flooring to the jobsite, recheck and record the MC of multiple boards of flooring from a variety of bundles. Check with your moisture meter manufacturer to determine the correct setting on your meter for the wood species being tested.
 - 1. Take MC readings of the wood flooring on a minimum of 40 boards for up to the first 1,000 square feet, and an additional 4 readings per 100 square feet thereafter, and average the results. With pin-type moisture meters, tests should be taken on the back of the boards to avoid damage to the face of the flooring. In general, more readings will result in a more-accurate average. Record, date, photograph, and document all results.
 - 2. The readings should coincide with the required temperature and humidity in the facility receiving wood flooring. The table on the opposite page indicates the predicted equilibrium moisture content of wood at any given combination of temperature and relative humidity.
 - 3. Any unusually high or low moisture readings should be isolated and not installed in the floor.
- D. Upon delivery of the flooring to the jobsite, recheck and record the MC of the subfloor. Check with your moisture meter manufacturer to determine the correct setting on your meter for the wood subfloor being tested.

- 1. After calibrating your meter to the subfloor material being tested, take MC readings in a minimum of 20 test locations for up to the first 1,000 square feet, and an additional 4 readings per 100 square feet thereafter, and average the results. Testing locations should be representative of the entire project and include a minimum of three tests per room receiving wood. Pay special attention to exterior walls and plumbing. Elevated readings should be addressed prior to delivery and installation of any wood flooring. In general, more readings will result in a more-accurate average. Record, date, photograph, and document all results.
- 2. The average of the wood subfloor readings should coincide with the manufacturer-required temperature and humidity levels in the facility receiving wood flooring. Where the wood subfloor MC is not aligned with the required conditions in the facility receiving wood, the general rule of thumb is to ensure the MC of the wood subfloor is no more than 4% greater than the MC of solid strip (<3" widths) wood flooring, and no more than 2% greater than the MC of solid plank (≥3" widths) wood flooring being installed.
- 3. Concrete subfloors must be moisture tested, and adequate moisture control systems should be in place prior to installation of any solid wood floor.
- 4. Any unusually high or low subfloor moisture readings should be isolated and addressed prior to wood floor installation.
- E. When the wood flooring is delivered at a MC that coincides with the expected in-use (e.g., normal living) and manufacturer's required ambient conditions within the facility, and this coincides with the subfloor moisture conditions, and these conditions are being maintained, the flooring may be installed immediately.

MOISTURE CONTENT OF WOOD		AT VARIOUS TEMPERATURE AND RELATIVE HUMIDITY READINGS																		
°F	°C																			
30	-1.1	1.4	2.6	3.7	4.6	5.5	6.3	7.1	7.9	8.7	9.5	10.4	11.3	12.4	13.5	14.9	16.5	18.5	21.0	24.3
40	4.4	1.4	2.6	3.7	4.6	5.5	6.3	7.1	7.9	8.7	9.5	10.4	11.3	12.4	13.5	14.9	16.5	18.5	21.0	24.3
50	10	1.4	2.6	3.7	4.6	5.5	6.3	7.1	7.9	8.7	9.5	10.4	11.3	12.4	13.5	14.9	16.5	18.5	21.0	24.3
60	15.6	1.3	2.5	3.6	4.6	5.4	6.2	7.0	7.8	8.6	9.4	10.2	11.1	12.1	13.3	14.6	16.2	18.2	20.7	24.1
70	21.1	1.3	2.5	3.5	4.5	5.4	6.2	6.9	7.7	8.5	9.2	10.1	11.0	12.0	13.1	14.4	16.0	17.9	20.5	23.9
80	26.7	1.3	2.4	3.5	4.4	5.3	6.1	6.8	7.6	8.3	9.1	9.9	10.8	11.7	12.9	14.2	15.7	17.7	20.2	23.6
90	32.2	1.2	2.3	3.4	4.3	5.1	5.9	6.7	7.4	8.1	8.9	9.7	10.5	11.5	12.6	13.9	15.4	17.3	19.8	23.3
100	37.8	1.2	2.3	3.3	4.2	5.0	5.8	6.5	7.2	7.9	8.7	9.5	10.3	11.2	12.3	13.6	15.1	17.0	19.5	22.9
120	48.9	1.1	2.1	3.0	3.9	4.7	5.4	6.1	6.8	7.5	8.2	8.9	9.7	10.6	11.7	12.9	14.4	16.2	18.6	22.0
140	60	0.9	1.9	2.8	3.6	4.3	5.0	5.7	6.3	7.0	7.7	8.4	9.1	10.0	11.0	12.1	13.6	15.3	17.7	21.0
160	71.1	0.8	1.6	2.4	3.2	3.9	4.6	5.2	5.8	6.4	7.1	7.8	8.5	9.3	10.3	11.4	12.7	14.4	16.7	19.9
		5	10	15	20	25	30	35	40	45	50	55	60	65	70	75	80	85	90	95
		Relative Humidity (percent)																		

F. Adjusting the MC of the solid wood flooring may be necessary under either of the following circumstances: 1 - When the MC of the wood flooring product is different from the expected in-use conditions of the facility, or 2 - In extreme environments.

1. CAUTION: Altering the MC of any wood product, in order to accommodate extreme conditions, involves introducing or removing moisture from the wood prior to installation. When doing so, the change in moisture may cause the floor boards to shrink or swell outside of the manufactured dimension. Solid wood generally will not take-on or give-up moisture, nor will it change dimension, uniformly. This may adversely affect the installation, and should be taken into account when bidding the project and installing the flooring.



2. Conditioning of solid wood in these environments can be facilitated by separating the flooring into small lots and/or completely opening the packaging. Then cross stack the materials with spacers (3/4" to 1" stickers) between each layer of flooring to allow air circulation on all sides of all boards until EMC has been reached.
 3. Off-site conditioning of the flooring material in a controlled environment is possible when the off-site conditions reflect the flooring manufacturer's requirements and the expected in-use (normal living) conditions.
 4. Imported/tropical species often require two to three times longer equilibrating to their surroundings than most domestic species due to higher overall density, oil, and resin content, and their interlocking cell structure. Take this additional time into account when scheduling the project.
- G. With unfinished solid wood flooring, after installation and before sanding and finishing takes place, and when scheduling allows, allow the flooring to stabilize in its new environment for 5-7 days. Flooring installed using an adhesive application system may require a longer post-installation conditioning period to allow all residual off gassing to occur prior to application of a finish. Follow the adhesive manufacturer's recommendations for dry times and off-gassing prior to sanding and finishing.

PART II Engineered Wood Flooring

- A. Prior to delivery of the wood flooring, check and record the jobsite ambient conditions and the subfloor moisture to ensure they coincide with the wood flooring requirements that have been selected.
- B. Upon delivery of the flooring to the jobsite, recheck and record the temperature and relative humidity in the space receiving the wood floor. The temperature and humidity must be within the manufacturer's requirements.
- C. Upon delivery of the flooring to the jobsite, recheck and record the MC of the subfloor. Check with your moisture meter manufacturer to determine the correct setting on your meter for the wood subfloor being tested.
 1. Take MC readings of the wood subflooring at a minimum of 20 test locations per 1,000 square feet, and an additional 4 readings per 100 square feet thereafter, and average the results. In general, more readings will result in a more-accurate average. Any unusually high or low moisture readings should be isolated and addressed individually. Record, date, photograph, and document all results.
 2. The average of the wood subfloor readings should coincide with the manufacturer-required temperature and humidity levels in the facility receiving wood flooring. (Refer to the MC chart in Part I of this chapter.)
 3. Concrete subfloors must be moisture tested, and adequate moisture control systems should be in place prior to installation of any wood floor.
 4. Any unusually high or low subfloor moisture readings should be isolated and addressed prior to wood floor installation.
- D. Follow the flooring manufacturer's moisture testing, acclimation, installation, and maintenance instructions to retain all warranty coverage.
- E. When the wood flooring is to the expected in-use (e.g., normal living) and manufacturer's required ambient conditions within the facility, and this coincides with the subfloor moisture conditions, and these conditions are being maintained, the flooring may be installed immediately.
- F. With unfinished engineered wood flooring, after installation and before sanding and finishing takes place, and when scheduling allows, let the flooring stabilize in its new environment for a period of time. Flooring installed using an adhesive application system may require a longer post-installation conditioning period to allow all residual off-gassing to occur prior to application of a finish. Follow the adhesive manufacturer's recommendations for dry times and off-gassing.

PART III Parquet and End-Grain Wood Flooring

- A. Prior to delivery of the wood flooring, check and record the jobsite ambient conditions and the subfloor moisture to ensure they coincide with the wood flooring requirements that have been selected.
- B. Upon delivery of the flooring to the jobsite, recheck and record the temperature and relative humidity in the space receiving the wood floor. The temperature and humidity must be within the manufacturer's requirements.
- C. Upon delivery of the flooring to the jobsite, recheck and record the MC of multiple panels or blocks from a variety of packages. Check with your moisture meter manufacturer to determine the correct setting on your meter for the wood species being tested.
 1. For parquet or end-grain flooring, take MC readings on a minimum of 40 panels/blocks per 1,000 square feet, and an additional 4 readings per 100 square feet thereafter, and average the results. With pin-type moisture meters, tests should be taken on the back of the wood to avoid damage to the face of the flooring. In general, more readings will result in a more-accurate average. Record, date, photograph, and document all results.
 2. The readings should coincide with the required temperature and humidity in the facility receiving wood flooring.
 3. Any unusually high or low moisture readings should be isolated and not installed in the floor.
- D. Upon delivery of the flooring to the jobsite, recheck and record the MC of the subfloor. Check with your moisture meter manufacturer to determine the correct setting on your meter for the wood subfloor being tested.
 1. Take MC readings of the wood subflooring at a minimum of 20 test locations per 1,000 square feet, and an additional 4 readings per 100 square feet thereafter, and average the results. In general, more readings will result in a more-accurate average. Any unusually high or low moisture readings should be isolated and addressed individually. Record, date, photograph, and document all results.
 2. The average of the wood subfloor readings should coincide with the manufacturer required temperature and humidity levels in the facility receiving wood flooring. Where the wood subfloor MC is not aligned with the required conditions in the facility receiving wood, the general rule of thumb is to ensure the MC of the wood subfloor is no more than 4% greater than the MC of parquet wood

- flooring, and no more than 2% greater than the MC of end-grain wood flooring being installed.
3. Concrete subfloors must be moisture tested, and adequate moisture control systems should be in place prior to installation of any solid wood floor.
 4. Any unusually high or low subfloor moisture readings should be isolated and addressed prior to wood floor installation.
- E. When the wood flooring is delivered at a MC that coincides with the expected in-use (e.g., normal living) and manufacturer's required ambient conditions within the facility, and this coincides with the subfloor moisture conditions, and these conditions are being maintained, the flooring may be installed immediately.
- F. In cases where the MC of parquet or end-grain flooring is outside of the range of the expected in-use (e.g., normal living) conditions, or in extreme environments, conditioning of the flooring may be necessary.
1. Altering the MC of the flooring, in order to accommodate extreme conditions, involves introducing moisture or removing moisture from the flooring prior to installation. When doing so, the change in moisture may cause the material to shrink or swell outside of the manufactured dimension. This may adversely affect the installation, and should be taken into account when bidding the project and installing the flooring.



2. Due to the orientation of the grain, end-grain flooring tends to equilibrate at a relatively fast rate (depending on thickness and species) as compared to other solid sawn

boards. Conditioning end-grain flooring can be facilitated by separating the individual blocks into small lots and then restacking them, on-edge, in the expected in-use (e.g., normal living) conditions of the facility. The lower and more spread out the blocks are laid out, the faster the conditioning process will take.

3. Imported/tropical species often require two to three times longer equilibrating to their surroundings due to higher overall density, oil and resin content, and their interlocking cell structure. Take this additional time into account when scheduling the project.
 4. Off-site conditioning of the flooring material in a controlled environment is possible when the off-site conditions reflect the expected in-use (normal living) conditions.
- G. After installation, and before sanding and finishing takes place, allow the flooring to stabilize in its new environment for 5-7 days, when scheduling allows. Flooring installed using an adhesive application system may require a longer post-installation conditioning period to allow all residual off-gassing to occur prior to application of a finish. Follow the adhesive manufacturer's recommendations for dry times and off-gassing.

PART IV Reclaimed Wood Flooring

- A. Reclaimed lumber that has been milled into solid wood flooring must be dried to a MC that coincides with the home and the environment in which it is being installed.
- B. Prior to delivery of the wood flooring, check and record the jobsite ambient conditions and the subfloor moisture to ensure they coincide with the wood flooring requirements.
- C. Upon delivery of the flooring to the jobsite, recheck and record the temperature and relative humidity in the space receiving the wood floor. The temperature and humidity must be within the manufacturer's requirements and the requirements that the facility can sustain year-round.
- D. Upon delivery of the flooring to the jobsite, recheck and record the MC of multiple boards of flooring from a variety of bundles. Check with your moisture meter manufacturer to determine the correct setting on your meter for the wood species being tested.
- E. Any reclaimed wood flooring should be acclimated the same as detailed in the applicable wood flooring section (e.g., reclaimed solid, reclaimed engineered, reclaimed parquet, or reclaimed end-grain).

MOISTURE TESTING

The determination of moisture content is an essential part of quality control within the flooring installation process. Flooring installers must know the ambient conditions in the space, the moisture content of the wood flooring, and the moisture content of the substrate. Hand-held thermo-hygrometers and electronic moisture meters should be a critical part of every flooring contractor's toolbox. Moisture content (MC) from 5-30% may be determined using various moisture meters developed for this purpose.



PART I Temperature/Relative Humidity

The moisture content in wood is directly affected by temperature and humidity.

- A. In order to understand why temperature and humidity affect wood, it is important to understand the relationship between temperature and humidity.
 1. Temperature is simply a measurement that indicates how hot or cold something is. In the United States we use the Fahrenheit (°F) scale. The majority of the rest of the world uses the Celsius (°C) scale.
 2. Humidity is the amount of water vapor in the air. This air/water vapor mixture, when measured as the actual moisture in a given volume of air (or grains/ft³) is the absolute humidity (H_{absolute}). In regular usage, however, we use the term relative humidity (RH), which is the ratio of the amount of moisture the air is holding in comparison to the total amount of moisture the air can hold at the same temperature. No matter how the property of humidity is expressed, the values are very much temperature dependent.
 3. Heating the air will increase its ability to hold moisture; therefore, for the same physical amount of water, the relative humidity decreases (absolute humidity remains the same).

4. Cooling the air will decrease its ability to hold moisture; therefore, for the same physical amount of water, the relative humidity increases (absolute humidity remains the same).
5. Humidity is important because wood products exchange water molecules from the surrounding air based upon the amount of moisture in the air.

B. Test the temperature and relative humidity in the room(s) where the flooring is being installed.

C. **Hygrometers:** Instruments used for measuring the amount of water vapor in the air. There are a few types of these instruments, but in modern times, we

employ digital thermo-hygrometers. These tools typically can read temperature, relative humidity, and



oftentimes properties like absolute humidity and dew point as well. Many of today's thermo-hygrometers are wireless, have data logging, and even have remote capabilities.

D. **Data Loggers:** An electronic device that records and stores data over time or in relation to location, either with a built-in instrument or sensor or via external instruments and sensors. These instruments are oftentimes left on the jobsite in order to monitor the conditions in the space prior to, during, and after wood flooring installation.

E. The "EMC of Wood at Various Temperature and Relative Humidity Readings" table in the Acclimation/Conditioning chapter, provided by USDA Forest Products Lab, indicates a reasonable representation of the predicted Moisture Content (MC) of wood at any given combination of temperature and relative humidity. Use the values in this table to approximate the average MC of the wood based on the temperature and humidity readings in the facility. You also can use this chart to determine approximate change in moisture content based on a seasonal change in conditions within the facility.

PART II Moisture Testing Wood

A. Oven Dry Method (Laboratory Test)

1. The moisture content (MC) of wood is measured as the weight of the water in the wood expressed as a percentage of the weight of the wood itself. The weight of the wood itself is obtained when the wood is dried to a point where all of the moisture is removed. This is referred to as oven-dried. Weight, shrinkage, strength, and other properties depend in part on the moisture content of wood.
2. Standard Test Methods for Direct Moisture Content Measurement of Wood and Wood-Based Materials (Oven Dry Method - ASTM D4442):
 - a. This method is generally accepted for basic laboratory work and as a standard for calibrating other test methods. This is because the oven-dry test method is the most precise test method to determine gravimetric moisture content.
 - b. This test method requires weighing the piece of wood with moisture, removing the moisture by fully drying it in an oven (215°F-220°F or 102°C-105°C) and then reweighing. The equation for determining moisture content is as follows:

$$\frac{(\text{weight of wood with water} - \text{oven-dry weight of wood})}{\text{oven-dry weight of wood}} \times 100 = \text{MC (\%)}$$

- B. **Moisture Meters:** There are two main types of meters: pinless meters (dielectric) and pin-type meters (electrical resistance). Both types of meters will give generally reliable readings from as low as 5% MC, up to the fiber saturation point (FSP) of the species being tested.

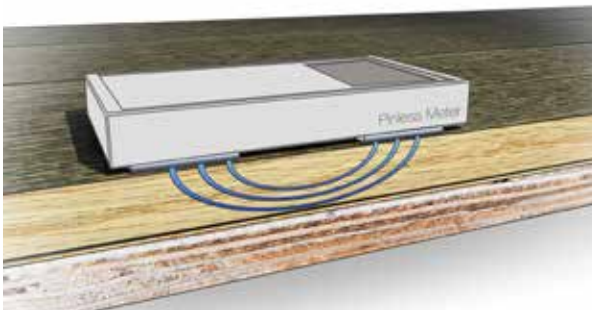

1. Pinless Meters

- a. The pinless, dielectric types are also referred to as non-invasive, non-destructive, scanning, or surface meters.

- b. Signal penetration for these types of meters can be from ¼" up to 1 ½".
- c. These meter readings are dependent on material density and specific gravity.
- d. The meter can be moved across the surface to test multiple areas for moisture in a wood block or plank.
- e. Some of these types of meters can be sensitive to surface moisture, but relatively unaffected by temperature (check with the meter manufacturer).
- f. Measurements can also be taken through coatings without damage to the surface. However, some coatings with metallic components may affect the accuracy of the readings.

2. Pin-Type Meters

- a. The pin-type meters measure the electrical resistance across opposing sets of pins, which are pushed into the wood.
- b. Placement of the pins in relation to grain orientation is manufacturer and meter specific. This depends on the international standard to which the meter is calibrated. Check with your meter manufacturer for proper use.
- c. These types of meters force an electrical current through the wood sample between the probes. Because wood is a poor conductor of electricity and water is a good conductor of electricity, wood with higher MC has a lower resistance. The results are displayed as a number that represents a moisture content percentage.
- d. Pin-type meters are available with either insulated or non-insulated pins:

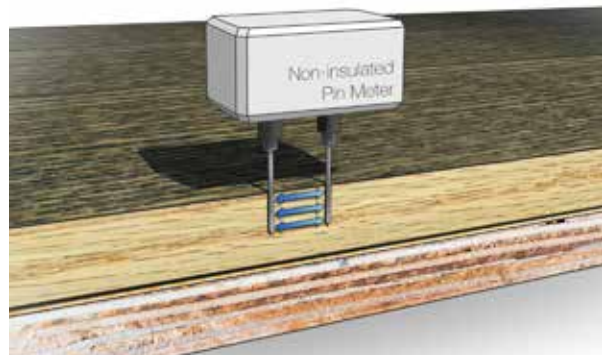

- i. Non-insulated pins will read as deep as they are inserted and will report the highest value of resistance through the entire depth of the pins.

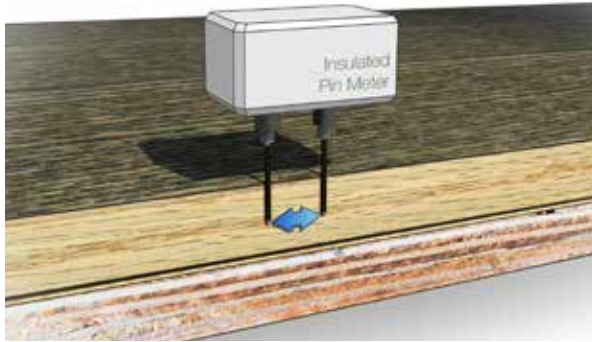

ii. Insulated pins are typically available in many different lengths, from 1"-3", and are normally used with a slide hammer extension. Insulated pins only measure the resistance at the uninsulated tips of the pins, allowing one to evaluate the moisture gradients through the sample of flooring, subflooring, or the entire flooring system.

C. Moisture Meter Reading Variables

1. Species Correction

- a. Most meter manufacturers calibrate their meters to pine/Douglas fir/hemlock.
- b. Species correction is a meter manufacturer-specified, user-adjusted setting that is made to the moisture meter to compensate for either varying electrical properties (for pin-type meters) or densities (for pinless meters) of the species under test, as compared to the species of the reference calibration.
- c. Some meters have a species correction adjustment built in, while others include conversion charts to account for species correction.
- d. Making these adjustments allows for a more-accurate assessment of the moisture within the wood being tested.

2. Calibration

- a. Calibration ensures the meter is giving accurate readings.
- b. Calibration is usually considered the responsibility of the manufacturer, and the user accepts the calibration data supplied with the meter. The accuracy of calibration, especially in regard to sampling and specimen control, is usually unknown to the user.
- c. ASTM D4444 is the standard test method for laboratory standardization and calibration of handheld moisture meters.
- d. Some meters can be checked for calibration internally or by use of a calibration block supplied by the manufacturer.
- e. Check with the meter manufacturer to determine if, when, and how to get your

meter properly calibrated. Many meter manufacturers will provide a calibration certificate, which verifies National Institute of Standards and Technology (NIST) traceability and that the meter is operating properly.

3. Meter Drift

- a. Meter drift is the decrease (or increase) in true moisture content over a specified elapsed time.
- b. Record readings from your meter within the first 2-3 seconds to ensure accuracy.

4. Temperature Correction

- a. The temperature of the wood will significantly influence the readings of a pin-type meter.
- b. Temperature correction is the adjustment that is made to the moisture meter reading to compensate for the phenomena that the electric conductance of wood increases as the temperature increases, and vice-versa. This adjustment, whether manual or automatic, allows for accurate measurements of moisture content even at extreme temperatures (e.g., less than 50°F and greater than 90°F).
- c. Use the following chart to determine the temperature correction based on the surface temperature of the wood being tested.

TEMPERATURE CORRECTION												
SURFACE TEMPERATURE		METER READINGS										
°F	°C	6	7	10	15	20	25	30	35	40	50	60
0	-17.8	9	11	15	22	31	38	45	53			
20	-6.7	8	10	14	20	28	34	40	47	55		
40	4.4	7	8	12	18	24	30	36	42	48		
60	15.6	6	7	11	16	21	27	32	38	43	54	
80	26.7	6	7	9	14	19	23	28	33	38	47	55
100	37.8	5	6	8	12	17	21	25	29	34	42	50
120	48.9	5	5	7	11	15	19	22	26	30	38	44
140	60	4	5	7	10	14	17	20	23	27	34	40
160	71.1	4	4	6	9	12	15	18	21	24	30	36

Moisture content values above the fiber saturation point are only qualitative. The temperature correction values shown in this chart have been rounded for easy reference.

- 5. The materials within the **depth of signal penetration** can influence the readings the meter is taking. Substrate composition, adhesives, and engineered flooring core and backing components (different species or composite materials) all can have different densities, specific gravities (pinless), or electrical resistances (pin-type), which will alter the end reading. For example, a ¾" deep scan over a ½" engineered floor is also scanning the core, the flooring adhesive, and the surface of the substrate. Check with the meter manufacturer for testing protocol, accuracy, and appropriate species correction values when testing any engineered wood flooring product.

6. **Skill of the Operator:** Although moisture meters are normally very simple to operate, there are many user-errors that can affect the accuracy and reliability of the readings.
 - a. Are the batteries in the meter fresh? A weak battery can affect the readings the meter is giving you.
 - b. Follow all of the meter manufacturer instructions on proper use of the tool.
 - c. Wood flooring material selection should be taken into account to achieve the real objectives of the moisture measurements.

PART III

Moisture Testing Wood Subfloors

At the time of installation, it is important to know the moisture content of not only the wood flooring, but of the substrate as well.



- A. Due to the variability in wood subflooring materials, such as the different species of woods used in the production of wood subfloors, and the non-wood resins and adhesives used within them, it is difficult to get an accurate moisture reading of this material. Check with the moisture meter manufacturer for proper settings, testing methods, and correction values when testing wood subfloor materials.
- B. When in doubt, check the moisture content of other properly conditioned wood materials (2x4s, newel posts, wood beams, etc.) within the structure in order to get an idea of where the EMC is in comparison to where it should be, and then compare this value with the EMC chart as a baseline for testing the subfloor.
- C. After calibrating your meter to the subfloor material being tested, take MC readings in a minimum of 20 test locations for up to the first 1,000 square feet, and an additional 4 readings per 100 square feet thereafter, and

- average the results. Testing locations should be representative of the entire project and include a minimum of three tests per room receiving wood. Pay special attention to exterior walls and plumbing. Elevated readings should be addressed prior to delivery and installation of any wood flooring. In general, more readings will result in a more-accurate average. Record, date, photograph, and document all results.
- D. The MC of the subfloor should coincide with the expected in-use (e.g., normal living) conditions of the facility, based on the EMC chart. Anything outside of this range would be considered unusually high.
- E. In hot and humid climates, and during the humid season, the subflooring should not exceed 13% moisture content (MC). In regions where equilibrium moisture content (EMC) within the facility can sustain these higher MC levels, additional precautions should be implemented through the flooring product selection and the acclimation/conditioning process (see Acclimation/Conditioning chapter for more information).
- F. Any unusually high MC readings must be identified, documented, and addressed in order to establish the size and magnitude of the problem area. Installation should not proceed until the origin of the moisture has been identified and remedied.
 1. **IMPORTANT:** Never install a wood floor over a known moisture condition. A known moisture condition is one that you are aware of, and could pose future damage to the flooring, the building, or the occupants. It is compulsory practice to always test for moisture regardless of conditions so that any unknown conditions can become known conditions, which then can be handled appropriately.
 2. The traditional standard for protecting wood and wood products from rot or decay is to keep the moisture content below 19 percent. Studies have shown, however, that mold growth can occur on wood at moisture content levels above 15 percent, and corrosion of metal fasteners can occur when moisture content exceeds 18 percent. Reaching these moisture content levels does not mean rot, decay, mold growth, or corrosion will occur, but does raise a potential concern. In all cases, it is important that the installer consult with all involved parties including the manufacturer and customer.
- G. Another key variable of the moisture content of wood subfloors involves what is going on below the subfloor.
 1. When the space below the subfloor is controlled and conditioned to the same temperature and RH as above the floor, the moisture content through the thickness of the subfloor material should be the same.

2. When conditions below the subfloor are unconditioned, the moisture content will vary through the thickness of the subfloor system. This difference may affect the installed wood flooring and can result in damage.
3. Do not install a wood floor over an unconditioned space without addressing the moisture situation as detailed in the Underlayments: Moisture Control chapter.

PART IV Moisture Testing Concrete Subfloors

It is extremely important to test for moisture on every flooring job. Even when the adhesive manufacturer states "no moisture testing is required," it is still in your best interest to moisture test, and document the results. Doing so will minimize the risk of failure, it will meet the flooring manufacturer's warranty requirements, it will fulfill your contractual obligation as the flooring professional, and it will minimize your liability if a failure does occur. In cases where there is not an effective vapor retarder in place directly below the slab, the results of any type of moisture test are likely to increase as moisture from the ground will enter and raise the moisture level in the concrete once it is covered.

- A. All concrete moisture tests indicate a condition of the concrete floor slab at the time of the test under the ambient conditions of the test, and may not predict future conditions of the floor slab. These tests do not indicate a permanent condition of the substrate. This is especially true if an effective moisture vapor retarder is not present or has been compromised by damage or by improper installation.
- B. Conduct tests to give you the ability to know when to start or not start a job, and to determine what products and systems will be necessary in order to install the floor. All concrete slabs, regardless of age, will exhibit changes in moisture over time.
- C. As concrete moves through its initial drying period, regular testing of moisture content to evaluate the drying condition of the slab may begin 30 days after placement.
- D. Appropriate moisture testing, specified by the flooring and/or adhesive manufacturer, is the only way to identify if moisture levels in the slab are adequate for the systems being used.
- E. All tests should be performed as dictated by the most current ASTM standard.

1. **ASTM F1869 Calcium Chloride:**

A calcium chloride moisture test is a standard test method for measuring the moisture vapor emission rate (MVER) of a concrete subfloor using anhydrous calcium chloride. The results of this test give quantifiable values.



- a. Results are shown as pounds of water over a 24-hour period, per 1,000 square feet.
- b. Ambient conditions must be 65°-85°F and 40-60% relative humidity for a minimum of 48 hours prior to conducting the test.
- c. Each prepared area must be 20"x 20," clean, and free of all foreign substances.
- d. Lightly grind the area to produce a surface profile equal to a concrete surface profile (CSP) 1-2, a minimum of 24 hours prior to testing.
- e. Weigh the calcium chloride in its container.
- f. Place the opened calcium chloride container on the prepared area and immediately cover it with a transparent cover to create an airtight seal.
- g. Let the covered container sit for 60-72 hours undisturbed.
- h. Remove the transparent cover and calculate as directed by the calcium chloride test kit manufacturer.
- i. Place three kits in the first 1,000 square feet and one per every 1,000 square feet thereafter.
- j. Record the data.
- k. Concrete slabs with a calcium chloride MVER reading of greater than 3 lbs/ 1,000 square feet/24 hour are strongly recommended to wait for further drying of the slab, or install/apply a minimum class 1 impermeable vapor retarding membrane over the slab according to the adhesive manufacturer's instructions, prior to installation.

2. **ASTM F2170**

Relative Humidity:

Relative humidity moisture testing is the standard test method for determining relative humidity in concrete floor slabs using in-situ probes. The results of this test give quantifiable values

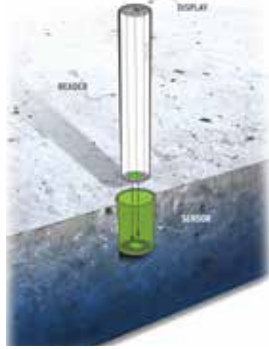

and may be used to test lightweight concrete and gypsum-based underlayments.

- a. This method predicts what the equalized relative humidity will be through the entire thickness of the slab once it is covered with flooring material.
- b. Normal living conditions should be maintained for 48 hours prior to testing.
- c. Calibration of reusable probes should be checked before every job, or if not used for 30 days.
- d. To perform the test, drill a hole in the slab at the following thickness:
 - i. If the slab is drying from top only (e.g. slab on-grade or in fluted metal decking), drill holes to 40% of the slab thickness.
 - ii. If the slab is drying from top and bottom (e.g., suspended slab), drill holes to 20% of the slab thickness.
- e. The hole diameter is determined by the manufacturer's sleeve size.
- f. Tests should be placed within 3 feet of each exterior wall.
- g. Conduct three tests for the first 1,000 square feet and one for every 1,000 square feet thereafter.
- h. Insert the sleeve, cap it, and allow it to acclimate for a minimum of 24 hours.
- i. The meter reading must not drift more than 1% relative humidity over a five-minute period. When leapfrogging reusable probes, allow at least 1 hour to achieve a true 1% drift in 5 minutes. (Leapfrogging is when reusable probes are being used. An example would be a project where you have 50 holes drilled, lined and capped. However you only own 10 probes. When those ten probes are removed from the first 10 hole liners, allowed to acclimate with the ambient conditions, and then placed in the next ten liners, it is referred to as "leapfrogging.")

- j. Record the data.
- k. Always follow manufacturer guidelines for testing procedure.
- l. Concrete slabs with a RH reading of more than 80% are strongly recommended to wait for further drying of the slab, or install/apply a class 1 impermeable vapor retarding membrane according to the adhesive manufacturer's instructions, prior to installation.

3. **ASTM F2659 Electrical Moisture Meter:**

Nondestructive electrical moisture meters are the standard guide for preliminary evaluation of the comparative moisture condition of concrete,



gypsum cement, and other floor slabs and screeds. It is a nondestructive testing method. These tests should be used to evaluate the surface of the concrete and to determine where to place other quantifiable tests. These tests provide useful information, but should not be used on their own to determine whether a floor should or should not be installed unless otherwise directed by the flooring manufacturer.

- a. To ensure accuracy, the meter should be calibrated before every project or if not used for 30 days.
- b. The interior environment of the jobsite should be 65°-85°F and 40-60% relative humidity for at least 48 hours prior to testing.
- c. The temperature of the floor slab is to be tested and reported within 8" of each test area.
- d. Eight tests should be conducted for the first 1,000 square feet and 5 additional tests should be conducted for each additional 1,000 square feet with 3-5 tests per test site. Be sure to record the highest reading. Each test area should be within a one-foot-by-one-foot area.
- e. This test shows a moisture condition in the upper one-inch of the slab.
- f. It is very useful for mapping areas for further quantitative tests.
- g. There are three types of electrical moisture meters: impedance, capacitance, and field charge detecting.

4. Other tests that are not as common, but still in use, include:

a. **ASTM D4944
Calcium
Carbide Gas
Pressure**

Test: This test method includes quantifiable test procedures for determining moisture in building and other materials.



- i. This test involves taking samples of the concrete and pulverizing them into a fine-grained material. The test material is then weighed.
- ii. This material is then placed into a testing chamber with an attached pressure gauge, along with two steel balls and a calcium carbide reagent.
- iii. The testing chamber is sealed closed, and then shaken vigorously for 2-5 minutes. This breaks up the calcium carbide that, when coming into contact with the water in the concrete, creates a highly flammable and explosive acetylene gas.
- iv. When the pressure gauge dial needle stops moving, the final pressure reading shows the percentage of water content in the dry mass of concrete.
- v. Concrete slabs with a reading of more than 2.5% requires use of a class I vapor retarder. A reading of more than 4% may not be acceptable for the wood flooring to be installed.

b. **ASTM
D4263
Plastic
Sheet**

Method:

The plastic sheet test method is used to indicate

the presence of capillary moisture in concrete. This test can provide useful information, but should NOT be used to determine whether a floor should or should not be installed.



- i. To conduct this test, tape an 18" x 18" sheet of 4 millimeter poly to clean concrete.
- ii. You should conduct one test area per 500 square feet.
- iii. Allow the test to sit for 16 hours.
- iv. After 16 hours have passed, lift the plastic.
- v. If a darkened area is visible, moisture is present.
- vi. If there is not a dark area, it does not mean moisture is not present. More conclusive tests should always be conducted.

Engineered Hardwood Flooring
Installation Instructions
Nail/ Staple, Glue, Float

CONCRETE SUB-FLOOR MOISTURE TEST

MUST BE PERFORMED AND RECORDED ONTO THE CONCRETE
PRIOR TO THE ACTUAL INSTALLATION OF FLOORING.

FAILURE TO DO SO WILL VOID THE WARRANTY.

SUB-FLOOR MOISTURE TEST RECORD

In each room of the locations specified as diagram below, please take pencil and draw box around the concrete moisture meter. Write Meter Reading and Date inside each box onto the concrete slab prior to actual installation. (4 corners; Middle of Room; In front of doors & windows; plus at least one additional reading are required)

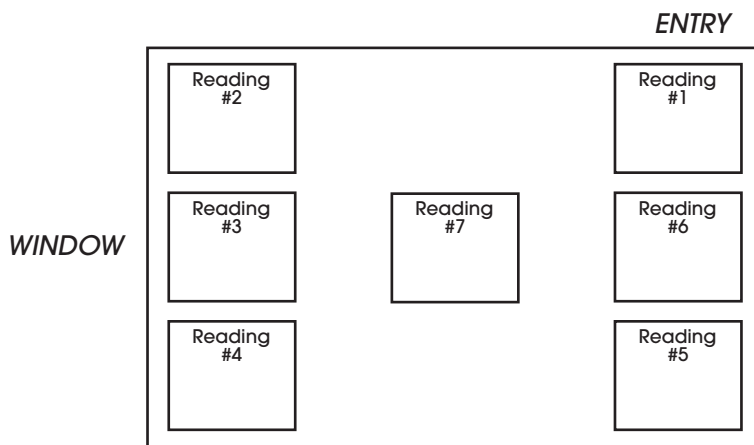

**Calcium Chloride test is recommended if area is susceptible to moisture. (Example: outside flower planter next to wall or grade with improper slope.)*

Customer Name: _____ Installer's Name/Company: _____

Address: _____ Address: _____

City: _____ St.: _____ Zip: _____ City: _____ St.: _____ Zip: _____

Phone #: _____ Fax #: _____ Phone #: _____ Fax #: _____

Product Purchased: _____ Inv. #: _____ Inv.Date: _____

Date of Test: _____ Installation Date: _____ Tested By: _____

Type of Test Performed: _____ Square Footage of Installation: _____

Was any type of sealer used on the sub-floor before installation? Yes No

If so, what type of sealer was used?: _____

Was a moisture barrier installed?: Yes No

If so, what type and thickness was used?: _____

In the event that there is a moisture-related claim filed with us, we will exam the meter readings on the slabs. Prior to installation please complete the information above. A copy should be left with the homeowner.

**Engineered Hardwood Flooring
Installation Instructions
Nail/ Staple, Glue, Float**

Record Moisture Test Results for each room below
(make additional copies if necessary):

ROOM #		
Subfloor		
Moisture Content:	_____ % Moisture Content of Subfloor	
	_____ % Moisture Content of Hardwood	
	_____ % Difference between subfloor and flooring	
Concrete Subfloor Testing		
Test Method Used:	_____ Calcium Chloride (ASTM F1869)	
	_____ RH (ASTM F2170-02) 1869	
	_____ Electronic Meter (Tramex or Equivalent)	
Type of Moisture Meter used (wood subfloor): _____		
Hardwood Flooring Moisture Readings (40 Bds Per 1,000 SF)		
1)	11)	21)
2)	12)	22)
3)	13)	23)
4)	14)	24)
5)	15)	25)
6)	16)	26)
7)	17)	27)
8)	18)	28)
9)	19)	29)
10)	20)	30)

ROOM #		
Subfloor		
Moisture Content:	_____ % Moisture Content of Subfloor	
	_____ % Moisture Content of Hardwood	
	_____ % Difference between subfloor and flooring	
Concrete Subfloor Testing		
Test Method Used:	_____ Calcium Chloride (ASTM F1869)	
	_____ RH (ASTM F2170-02) 1869	
	_____ Electronic Meter (Tramex or Equivalent)	
Type of Moisture Meter used (wood subfloor): _____		
Hardwood Flooring Moisture Readings (40 Bds Per 1,000 SF)		
1)	11)	21)
2)	12)	22)
3)	13)	23)
4)	14)	24)
5)	15)	25)
6)	16)	26)
7)	17)	27)
8)	18)	28)
9)	19)	29)
10)	20)	30)

BASEMENTS/CRAWLSPACES

PART I

Foundation Walls

Foundation issues translate to flooring issues. Cracks in foundation walls may be a larger sign of settling, structural damage, or water infiltration that will need to be fixed by a qualified contractor.

- A. Water can enter the home through these cracks, and can affect the wood subfloor above, as well as the wood flooring.
- B. These cracks may also be the result of structural issues that may affect the performance of the wood floor.
- C. Expansive soils are a type of clay or soil that is prone to large volume changes (swelling and shrinking) that are directly related to changes in soil water content. Areas with an abundance of this type of soil can exert pressure on a foundation potentially resulting in foundation, basement, or slab problems, which can translate to flooring problems.

PART II

Basements

The floor of a building that is partly or entirely below-grade. Basements are normally constructed to keep both liquid and capillary water from finding its way into the structure. This is often done by using vapor barriers on the foundation walls, surface drainage systems, below-grade drainage systems, perimeter drainage systems, and capillary breaks.

- A. The ambient conditions of the basement will change from season to season and may affect the flooring above.



- B. In a **finished basement**, the walls are normally insulated, and the space is heated and cooled similarly to the above living space. This is considered a conditioned space.



- C. In **unfinished basements**, the heating and air conditioning is often not turned on, or is maintained differently than the upstairs living spaces, in an effort to reduce wasted energy and perceived unnecessary costs. This is considered an unconditioned space. Unconditioned basements are typically cooler and have higher RH levels than the living space above.
- D. If an unfinished basement becomes finished, the conditions below the floor will change, which could affect an already installed wood floor.

PART III

Crawlspaces

The floor of the house is built over an open space that is deep enough to allow a person to gain access to the under-floor area by crawling.

- A. Structural Requirements of a Crawlpace:



1. The distance from the earth to the underside of the floor joist must be a minimum of 18" and a minimum of 12" from the earth to the underside of the beams.

2. Piers/Stilts: The pier should be set on the footing evenly.
- B. Temperature and moisture conditions in the crawlspace:
1. In general, unconditioned crawlspaces are cooler and have higher relative humidity levels than in the living space above.
 2. Humidity levels in crawlspaces are elevated by the evaporation of moisture from the soil. Evaporation generally is greatest during summer, when the soil is warmer, and less during the winter, when it is cooler. A Class I vapor retarder installed over the ground greatly reduces evaporation from crawl space floors, thereby lowering crawl space humidity levels.
 3. The temperature gradient from the cooler underside of the subfloor system in the crawlspace to the indoor living side of the subfloor system can be drastic. This temperature gradient may result in condensation forming on the underside of the subflooring due to the dew point.
- C. A crawlspace can be classified into three general categories:



1. **Open Crawlspaces:** Open pier-and-beam foundations are considered open crawl spaces. These are considered unconditioned spaces.
 - a. Open crawl spaces may have a continuous wall on just one side and be open on the other sides.
 - b. Skirting these types of crawl spaces to form an enclosed crawl space and then adding venting could result in moisture issues, especially in hot and humid areas of the country.

2. **Ventilated Crawlspaces:** The International Residential Code (IRC), section R408, contains a standard requirement for ventilation in crawlspaces.
 - a. The underfloor space between the bottom of the floor joists and the earth under any building (except space occupied by a basement) shall have ventilation openings through foundation walls or exterior walls.



- b. The minimum net area of ventilation openings shall not be less than 1 square foot (0.0929 square meters) for each 150 square feet (14 square meters) of under-floor space area, unless the ground surface is covered by a Class I vapor retarder material.



- c. Where a Class I vapor retarder material is used, the minimum net area of ventilation openings shall not be less than 1 square foot (0.0929 square meters) for each 1,500 square feet (140 square meters) of under-floor space area.
- d. One such ventilating opening shall be within 3 feet (914 mm) of each corner of the building.



3. **Enclosed and Conditioned Crawlspaces:** Crawl spaces are considered enclosed and conditioned where they meet all requirements as detailed in IRC section R408.3, and the entire space is conditioned and maintained at the same temperature and humidity levels as the above interior living space. These crawl spaces present the ideal circumstances to create a balanced condition below and above the flooring system. IRC section R408.3, ventilation openings in crawlspaces shall not be required where the following items are provided:

- a. Exposed earth is covered with a continuous Class I vapor retarder. Joints of the vapor retarder shall overlap by 6" (152 mm) and shall be sealed or taped. The edges of the vapor retarder shall extend not less than 6" (152 mm) up the stem wall and shall be attached and sealed to the stem wall or insulation; and
- b. One of the following is provided for the crawlspace:
 - i. Continuously operated mechanical exhaust ventilation at a rate equal to 1 cubic foot per minute (0.47 L/s) for each 50 square feet (4.7 square meters) of crawlspace floor area, including an air pathway to the common area (such as a duct or transfer grill), and perimeter walls insulated in accordance with Section N1102.2.22 of IRC, or
 - ii. Conditioned air supply sized to deliver at a rate of equal to 1 cubic foot per minute (0.47 L/s) for each 50 square feet (4.7 square meters) of crawlspace floor area, including a return air pathway to the common area (such as a duct or transfer grill), and perimeter walls insulated in accordance with Section N1102.2.22 of IRC, or
 - iii. Plenum in existing structures complying with Section M1601.5 of IRC, if the crawlspace is used as a plenum, or

iv. Dehumidification sized to provide 70 pints (33 liters) of moisture removal per day for every 1,000 square feet (93 square meters) of crawlspace floor area.

- 4. Vapor retarder installed on the underside of the joists: According to IRC section R408.8, in hot and humid climates (specifically climate zones 1A, 2A, and 3A below the warm humid line), it is a standard requirement for the builder to provide installation of a continuous Class I or Class II vapor retarder to be installed on the exposed face of air-permeable insulation installed between the floor joists, and exposed to the grade in the under-floor space. This vapor retarder shall not be required in unvented crawlspaces constructed in accordance with the IRC Section R408.3.

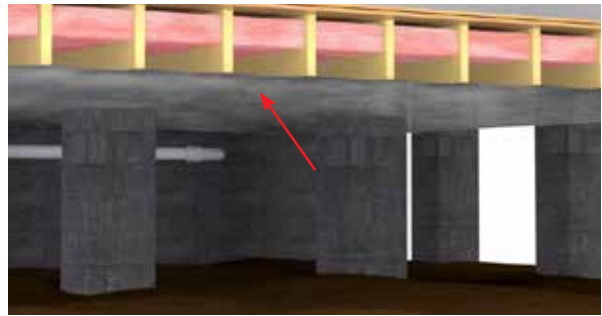

D. Crawlspace Insulation:

- 1. In unconditioned spaces such as open and ventilated crawlspaces, insulation plays an important role in the temperature gradient and moisture migration from an unconditioned space into a conditioned space. Insulation installation should be completed by a qualified professional.
- 2. Building codes in many climate zone regions dictate construction methods related to insulation and moisture control systems installed in crawlspaces.
- 3. Common insulation and vapor retarding systems used below the subfloor include fiberglass batt insulation, closed-cell spray foam insulation, and foil-faced rigid insulation panels.



SUBSTRATES: Wood Subfloors

Wood flooring by design is not to be used to strengthen/stiffen a subfloor and will not do so. The subfloor is the foundation for the wood floor. The final wood floor installation is only as good as the subfloor it is installed over.

With new construction, it is the responsibility of the builder to ensure the facility is designed and capable of sustaining an environment conducive to the building materials being used in it. The wood flooring contractor shall not be responsible for the design or installation of the subfloor system, inadequate deflection limits, improper joist/floor truss spans, and spacing/panel thickness combinations, or any subsequent flooring problems resulting from prior jobsite damage, unless otherwise contracted to do so.

If it is the opinion of the wood flooring contractor that the subfloor is not in suitable condition for hardwood flooring, it is the responsibility of the wood flooring contractor to either remedy the subfloor and/or to notify the builder/owner prior to installation to allow them to make it suitable for the flooring being installed.

PART I Floor Joists and Trusses

Floor joists and trusses are the structural components in a floor framing system that transfer floor loading above to the wall or foundation-bearing supports below. They run between foundations, walls, or beams, and typically are laid out in repetitive patterns. They can be made of solid wood, engineered wood, or steel. You can work with the architect, the builder, and the designer to ensure the facility is designed and capable of maintaining the minimum requirements necessary for the flooring products being used in it.



- A. Traditional lumber joists are usually 2"x or 3"x dimensional material and are sized according to the these factors:
1. Species and grade of the wood.
 2. Spacing and span of the joists.
 3. The design load requirements.



- B. I-joists have a higher strength-to-weight ratio than lumber joists and often are used for longer spans. They use top and bottom flanges that typically are solid lumber, structural composite lumber, or laminated veneer lumber (also called LVL). They also use web material that typically is made of oriented strand board (OSB).



- C. Floor trusses usually are made up of 2"x4" or 2"x3" lumber on top and bottom chords with an open-web configuration with metal plates. The lumber in the floor truss flanges usually is oriented flat-wise providing for up to 3½" wide bearing surfaces. These trusses are often used for longer spans than lumber joists.

- D. Maximum subfloor deflection limits are set by building codes. They are expressed as a fraction: clear span in inches (L) over a given number. Building code allows for the maximum allowable floor member live load and concentrated load deflection for wood framed floor systems to not exceed L/360, where "L" is the clear span length of the supporting members.
1. A subfloor system built to this minimum specification is sufficient for most wood floor installations.
 2. Some thinner-profile (solid and engineered) wood flooring products may benefit from a stiffer subfloor system.
 3. Subflooring systems that lack adequate stiffness can contribute to performance problems in wood floors such as fasteners pulling out of the subfloor, excessive noise, and potential damage to the surface finish. Where subfloor deflection is a concern, a qualified professional can help the end-user determine the best method to stiffen the subfloor system. Some common options for stiffening a subfloor system include:
 - a. Increasing the subfloor panel thickness.
 - b. Adding a second layer of wood panel subflooring to the existing subfloor.
 - c. Selecting a high-performance subfloor product that has a higher design stiffness than commodity panel options.
 - d. Increasing the depth of the floor joists/trusses.
 - e. Selecting a wood grade for the floor joists/trusses with a higher modulus of elasticity.
 - f. Reducing the floor joist/truss spacing.
 - g. Reducing the span of the floor joists/trusses

PART II Wood Panel Subflooring

A. Wood Panel Subfloor Standards:



1. **Plywood subfloor panels** should conform to the most-current U.S. Voluntary Product Standard PS 1 performance standard, for Construction and Industrial Plywood and/or Canadian standards CSA 0153 or CSA 0121, and/or Canadian performance standard CAN 0325. It should also comply with the requirements of the International Residential Code (IRC) and International Building Code (IBC) at the date it was manufactured.



2. **Oriented strand board (OSB) subfloor panels** should conform to the governing version U.S. Voluntary PS 2 and/or Canadian performance standard CAN/CSA 0325 or CSA 0437. It should also comply with the requirements of the IRC and the IBC at the date it was manufactured.
3. Some manufacturers have chosen to produce wood structural panels that have higher strength, stiffness and fastener holding properties than commodity OSB and plywood subflooring. To be recognized as "**high-performance**" subflooring, panels must have an accompanying evaluation report from an approved testing agency substantiating any claims to elevated performance properties. Enhanced performance properties shall be listed in the evaluation report. Proprietary reports typically list these properties as "design values" to be used by specifiers.
4. These standards apply to wood structural panels suitable for use as subflooring material, which should be plywood or oriented strand board with a bond classification of Exposure 1 or Exterior. Alternative wood-based structural panels are permitted if recognized in a current Evaluation Report from an approved testing source as satisfying the requirements for subflooring in the governing building code.

B. Wood Panel Subfloor Identification:

1. When possible, check the back of the subfloor panel for identifying information about the panel such as span rating, thickness, and exposure rating. This information is listed within the third party certifying agency stamp. Flooring assemblies (joist/floor truss spacing and panel thickness) must be designed and constructed to accommodate design loads and the floor covering being installed over it.
2. When evaluating the wood panel subfloor, the underside of the installed panel should contain a product grade stamp from an accredited testing agency indicating that it complies with the governing product standard (PS 1 or PS 2) at the time it was manufactured. Common accredited testing agencies for OSB and plywood subfloors are APA (The Engineered Wood Association), PFS TECO (PFS Corporation and Timberco Inc.), and TPI (Timber Products Inspection). The information included in each of these stamps is detailed here:

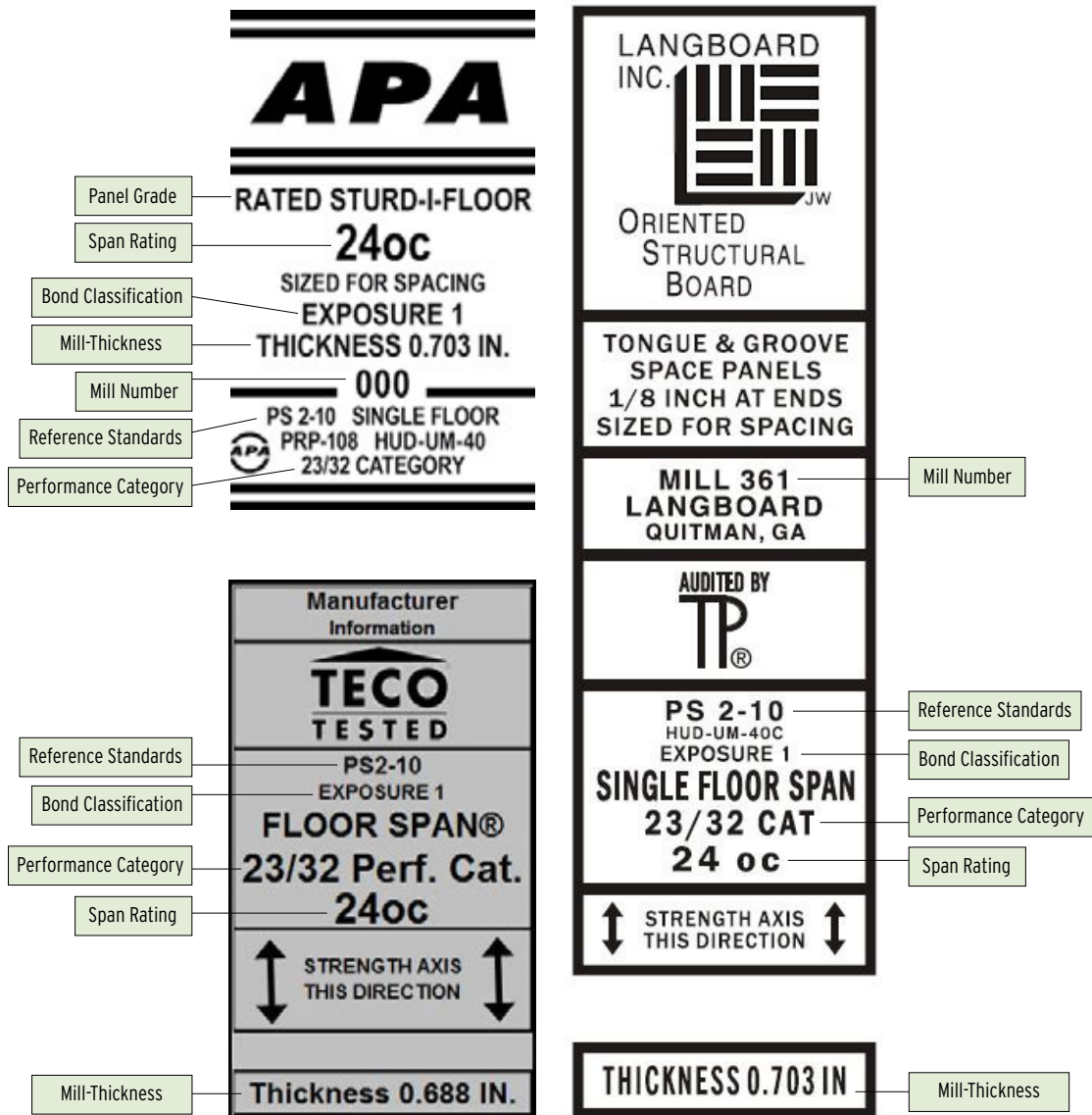

Panel grade: identifies the intended use of the panel.

Span rating: maximum for roof spans/maximum for floor joist span.

Bond classification: indicates how much weather and moisture the panel is designed to withstand.

Mill-thickness: thickness of the material.

Mill number: Identifies the Mill ID #.

Reference standards: industry standard designations.

Performance category: nominal thickness of product.

Wood Panel Performance Category for Plywood or OSB

PERFORMANCE CATEGORY (NOMINAL THICKNESS)	MILL THICKNESS LABEL
1/4	0.225 in. (5.715 mm)
11/32	0.322 in. (8.179 mm)
3/8	0.354 in. (8.992 mm)
7/16	0.418 in. (10.617 mm)
15/32	0.451 in. (11.455 mm)
1/2	0.483 in. (12.268 mm)
19/32	0.578 in. (14.681 mm)
5/8	0.609 in. (15.469 mm)
23/32	0.703 in. (17.856 mm)
3/4	0.734 in. (18.644 mm)
13/16	0.788 in. (20.015 mm)
7/8	0.849 in. (21.565 mm)
1	0.970 in. (24.638 mm)
1-1/8	1.091 in. (27.711 mm)
1-1/4	1.213 in. (30.810 mm)

PART III

Wood Panel Subfloor Installation Requirements

- A. Single floor subfloor panels should be installed continuous over two or more spans, with the long panel dimension (strength axis) perpendicular to floor trusses or joists. All panel edges not supported continuously with framing shall be tongue and groove.
- B. To minimize the potential for floor squeaks, most wood panel subfloor manufacturers recommend that the subfloor panels be glued and nailed to the floor framing using recommended fasteners and subfloor adhesives conforming to ASTM D3498 or APA Specification AFG-01. Joist spacing greater than 16" on center (O.C.) must be glued and fastened. A thin bead of glue inside the groove profile is also sometimes recommended.
- C. The ends of the panels should land at the center of the floor joist/truss, with a minimum bearing of 1/2".
- D. Glue-nailed subfloor panels up to 23/32" thick should be fastened with 6d ring- or screw-shank nails, 8d common nails, or proprietary screws spaced 6" O.C. along panel edges and 12" O.C. along intermediate supports. Some subfloor panel manufacturers may have more-restrictive fastener requirements.
- E. Typical panel edge spacing requirements for floor joist/truss systems call for 1/16" - 1/8" gap around the perimeter (all four sides) of each panel. Some panel manufacturers mill their tongue and groove edges to gap themselves.

NOTICE: For additional information on the installation of Wood Panel Subflooring, see APA's *Engineered Wood Construction Guide* (Form E30) at www.apawood.org or refer to the panel manufacturer's recommendations.

Joist/Floor Truss Spacing & Panel Thickness Requirements for Wood Flooring Installation

WOOD SUBFLOORS ≤16" JOIST SPACING

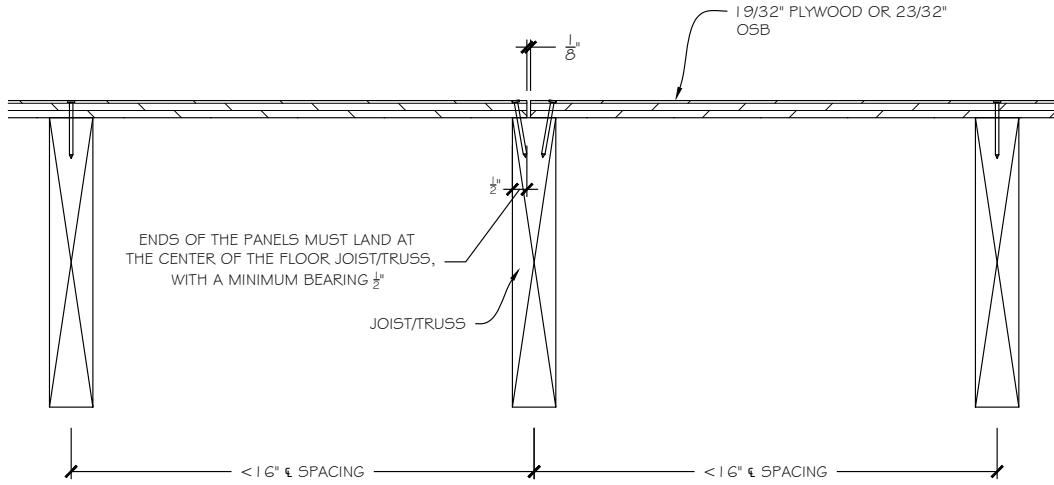

JOIST SPACING	MINIMUM SUBFLOOR PANEL PERFORMANCE CATEGORY
≤16" (406 mm)	19/32 plywood or 23/32 OSB

WOOD SUBFLOOR >16" & ≤19.2" JOIST SPACING

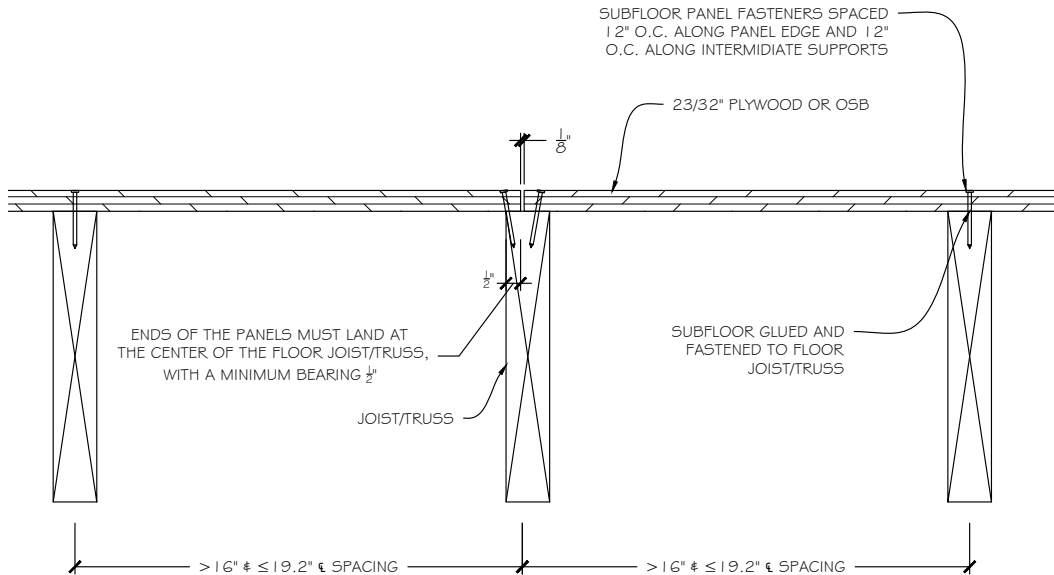

JOIST SPACING	MINIMUM SUBFLOOR PANEL PERFORMANCE CATEGORY
>16" and ≤19.2" (488 mm)	23/32 plywood or OSB

NOTE: Where minimum building code is less-restrictive than NWFA recommendations, the existing subfloor will require installation of a double-layer subfloor system.

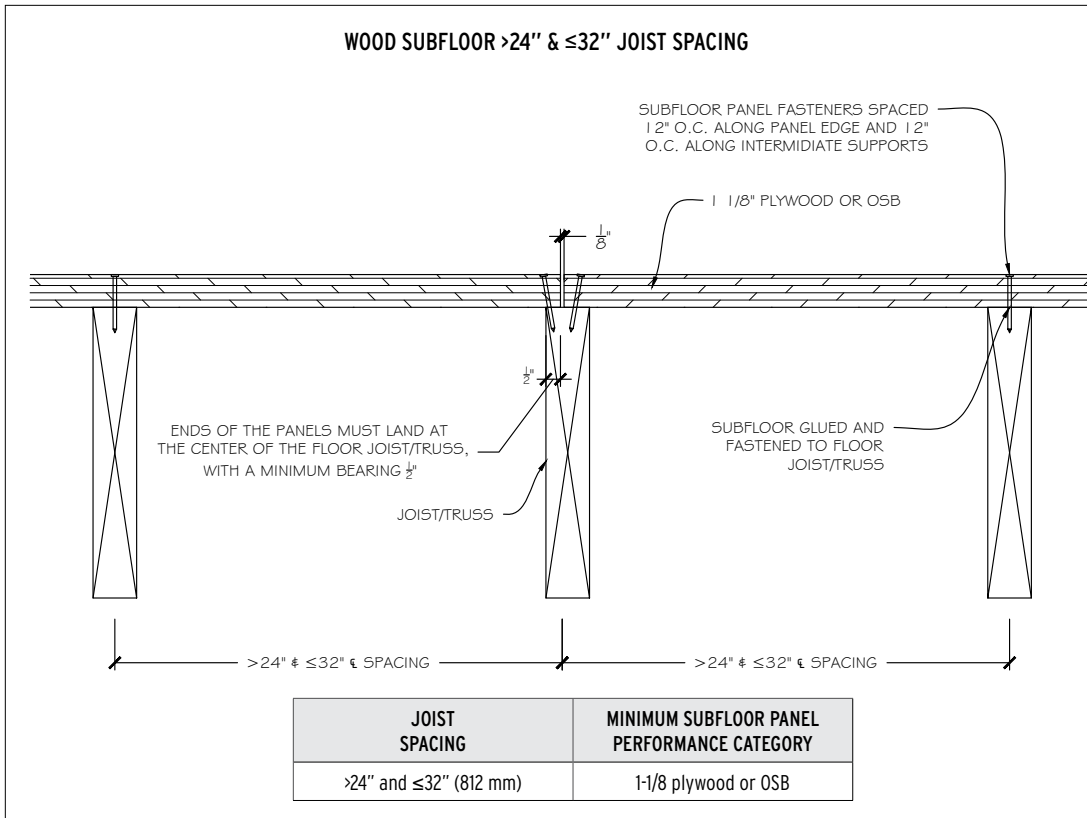
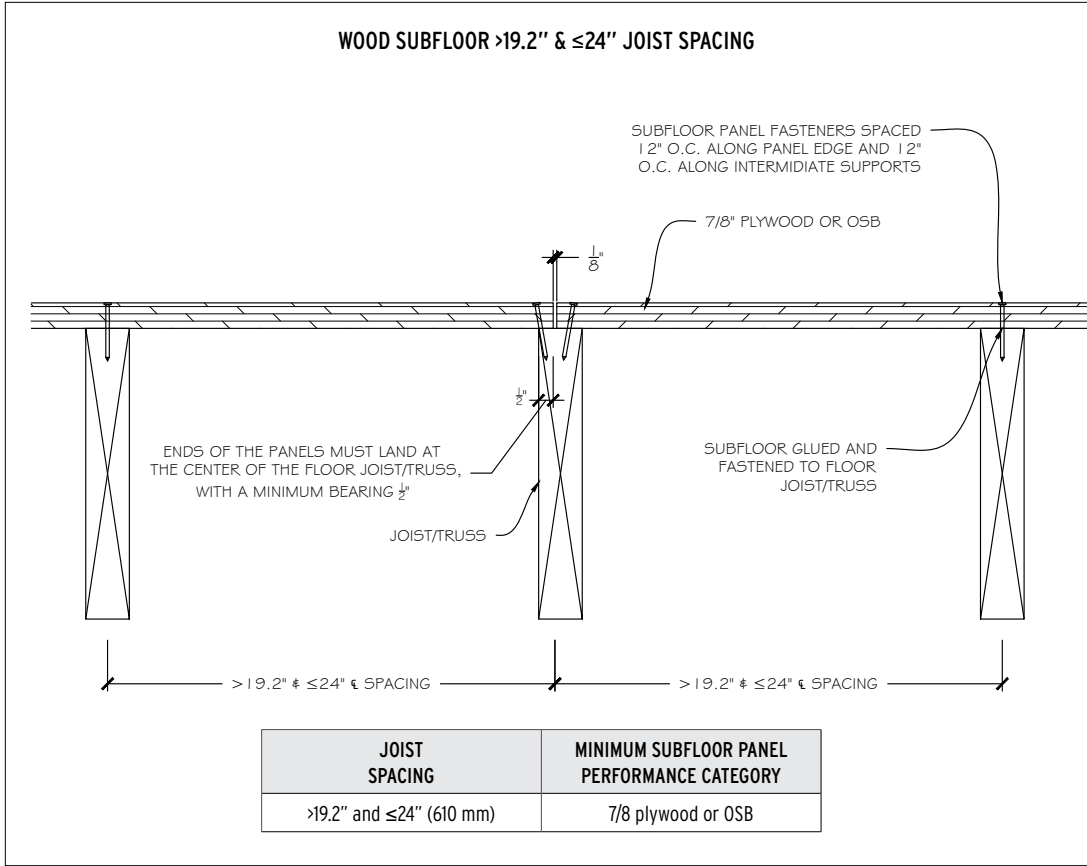

NOTE: Where minimum building code is less-restrictive than NFA recommendations, the existing subfloor will require installation of a double-layer subfloor system.

PART IV Double-Layer Subfloor Systems

- A. For double-layer floors (one subfloor layer and a second (top) layer of underlayment), panels should be plywood or oriented strand board (OSB), Exposure 1, manufactured according to U.S. Product Standard PS 1 or PS 2, or Canadian standard CSA O121, O151, O325, or O437.
- B. Before installing a second layer, allow the panels to acclimate in the area where they will be installed. The lower layer of subfloor panels should also be dry as noted in the Subfloor Moisture section of this chapter.
- C. Where the existing base layer panel thickness and joist spacing combination do not meet NWFA or manufacturer minimum guidelines, install a second layer over the subfloor:

1. The second (top) layer should be a minimum 15/32 (.451 in.) subfloor panel.
2. The 15/32 panels should be oriented perpendicular to the floor framing and the long (strength axis) edge, offset by minimum 4" and end joints by at least one joist space. Panels may also be laid on diagonal to the existing subflooring. No base layer seams should align with the top layer seams.
3. 1/16" - 1/8" gap must be maintained around the perimeter (all four sides) of each panel, as well as 3/4" gap at all vertical obstructions.
4. The second layer of panels should be fastened at a minimum of 6" O.C. along all panel edges and 12" O.C. grid pattern through the field. Use only ring- or screw-shanked nails, proprietary screws, or equivalent fasteners with attachment only through the entire subfloor panel, but not penetrating through to the floor joists. Application of an elastomeric wood floor adhesive to adjoin the two panels together may not be recommended by the subfloor panel manufacturer. Follow manufacturer instructions.

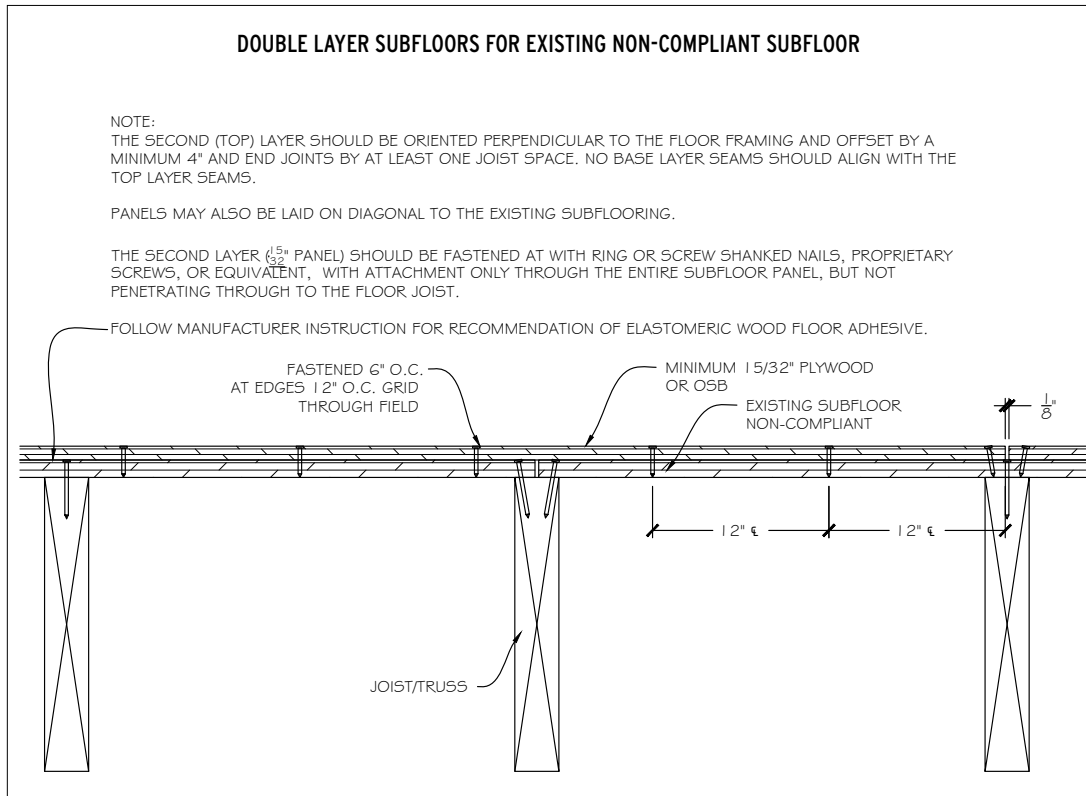

NOTE: Where minimum building code is less-restrictive than NWFA recommendations, or where thinner-profile (solid and engineered) wood flooring products require a stiffer subfloor system, the existing subfloor will require installation of a double-layer subfloor system, or additional structural supports designed and installed by a qualified professional, or replacement of the subfloor to conform to NWFA Guidelines.

D. Where the existing base layer is particleboard or solid board subfloor, where removal is not an option, and it does not meet NWFA or manufacturer minimum guidelines for the flooring being installed:

1. The second (top) layer should be overlaid with a minimum 19/32 subfloor panels.
2. The 19/32 panels should be oriented perpendicular to the floor framing and offset by a minimum of 4", and end joints by at least one joist space. Panels may also be laid on a diagonal to the existing subflooring. No base layer seams should align with the top layer seams.
3. 1/16" - 1/8" gap must be maintained around the perimeter (all four sides) of each panel, as well as 3/4" gap at all vertical obstructions.

4. The second layer of panels should be fastened at a minimum of 6" O.C. along all panel edges and 12" O.C. grid pattern through the field. Use only ring- or screw-shanked nails, proprietary screws, or equivalent fasteners with attachment only through the entire subfloor panel, but not penetrating through to the floor joists. Application of an elastomeric wood floor adhesive is often necessary in joining the two panels together.

NOTICE: For additional information on the installation of underlayment grade panels, see APA publication L335 at www.apawood.org or refer to the panel manufacturer's recommendations.

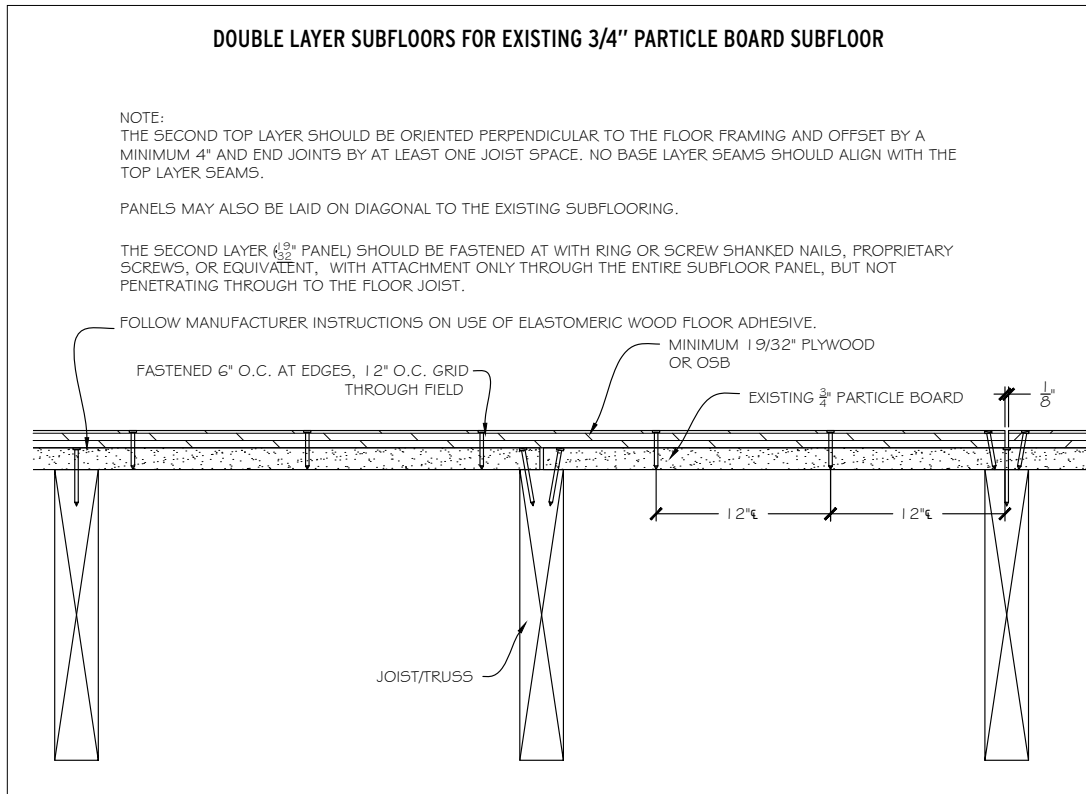

DOUBLE LAYER SUBFLOORS FOR EXISTING 1 X 6 SOLID BOARDS REQUIRING AN OVERLAY

NOTE:

THE SECOND TOP LAYER SHOULD BE ORIENTED PERPENDICULAR TO THE FLOOR FRAMING AND OFFSET BY A MINIMUM 4" AND END JOINTS BY AT LEAST ONE JOIST SPACE. NO BASE LAYER SEAMS SHOULD ALIGN WITH THE TOP LAYER SEAMS.

PANELS MAY ALSO BE LAID ON DIAGONAL TO THE EXISTING SUBFLOORING.

THE SECOND LAYER ($\frac{3}{4}$ " PANEL) SHOULD BE FASTENED AT WITH RING OR SCREW SHANKED NAILS, PROPRIETARY SCREWS, OR EQUIVALENT, WITH ATTACHMENT ONLY THROUGH THE ENTIRE SUBFLOOR PANEL, BUT NOT PENETRATING THROUGH TO THE FLOOR JOIST.

FOLLOW MANUFACTURER INSTRUCTIONS ON USE OF ELASTOMERIC WOOD FLOOR ADHESIVE.

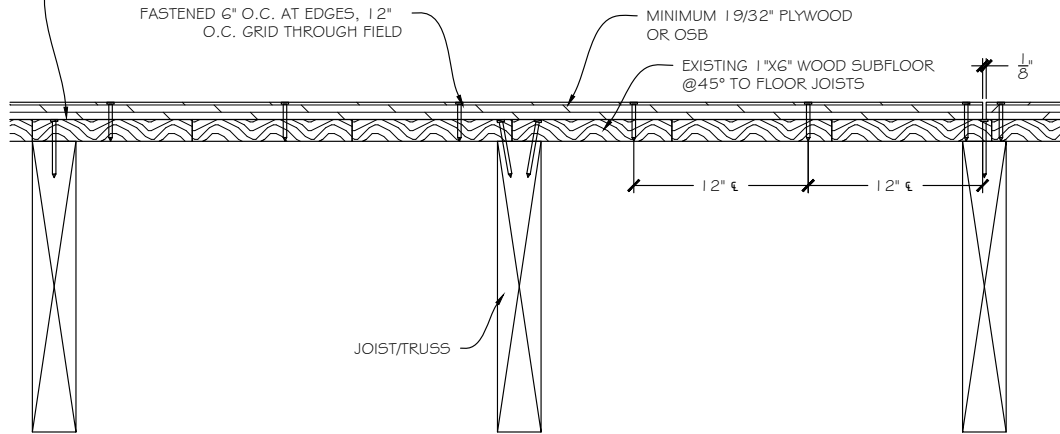

**PART V
Solid-Board Subflooring**



A. Solid board subflooring should be $\frac{3}{4}$ " x $5\frac{1}{2}$ " (1" x 6" nominal), Group 1 dense softwood, No. 2 Common, kiln-dried and at a moisture content that coincides with the expected "in-use" conditions of the space and the wood flooring being installed. (Reference R503.1 of the most-current IRC.)

- B. Solid-board subflooring should consist of boards no wider than 6", installed on a 45° angle to the joists, with all board ends full bearing on the joists and fastened with minimum 8d rosin-coated or ring-shanked nails, or equivalent.
- C. Installation of any of the following wood floors over a solid board subfloor will require replacement of the subfloor to conform to NWFA Guidelines, or installation of a double-layer subfloor system (see Part IV).
 1. Engineered flooring less than $\frac{3}{4}$ " thick.
 2. Thin-classification (less than $\frac{3}{4}$ " thick) solid wood flooring.
 3. Parquet wood flooring.
 4. End-grain blocks.

PART VI Particleboard



- A. Particleboard is a wood composite material (also known as waferboard, chipboard, or pressboard) manufactured from wood particles including wood shavings, chips, or dust, and synthetic resins or other suitable binders, then pressed into panel products.
 - 1. Particleboard must be a minimum 40-lb. density, stamped underlayment grade.
- B. Nail-down installations:
 - 1. Particleboard is not an acceptable underlayment for nailing down any wood floor, due to the inability of these products to hold fasteners or retain their integrity when fasteners are driven through.
 - 2. For nail-down installations where particleboard exists, replacement of the subfloor to conform to NWFA Guidelines, or installation of a double-layer subfloor system (see Part IV) is required.
- C. Glue-down installations:
 - 1. Due to the inherent instability of particleboard, glue-down is normally not recommended installation method. Check with the adhesive manufacturer before

proceeding with any glue-down installation over particleboard subflooring.

- 2. For glue-down installations where particleboard exists, and the adhesive is not recommended or compatible, replacement of the subfloor to conform to NWFA Guidelines, or installation of a double-layer subfloor system (see Part IV) is required.
- D. Particleboard is an acceptable subfloor for floating floor installations.

PART VII Wood Subfloor Integrity

- A. The subfloor should be sound. Evaluate the subfloor carefully prior to installation of the wood floor. If there is movement, objectionable noises, water damage, delamination or damaged areas of the subflooring material, damage within the subfloor system, or if the subfloor simply doesn't meet minimum standards for the wood floor being installed, it should be appropriately addressed by a qualified professional before installation of the wood floor.
- B. Do not install flooring over any observed issues without first addressing with the builder, general contractor, architect, homeowner, or any other responsible party prior to installation of new flooring.
- C. Floor squeaks or other objectionable noises may be addressed according to panel manufacturer requirements or APA Technical Note C468 (Floor Squeaks: Causes, Solutions and Prevention). Use of screws to address noisy floors is a common practice. Be mindful of what lies beneath the subfloor before driving screws into it.
- D. Protruding or loose fasteners should be remedied by either removing them or driving them deeper into the subfloor.
- E. Document your findings by taking photographs and notes in the Jobsite Checklist.

PART VIII

Wood Subfloor Flatness

- A. Subfloor flatness is one of the many considerations that should be addressed before installation of any wood floor. With new construction, use caution addressing subfloor repairs yourself. Outside of sanding seams, the builder should address any substrate issues before any wood floor is delivered to the jobsite.
- B. Subfloor flatness should be measured across the span of each room receiving wood flooring to get an overall perspective of the topography of the subfloor. The floor does not need to be level in most situations, but should be flat.
- C. Where one room meets another, the subfloor flatness should remain in tolerance. Where adjoining rooms are not within tolerance, are on a separate plane, or abutting a ramp, a specialty or customized transition separating each floor, will be necessary.
- D. Assessing Wood Subfloor Flatness: Measure subfloor flatness using a laser-level, string-line, or straight-edge by taking measurements across the plane of the line to determine tolerances.
 - 1. **Laser-level:** Place the laser level on the floor in the room receiving wood (ideally at the highest point of the subfloor). Lasers featuring a 360° static or rotating beam allow you to take measurements from the subfloor to the plane of the laser at any given point within the room. Measure the deviations in the subfloor by using a tape measure, taper gauge, feeler gauge, depth finder, calipers, or the target provided by the laser manufacturer.
 - 2. **String-line:** Place two blocks of wood (of the same thickness) at each end of the room, and then run a taught string-line across them. Take multiple measurements across the string-line between the blocks from the line to the subfloor. Measure the deviations in the subfloor by using a tape measure, taper gauge, feeler gauge, depth finder, or calipers. Move the blocks to multiple locations down each wall to cover the entire floor space.
 - 3. **Straight-edge:** Place the straight edge across the substrate. Take multiple measurements across the straight-edge between the edge and the subfloor. Measure the deviations in the subfloor by using a tape measure, taper gauge, feeler gauge, depth finder, or calipers. Move the straight-edge to multiple locations, and rotate it 180° at each location to cover the entire floor space.
- E. Mark out any discrepancies on the subfloor itself, giving a good indication of what alterations will be necessary. Document and photograph the results.
- F. For installations using mechanical fasteners of 1½" and longer, the subfloor should be flat to within minimum tolerance of 3/16" in 6', or ¼" in 10', unless otherwise specified by the wood flooring manufacturer. For glue down installations, floating installations, and installations using mechanical fasteners of less than 1½", the subfloor should be flat to within minimum tolerance of 1/8" in 6', or 3/16" in 10', unless otherwise specified by the wood flooring manufacturer.
- G. Addressing Wood Subfloor Flatness:
 - 1. High Spots
 - a. Use caution when sanding wood subfloors, as breathing wood particles may cause allergic respiratory symptoms, mucosal and non-allergic respiratory symptoms, or even cancer. Proper use of a respirator minimizes the effects of these airborne particulates.
 - b. Sand all of the abutting subfloor seams throughout the entire layout. Sanding seams is necessary on most jobs due to the tendency of wood panels to swell at the edges (known as edge-swell) when exposed to rain, snow, or construction-related moisture introduced during the construction process. Some manufacturers produce higher performing grades of OSB that are less prone to edge swell than typical commodity-grade panels.
 - c. Sand the seams flat with either an edger or a buffer with coarse grit sandpaper.
 - 2. Low Spots
 - a. **Overlays:** A common method to flatten wood subfloors to the required tolerance in remodel situations. (Note: Minor overlay repairs used to build up low spots in the subfloor may, depending on how much build-up is necessary, decrease the fastener penetration into the wood subfloor, and may increase the potential for squeaks, crackles, pops, or overall disengagement from the subfloor. Use of longer fasteners and adhesive may assist in minimizing these risks.)
 - i. Underlayment material may be used to build slight elevation gains. In general, vapor retarding membranes such as 15# felt or asphalt-saturated kraft paper are normally just shy of 1/64" thick.

- ii. Plywood allows for better build-up with lower undulations in the subfloor. Plywood is available in many thicknesses that can allow for drastic build-up where necessary.
 - Build up from the lowest elevation, using the products that allow for enough incremental elevation gain to get to within flatness tolerance.
 - Using an elastomeric wood flooring adhesive along with screws will help minimize any potential for inadvertent noises such as squeaks or pops.
 - Any ridges at the panel edges should be sanded flat using an edger with coarse grit sandpaper. (Note: Proper use of a disposable particulate respirator minimizes the effects of these airborne particulates. See Safety Chapter for more detail.)
 - iii. Sheet vinyl products, such as linoleum, may range up to 1/8" in thickness. Many tear-outs include removal of linoleum to be replaced with wood floors. This can be a way to repurpose old material. (NOTE: Some of these types of floor coverings installed in homes built prior to 1986 could contain asbestos. Refer to the Safety chapter for more detail).
 - iv. Cedar shims can give elevation gain from 0 to 3/8" within a short 15" span. When elevation gain requires more, customized screeds planed to the necessary thickness may be necessary. Install the shims in a bed of elastomeric wood flooring adhesive to ensure a sound base for the wood flooring installation.
 - v. Self-levelers are not normally approved or recommended for use over non-dimensionally stable subfloors such as OSB or plywood. More importantly, you cannot nail through them. Check with your manufacturer for use and compatibility of these types of products over wood floors if you are considering a glue-down or floating installation.
 - vi. A combination of multiple methods may be necessary to get the floor flat to within tolerance.
- b. **Removals:** Prior to removal of any subflooring, determine whether the sagging/low areas are in any way structural. In some cases, a structural engineer or qualified builder may need to assess the situation to make this determination. Also note that in many jurisdictions, if you "cut" or "alter" the structure in any way, a building permit will be required. Altering the structure would include removal of the subflooring to access the joists in order to make necessary corrections.
 - i. The following are common methods for addressing the joists before reinstalling the subflooring material:
 - **Planing:** the existing floor joists, which includes removal of material to bring the elevations to within tolerance after the subfloor is replaced.
 - **Sistering:** material to get the elevations within tolerance, which is the reinforcement of a joist by nailing, or attaching alongside the existing joist, another joist, or reinforcing member.
 - **Replacement:** the joists altogether, which requires removal and replacement of entire joists. Keep in mind, plumbing lines and electrical wiring/conduit are often run through/or alongside the joists, and will add to the difficulty of the replacement.
 - ii. Be mindful that doing any of these repairs also opens the flooring contractor up to potential liabilities due to the completion of work outside of the wood flooring profession. This work may also require alternative/upgraded insurance policies, state licensing requirements, building permits, as well as further training or qualification of this skillset.

PART IX

Wood Subfloor Moisture



- A. With new construction, it is the responsibility of the builder to control moisture during the building process by protecting moisture-sensitive and porous materials (such as wood panel subflooring) during transport and on-site storage, and by drying wet materials before they are enclosed inside building assemblies or covered by finish materials.
- B. Check with your moisture meter manufacturer for the proper species correction setting for the subfloor material being tested. If you are unable to determine the proper species correction for your moisture meter, find other wood materials within the structure that are at equilibrium moisture content, and use this value as your “base” for testing the subfloor. (See Moisture Testing chapter for more-detailed information on moisture testing wood subfloors.)
- C. In hot and humid climates, and during the humid season, the subflooring should not exceed 13% moisture content (MC). In regions where equilibrium moisture content (EMC) within the facility can sustain these higher MC levels, additional precautions should be implemented through the flooring product selection and the acclimation/conditioning process. (See Acclimation/Conditioning chapter for more information.)
- D. When subjected to water from leaks, flooding, rain, or snow (during construction), wood panels have the potential to absorb moisture, which may result in swelling and expansion in panel length, width, and thickness.
1. **Plywood:** swelling, distortion, linear expansion, and delamination can occur when exposed to high levels of moisture. Moisture tests should be conducted using insulated pin, hammer probe type meters on the surface, on the backing, and within the core of the material in several areas of the damaged material to properly assess the extent of moisture intrusion. Replace the plywood when the damage is evident. Ensure replacement material is within acceptable MC ranges prior to reinstallation of wood flooring.
 2. **Oriented Strand Board (OSB):** swelling and linear expansion can occur with OSB when exposed to water. Swelling, and subsequent drying in OSB can result in a decrease in density and a reduction in within-board strength due to the release of compaction stress created during the pressing process of manufacturing. This will directly affect how existing fasteners hold the wood flooring to the subflooring material. Replace when damage is evident. Ensure replacement material is within acceptable MC ranges prior to reinstallation of wood flooring.
- E. Subsequent drying of previously wetted panels may result in shrinkage of the wood. Wood panels typically can tolerate short-term wetting, but they must be dry to an adequate MC level before flooring is installed over them.
1. If wood flooring is installed prior to adequate subfloor drying, the eventual shrinkage in the subfloor can result in gaps along wood flooring joints, gaps between the flooring and subflooring, and noisy floors from a reduction in fastener holding capacity.
 2. Installing wood flooring prior to adequate drying can also result in expansion of finished flooring as strips or planks absorb moisture from the subfloor.

SUBSTRATES: Concrete Subfloors

Understanding the basics of concrete can help ensure successful wood flooring installations. The subfloor is the foundation for the wood floor. The final wood floor installation is only as good as the subfloor it is installed over. In the event of subfloor failure, the wood flooring contractor shall not be responsible for the performance of the subflooring material, or any subsequent flooring damage resulting from prior jobsite damage, unless otherwise contracted to do so.

PART I Components of Concrete

A. Concrete is comprised of four main materials: Portland cement, coarse aggregate (stone), fine aggregate (sand), and water. When water is introduced to the dry materials, a chemical reaction occurs that is known as hydration.

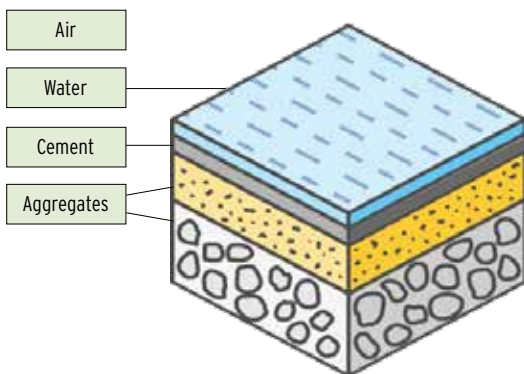

1. Water comprises about 14 to 21 percent of concrete.
2. Cement comprises about 7 to 15 percent of concrete.
3. Aggregates, which can include materials like sand and gravel, comprise about 60 to 75 percent of concrete.
4. Air can comprise up to 8 percent of concrete.

B. The more water that is added to the cement mixture, the more permeable the cement paste will become. The ratio of the amount of water to the amount of concrete in a mixture is referred to as the water-to-cement ratio (w/c).

1. The w/c is determined from the following equation: w/c equals the weight of the water divided by the weight of the cement.

$$w/c = \frac{\text{weight of water}}{\text{weight of cement}}$$

2. A concrete mixture with a high w/c will produce concrete that is weaker and more permeable than a concrete mixture with a low w/c.
 3. The amount of water that is necessary strictly for the hydration of the cementitious materials in a concrete slab mixture falls between 0.25 and 0.28. However, at that low of a w/c, the concrete is not workable. It is for the purpose of creating a workable concrete mixture that additional water is added.
 4. Concrete mixtures designed and used for slab construction typically fall between a w/c of 0.42 and 0.50. The excess water that is added to create workable concrete is referred to as "free water," or "water of convenience." This excess "free water" is not consumed in the hydration reaction and is the first source of rising moisture that can adversely affect a wood flooring installation.
- C. Under "ideal" conditions that include concrete with a w/c of 0.50 or lower, a non-burnished concrete finish where a membrane-forming curing compound was not used, and favorable drying conditions surrounding the slab, it may take 30-45 days after placement before you can begin evaluating it for flooring. (This does not indicate that any slab that is 30 days old is ready to receive flooring.)

PART II Types of Concrete Subfloors

As a flooring installer, you should be able to identify the different types of concrete subfloors over which you will be installing wood flooring. The type of concrete subfloor affects how you will conduct moisture tests, how you will prepare the slab, the type of installation method, and potentially what type of flooring you will be able to use. Follow the adhesive manufacturer's instructions for appropriate subflooring.

A. **Slab-on-Grade** (also called a slab on-ground) is a concrete slab poured on the ground that is typically 4"-6" in thickness.

1. The concrete slab is required to be protected from ground moisture with an effective and intact Class I vapor retarder that conforms to the requirements of ASTM E1745 (Standard Specification for Water Vapor Retarders Used in Contact with Soil or Granular Fill under Concrete Slabs), or specification ASTM E1993 (Standard Specification for Bituminous Water Vapor Retarders Used in Contact with Soil or Granular Fill Under Concrete Slabs) installed in accordance with the recommendations of ACI 302.2R (Guide to Concrete Slabs that Receive Moisture-Sensitive Flooring Materials).
2. The vapor retarder must be installed directly below the slab.

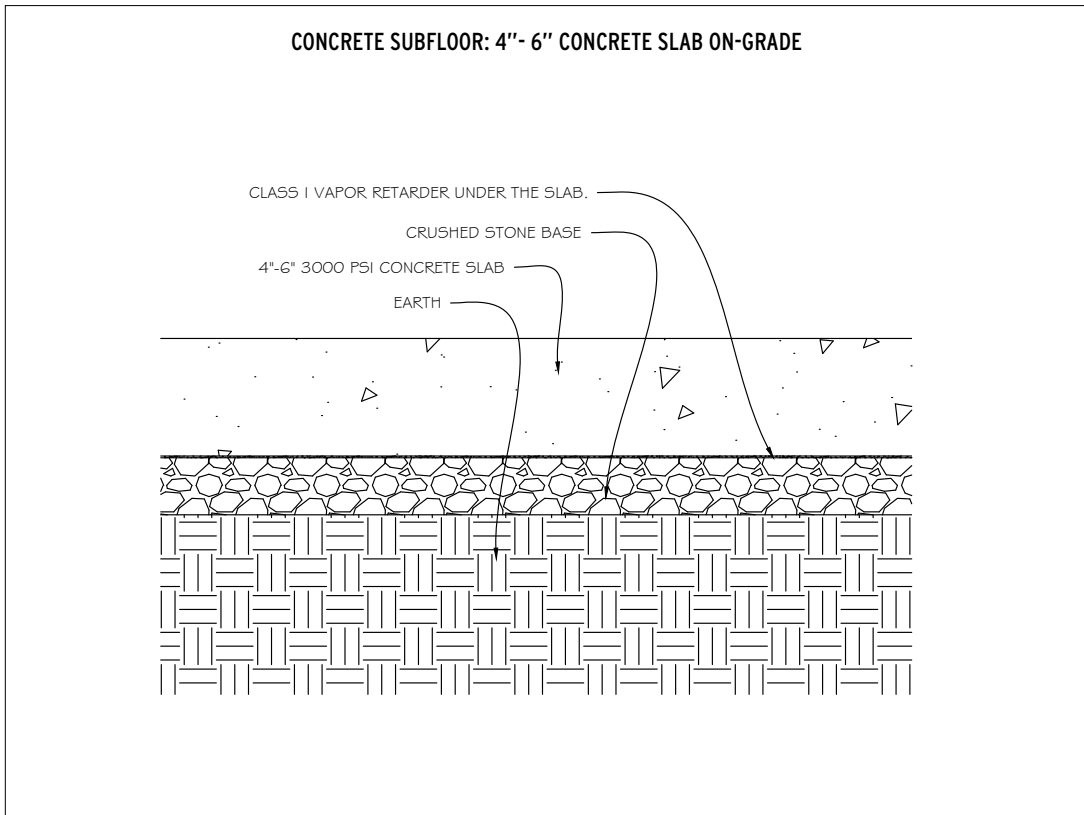

- B. An **elevated concrete slab** may be one of the following designs:
1. Normal or lightweight concrete on metal decking.
 - a. Concrete slabs on metal decking experience the greatest measure of deflection.
 - b. Because drying is only possible from the top surface, such construction usually requires additional drying time.



CONCRETE SUBFLOOR: ELEVATED SLAB ON METAL DECKING

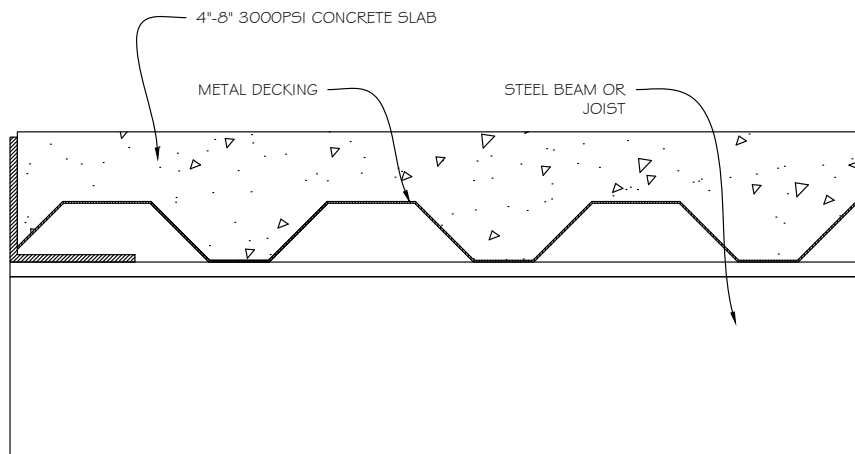

2. Cast-in-place structural concrete. Cast-in-place structural concrete is a technology in the construction of buildings where walls and slabs of the buildings are cast at the site using formwork.



ELEVATED CONCRETE SLAB CAST-IN-PLACE-STRUCTURAL

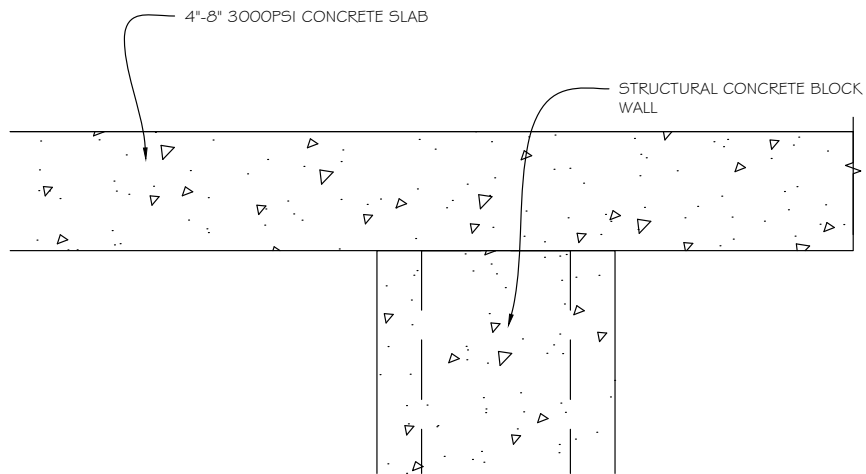

3. Cast-in-place post-tensioned concrete. Post-tensioning is accomplished where the tendons are stressed and each end is anchored to the concrete section after the concrete has hardened.

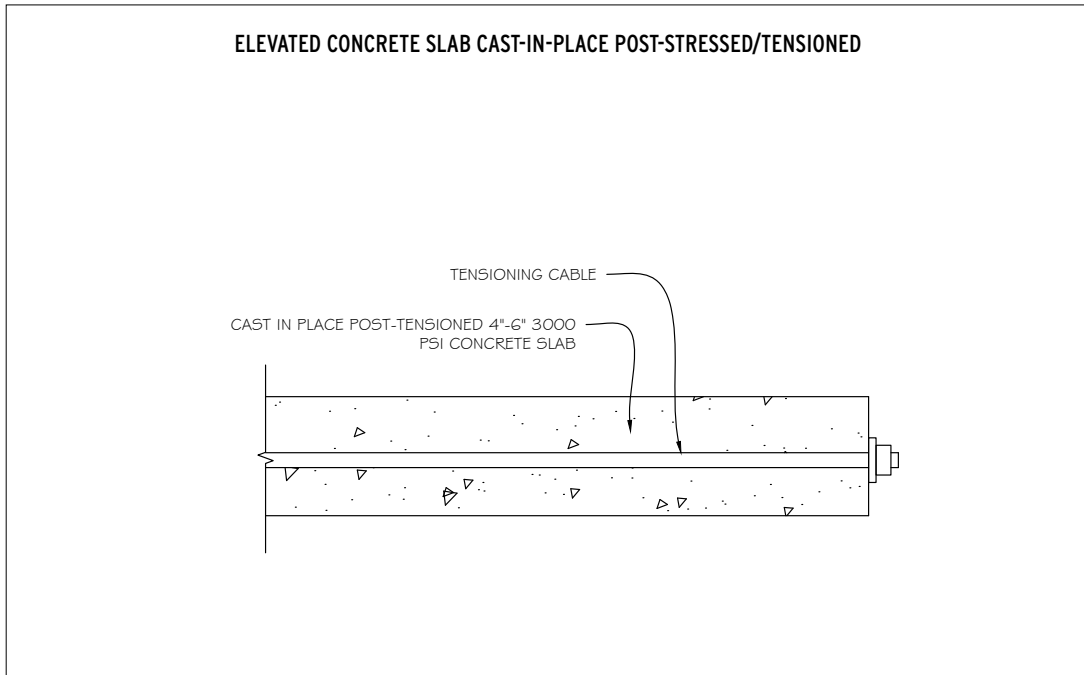

4. Prestressed concrete members.
 - a. Prestressed concrete is a method for overcoming concrete's natural weakness in tension.
 - b. Pre-tensioning is accomplished by stressing wires or tendons, to a predetermined amount, by stretching them between two anchors prior to pouring concrete.

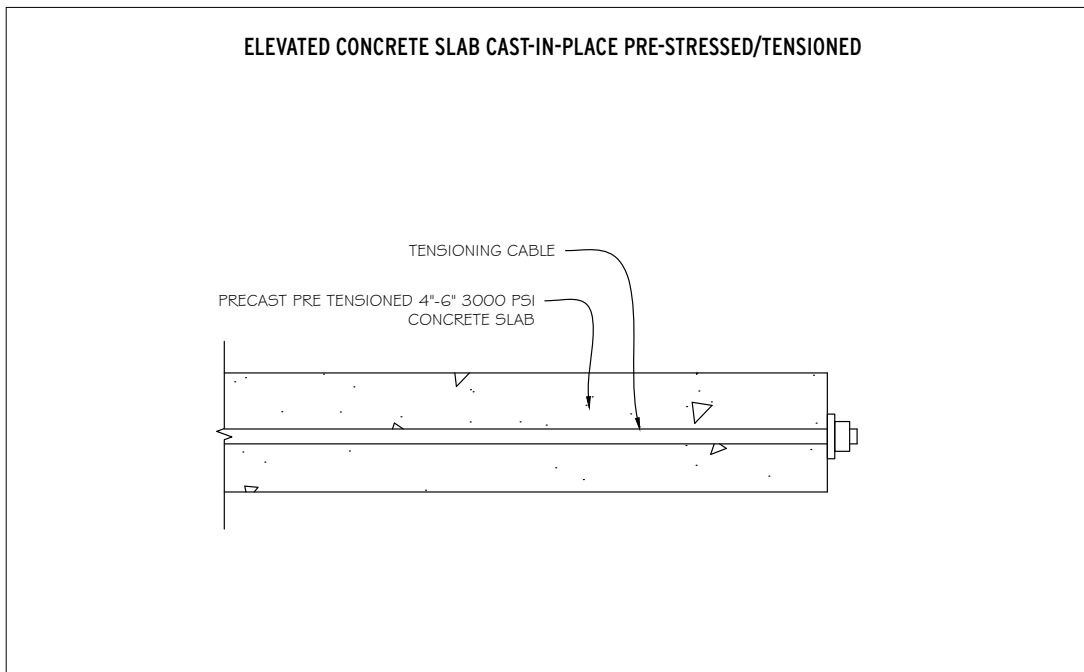

- 5. Precast concrete is a construction product produced by casting concrete in a reusable mold or "form" that is then cured in a controlled environment, transported to the construction site, and lifted into place. In contrast, standard concrete is poured into site-specific forms and cured on site.

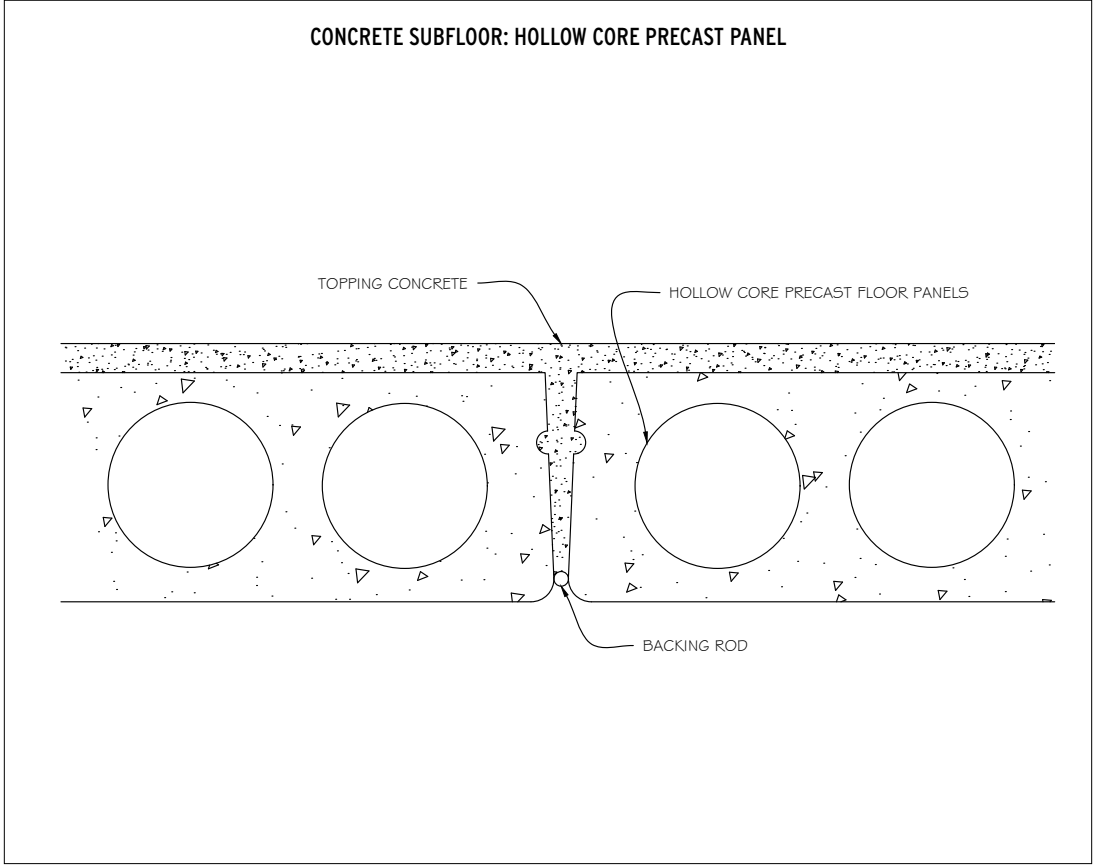

6. When testing moisture in an elevated concrete slab, it is important to know which design is present.
 - a. For concrete slabs on fluted metal decking, concrete internal relative humidity tests (ASTM F2170) are to be taken at 40% of the slab thickness in the deepest part of the flute.
 - b. For structural slabs, where the concrete is free to lose moisture from both the top and bottom, concrete internal relative humidity tests are to be taken at 20% of the slab thickness.
 - c. For any post-tensioned or pre-tensioned slabs, you must identify where the wires or tendons are located within the slab prior to drilling any holes for relative humidity tests.

PART III Concrete Subfloor Joints

There are three types of joints typically found in residential and commercial concrete floor slabs.

CONSTRUCTION JOINTS



- A. **Construction/cold joints:** Construction/cold joints are those points within a concrete placement that either by design, or necessity, the placement of one slab of concrete meets another slab of concrete. Construction/cold joints are weakened joints that, upon movement, will shift, and will affect the flooring installed over them.

CONTRACTION JOINTS

Sawcut or Tooled

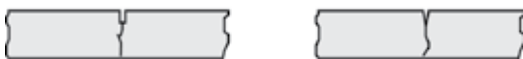

- B. **Control/contraction joints:** Control/contraction joints are planes of weakness purposely introduced into a concrete floor slab that encourage the cracking that develops due to drying shrinkage to occur in an orderly, predetermined pattern rather than randomly. Control/contraction joints are most commonly created by forming, tooling, or by making saw cuts in the new slab to a prescribed depth, most often 1/4 of the slab thickness.

ISOLATION JOINTS

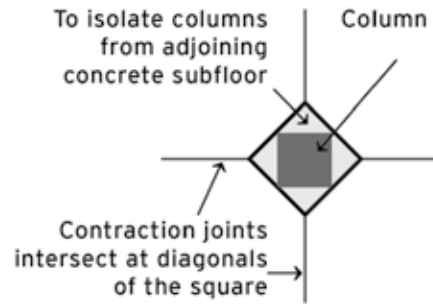

- C. **Isolation joints:** Isolation joints are those joints where the slab abuts a fixed object such as a wall, column, or foundation base, and bond is not desired.
- D. Other classes of joints are acoustical joints and expansion joints.
 1. **Acoustical joints** form a non-hardened, rubber-like seal at the perimeter and at all penetrations and retaining surfaces of a floor installation assembly in which a bonded sound reduction membrane has been installed for sound reduction. The primary function of an acoustical joint is to minimize the transmission of sound through joints, penetrations, or structural components within the assembly.
 2. **Expansion joints** allow movement where expansion is likely to exceed contraction. Expansion joints are normally filled with compressible filler material allowing for independent movement between adjoining slabs.
- E. Joints in a concrete slab typically are specified by the architect or engineer and noted on the architectural and/or structural drawings.
- F. Moving joints must be honored and not be filled with underlayment products or other materials.
- G. Wood flooring secured to the substrate should not bridge moving joints without allowing for a breaking point. When concrete decides to move, it is going to move.
- H. Transitions and/or expansion space should be built into the wood flooring system to avoid potential wood floor damage at these locations in case of future movement.
- I. Identify joints within the slab and address them with the flooring installation appropriately. The end-user should be made aware of the additional installation necessities and costs for any specialized installation methods required when addressing these joints.

PART IV

Compressive Strength

- A. The builder or architect should be able to let you know what type of concrete is present in order for you to determine proper preparation of the slab prior to a wood floor installation. If the information is not available, run a nail forcefully across the surface. If it leaves an indentation, it will be necessary to apply a sealer or a densifier that is compatible with the adhesive being used. Check with the adhesive manufacturer for what to use in this situation.
- B. Normal weight concrete subfloors are designed and constructed with concrete mixtures with compressive strengths between 3,000 psi and 4,000 psi. A 3,000 psi compressive strength is the minimum requirement for most standard wood floor installations, including glue-down wood floors, or glued/mechanically anchored subfloors.
 1. The compressive strength of concrete can be tested according to ASTM C39.
 2. The compressive strength of hydraulic cement mortars can be tested according to ASTM C109/C109M.
 3. The compressive strength of gypsum can be tested in accordance with ASTM C472.
 4. In all cases, a downward force is applied to the cast, or cored specimen, until it breaks.
- C. Lightweight concrete is a lower-density concrete comprised of lightweight aggregate (such as pumice, clay, shale, foamed slag, and sintered pulverized), or has been aerated producing a lightweight cellular material. It is less dense than normal weight concrete. Lightweight concrete is most often used as a subflooring material where a lighter weight on a building's structural load is necessary, as a part of a larger sound-control subflooring system, where higher insulating is required, and/or in conjunction with many radiant heating systems.
 1. For glue-down applications, check with the adhesive manufacturer for applicable installation methods over lightweight concrete subfloors.
 2. Lightweight concrete must be prepared differently than normal weight concrete, and requires additional preparation, such as application of surface densifiers or hardeners properly applied prior to installation of wood flooring.
 3. The aggregate used in lightweight concrete is pre-saturated with water, which is not included in the w/c. Because of this, lightweight concrete can take longer than normal weight concrete to dry.

4. ASTM F2170 is an approved and recognized testing method for lightweight concrete. Electronic moisture meters, used in accordance with ASTM F2659, can be used to quickly assess the surface moisture of a concrete subfloor, but are not to be used for a go-no-go determination. ASTM has specifically disallowed ASTM F1869 for testing lightweight concrete.

PART V

Subfloor Toppings



There are several types of materials used to level or smooth a concrete subfloor. They include proprietary blends of compounds based on Portland cement, gypsum, and calcium aluminates.

- A. Follow the adhesive manufacturer requirements for compatibility and use of subfloor toppings.
- B. These subfloor toppings are commonly used for these purposes:
 1. Fire rating requirements.
 2. Where the existing substrate will not provide adequate performance standards.
 3. Floor flattening or leveling.
 4. Where a lighter weight on a building's structural load is necessary and normal weight concrete is not an option.
 5. As a part of a larger sound control subflooring system.
 6. Where higher insulating is required.
 7. In conjunction with many radiant heating systems.
- C. Properly mixed subfloor toppings should have a minimum compressive strength of 3,000 psi when tested in accordance with ASTM test method C109/C109M, C472, or C349, whichever is appropriate, for most standard wood floor installations, including glue down wood floors, or glued/mechanically anchored subfloors.

- D. Identify existing subfloor toppings that may not be suitable for wood floor installation. Typical characteristics of a subfloor topping that may be inadequate include: surface softness, chalkiness, cracks, surface deformation or irregularities, and loose gypsum that is no longer secured to the plywood or OSB subfloor. Repair options include any or all of the following:
 1. Remove damaged/loose subfloor topping and any loose debris.
 2. Replace damaged areas with manufacturer-recommended patches.
 3. Allow ample dry-time.
 4. Apply a manufacturer-recommended primer or densifier (multiple coats if necessary).
- E. Prior to any wood floor installation over gypsum-based underlayment material, the substrate must be completely dry. Once dried, it is often necessary to apply a sealer and/or a densifier/hardener that is compatible with the adhesive being used, in order to provide moisture protection and reduce cracking and degradation caused by natural movement.
- F. Dry-times of subfloor toppings vary from product to product, and manufacturer to manufacturer. Check with the manufacturer for dry times and moisture testing requirements.
- G. There is no recognized moisture testing method for gypsum-based underlayments. Most manufacturers recommend using either a specifically designated pinless meter, a pin-type meter, or following ASTM F2170. Follow the gypsum-based underlayment manufacturer's moisture testing instructions to determine when it has adequately dried.
- H. It is important to know when a gypsum-based topping is being used over concrete. The concrete subfloor must be at an acceptable level of dryness for the wood flooring and the surface of the concrete must be properly prepared and primed with the gypsum manufacturer's specified primer.
- I. Fiber-reinforced gypsum underlayments, fiber cement board, and cementitious backerboard are not suitable materials to be used below a wood flooring installation.

PART VI Integrity

There are several types of materials used to level or smooth a concrete subfloor. They include proprietary blends of compounds based on Portland cement, gypsum, and calcium aluminates.

- A. All substrates must be sound. Check for hollow spots, voids, loose or crumbling areas, and stress cracks.
- B. Do not install flooring over any issues without first addressing them with the builder, concrete contractor, architect, homeowner, or any other responsible party, prior to preparing the subfloor for new flooring. Many stress cracks, hollow spots, or crumbling areas may be an indication of structural issues, geographic soil conditions, or poor quality concrete that should be addressed by a professional.
- C. Stress cracks in concrete slabs should be addressed with crack isolation membranes, or in conjunction with the adhesive manufacturer's suggested system. Any crack isolation membrane must be compatible with the sealers and adhesives being used. Some adhesives and underlayment materials are designed to have crack-isolating properties.
- D. Follow the adhesive and underlayment manufacturers' recommendations to address stress cracks.
- E. Document the integrity of the slab by taking photographs and notes in the Jobsite Checklist.

PART VII Concrete pH

- A. pH is a measure of hydrogen ion concentration, a measure of acidity or alkalinity in a solution. The pH scale runs from 0 to 14; where 7 is neutral. Below 7 is considered acidic and above 7 is alkaline.

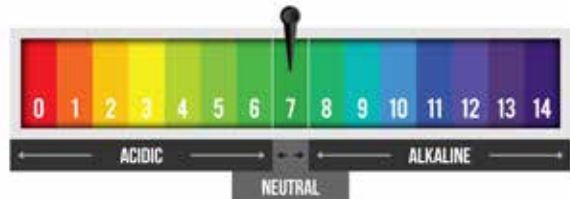

- B. The pH of a new concrete slab typically measures between 12 and 13. However, over time, as the surface of the slab reacts with carbon dioxide in the air, the pH of the surface

is gradually reduced to about 8.5. The process is referred to as carbonation.

- C. Follow the adhesive manufacturer's instructions on pH testing and acceptable results.
- D. When sufficient moisture is present in a slab to create a solution, the high pH solution that develops is capable of breaking down some types of wood flooring adhesives, and can lead to a flooring failure.
- E. The current method for measuring the pH level of a concrete slab surface is described in ASTM F710 (Standard Practice for Preparing Concrete Floors to Receive Resilient Flooring). Note: This procedure introduces an external source of liquid water that may not exist in the concrete, which can be misleading. It is far more important for the moisture levels in the subfloor to be at a level where solution chemistry will not develop, than it is to conduct a pre-installation pH test where liquid water from an external source has been introduced.
- F. Rinsing and vacuuming the surface of a concrete slab with potable water can lower the surface pH level. Doing so, however, cannot prevent the future development of a high pH condition at the surface of the slab if there is enough moisture in the slab to create a solution. Do not use acid rinses to "neutralize" a high-pH concrete surface. The acid will deposit unwanted salts and can attack interior building finishes and be detrimental to the final installation.

PART VIII Contaminates

- A. The slab must be free from any non-compatible contaminants or foreign materials such as sealers, curing compounds, waxes, oils, paint, dust, or drywall compounds, that might prevent adhesive bond as described in ASTM F710.
- B. Test for sealers, waxes, and contaminants by placing a drop of water on the concrete. If it beads-up, the concrete may contain a sealer or waxy substance.
- C. All contaminants must be properly removed from the surface. These contaminants can often be removed by using a concrete vacuum grinder, or by using a buffer/rotary sanding machine, equipped with special stripping discs or wire brushes. (Refer to the Health and Safety chapter for silica precautions.)
- D. Curing compounds are sometimes applied to the surface of a freshly finished concrete slab to retard the escape of moisture during the initial curing process. Curing compounds that remain on the slab surface may interfere with adhesion

of the wood flooring adhesives and should be removed.

- E. Cutback adhesive: Some previously manufactured asphaltic cutback adhesives contain asbestos. This material must be tested and properly removed by an asbestos remediation company. It is best to presume all cutback adhesive contains asbestos, until testing proves otherwise. (Refer to the Health and Safety chapter for more information.)

PART IX Porosity

- A. The ability of a concrete subfloor surface to readily absorb water is a key indicator in determining which types of adhesives, moisture control systems, primers, and self-leveling underlayments can be used in the installation process.



- B. Follow the adhesive manufacturer recommendations for porosity criteria.
- C. ASTM F3191 describes the procedure for assessing the substrate water absorption (often referred to as substrate porosity) of horizontal substrate surfaces prior to the installation of resilient floor coverings. The procedure involves applying a single drop of water to the surface of properly prepared substrate, and then determining whether that drop of water is absorbed within a given time period. Although this test method is specific to resilient floor coverings, many of the procedures included in this practice may be useful for assessing the substrate water absorption for substrates to receive wood flooring as well.
- D. Nonporous substrates such as densely machine-troweled concrete, mature and well-hydrated concrete, existing resilient flooring, terrazzo, and others, may require adjustments to the surface preparation method or product selection to ensure a successful installation. (See Concrete Surface Profile section.)
- E. Porous substrates, surfaces that are chalky or dusty, or have varying degrees of absorption may require a densifier/hardener that is compatible with the adhesive being used prior to wood floor installation.

PART X Concrete Surface Profile (CSP)

CSP is a standardized measure for the 'roughness' of a surface that is defined by the International Concrete Repair Institute (ICRI).

- A. CSP is the measure, under a cross-sectional view of the concrete surface, of the average distance from the peaks of the surface to the valleys. A very rough surface will have a high CSP number, such as CSP 10. A very smooth surface will be a CSP 1.
- B. The slab must meet minimum CSP requirements set forth by the adhesive manufacturer. Most manufacturers recommend a CSP of somewhere between CSP 1 and CSP 4. This typically can be found on the adhesive product technical data sheets (TDS).
- C. Adequate CSP can be achieved through a variety of methods including grinding, acid etching, needle scaling, abrasive blasting, shot-blasting, high and ultra-high pressure wet-jetting, and scarifying/shaving.

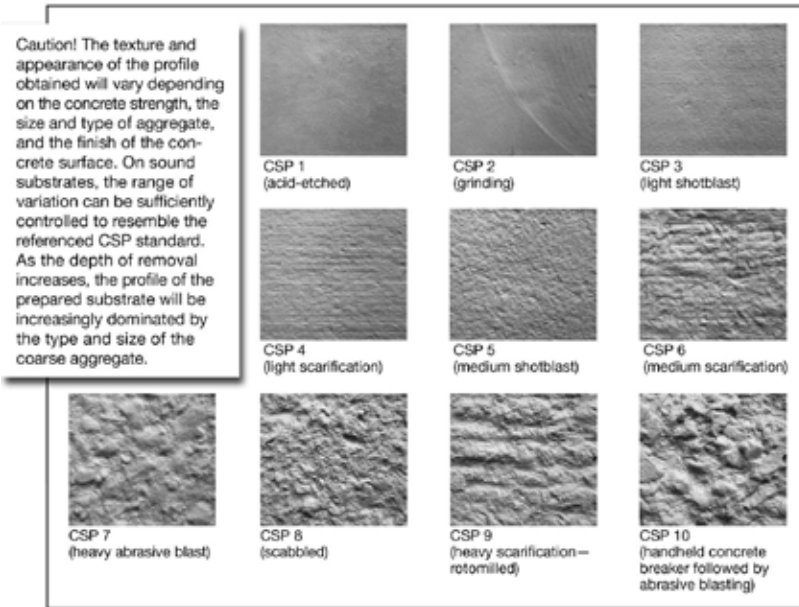

Surface preparation method	Concrete Surface Profile									
	CSP 1	CSP 2	CSP 3	CSP 4	CSP 5	CSP 6	CSP 7	CSP 8	CSP 9	CSP 10
Detergent scrubbing	█									
Low-pressure water cleaning	█									
Grinding	█	█								
Acid etching	█	█	█							
Needle scaling		█	█	█						
Abrasive blasting		█	█	█	█	█				
Shotblasting		█	█	█	█	█	█	█		
High- and ultra-high-pressure water jetting			█	█	█	█	█	█	█	█
Scarifying				█	█	█	█	█		
Surface retarder (1)					█	█	█	█	█	█
Rotomilling						█	█	█	█	█
Scabbling							█	█	█	█
Handheld concrete breaker								█	█	█

(1) Only suitable for freshly placed cementitious materials

PART XI Concrete Subfloor Flatness

- A. Subfloor flatness should be measured across the span of each individual room receiving wood flooring to get an overall perspective of the topography of the subfloor.
- B. Where one room meets another, the subfloor flatness should remain in tolerance. Where adjoining rooms are not within tolerance, are on a separate plane, or are abutting a ramp, a specialty or customized transition will be necessary.
- C. Measure subfloor flatness using a laser-level, string-line, or straight-edge by taking measurements across the plane of the line to determine tolerances.
 - 1. **Laser-level:** Place the laser level on the floor in the room receiving wood (ideally at the highest point of the subfloor). Lasers featuring a 360° static or rotating beam that allows you to take measurements from the subfloor to the plane of the laser at any given point within the room should be employed. Measure the deviations in the subfloor by using a tape measure, taper gauge, feeler gauge, depth finder, calipers, or the target provided by the laser manufacturer.



- 2. **String-line:** Place two blocks of wood (of the same thickness) at each end of the room, and then run a taught string-line across them. Take multiple measurements across the string-line between the blocks from the line to the subfloor. Measure the deviations in the subfloor by using a tape measure, taper gauge, feeler gauge, depth finder, or calipers. Move the blocks to multiple locations down each wall to cover the entire floor space.

- 3. **Straight-edge:** Place the straight edge across the substrate. Take multiple measurements across the straight-edge between the edge and the subfloor. Measure the deviations in the subfloor by using a tape measure, taper gauge, feeler gauge, depth finder, or calipers. Move the straight-edge to multiple locations, and rotate it 180° at each location to cover the entire floor space.
- D. From here, you should be able to mark out any discrepancies on the subfloor itself, giving a good indication of what alterations will be necessary. Document and photograph results.
- E. The floor does not need to be level in most situations, but should be flat. The slab should be flat to within minimum tolerance of 1/8" in 6', or 3/16" in 10', unless otherwise specified by the wood flooring manufacturer.
- F. If the slab is out of specification, it will need to be flattened. Flattening a concrete subfloor requires grinding high areas, filling low areas, or a combination of both. (Refer to the Health and Safety chapter for silica precautions.)



- G. Grinding high areas:
 - 1. Isolated high spots in concrete can be ground flat by using handheld angle grinders with a dust containment shroud attached to the tool when in use. A diamond cup wheel, or tungsten carbide or diamond disc wheel attachment normally works best for concrete removal.
 - 2. Larger areas of concrete subfloors that need to be flattened may require larger equipment such as walk-behind or riding grinders.



H. Filling low areas:

1. Prior to applying any patching compounds or self-levelers, the moisture conditions of the slab must be assessed through applicable moisture testing methods.
2. Use of approved patching compounds or self-levelers is normally recommended by the adhesive manufacturers to fill low areas in concrete subfloors.
3. Patching compounds and self-levelers containing polymer-based cement normally are recommended and must be compatible with the moisture control and adhesive systems.
4. Most patching compounds and self-levelers require a primer to be applied to the underlying substrate (dependent on the substrate) prior to application. Follow the manufacturer's instructions.
5. Each patching compound and self-leveler must be mixed and applied per the manufacturer's specific instructions. Thickness limitations, mixing instructions, application methods, dry times, and spread rates vary from product to product and from manufacturer to manufacturer. Follow the manufacturer's instructions.
6. Self-levelers and patches are normally applied by use of a gauge rake, a flat edge stainless steel trowel, smoothing trowels/spreaders, and other specialty tools as designated by the manufacturers of these products.



NOTICE: Disparity between concrete floor flatness tolerances and subfloor flatness tolerances designated for wood flooring at the time of installation. The following disparity has been adopted as detailed in the American Society of Concrete Contractors (ASCC) as published in "Concrete International, a publication of the American Concrete Institute (ACI)":

- A. Division 3 specifications for concrete floor flatness typically include floor flatness requirements. The specifications also require that floor tolerance measurements be taken in accordance with ASTM E 1155, "Standard Test Method for Determining Floor Flatness (FF) and Floor Levelness (FL) Numbers." Thus, the F-number measurements for meeting Division 3 requirements incorporate the following:
 1. Point elevations measured at regular 12" (300 mm) intervals along each line.
 2. Measurement lines distributed uniformly across the test section.
 3. Minimum # of readings required for statistical approach.
 4. Measurement lines not within 2' (.6 m) of any slab boundary, construction joint, isolation joint, block-out, penetration, or other similar discontinuity.
 5. Flatness measured within 72 hours of concrete placement.
- B. Division 9 specifications for concrete floors to receive a wood floor provide floor flatness requirements in terms of an allowable gap (1/8" in 6' or 3/16" in 10') under an unlevelled straightedge. There is no ASTM procedure for this measurement. Straightedge measurements for Division 9 incorporate the following:
 1. Continuous measurement at any gap under the straightedge.
 2. Indefinite number of straightedge locations on the floor.
 3. No minimum or maximum number of readings.
 4. Measurements typically taken with the straightedge crossing construction joints, or column blockouts, and near penetrations.
 5. Measurements made just prior to the installation of the floor, which can be between 4-18 months after concrete placement.
- C. These two tolerances are obviously not compatible, nor measured with the same specifications. And floor flatness changes with time (due to curling of the slab) which makes it impossible to predict flatness when flooring is ready to be installed. To further complicate the issue, concrete contractors seldom receive Division 9 specification requirements when bidding the job, nor are floor coverings normally selected at this time. Concrete contractors are responsible for meeting the requirements of Division 3.
- D. It is recommended by NWFA, American Society of Concrete Contractors (ASCC), National Tile Contractors Association (NTCA), The Flooring Contractors Association (FCICA), Tile Contractors Association of America (TCAA), International Masonry Institute (IMI), and International Union of Bricklayers and Allied Craftworkers (BAC), that the owner of the project provide a bid allowance, established by the architect/engineer and based on the flooring requirements, for any necessary grinding and patching to close the gap between Division 3 and Division 9 tolerances. Providing an allowance enables the owner to compare floor covering bids on an equal basis.

PART XII Moisture and Concrete

Concrete, whether used as a subfloor or as a building material, can introduce moisture to a structure. Excess moisture can pose problems for wood floors. An otherwise perfect flooring installation can fail if moisture is not addressed.

- A. The age of the slab does not coincide with the moisture levels present in the slab. A 50-year-old slab needs to be assessed the same as a newer slab.



- B. The point at which a wood floor can be installed over a concrete slab is dictated by the adhesive and flooring manufacturer requirements, and moisture testing results aligning with those requirements.
- C. The slab must be dry and meet the moisture condition requirements of the flooring and the adhesive manufacturers. Be certain to follow specific moisture testing protocol as defined in the applicable ASTM testing method. Document and photograph dates, jobsite conditions, and moisture readings. (Refer to the Moisture Testing chapter for details about moisture testing concrete subfloors.)
- D. There are three main sources of concrete moisture. They include water originating from the mix, water originating from above the slab, and water originating from below the slab.

1. Water originating from the mix



- a. Most slabs poured with the intention of being used for a residential or commercial interior substrate, are poured directly over a vapor retarding membrane. Assuming this membrane was installed properly, and remains completely intact, the moisture within the slab is the primary moisture that needs to be addressed.
- b. Under "ideal" conditions, that include concrete with a w/c of 0.50 or lower, a non-burnished concrete finish where a membrane-forming curing compound was not used, and favorable drying conditions surrounding the slab, it may take 30-45 days after placement before you can begin evaluating it for flooring (this does not indicate that any slab that is 30 days old is ready to receive flooring).
- c. Curing compounds inhibit the evaporation of moisture and will also extend the drying time dramatically.

2. Water from above the slab

- a. Concrete is a porous material. Once a dried concrete slab becomes wet, it takes time for this water to evaporate from the pores in the slab. The most common external source of moisture during new construction is precipitation, where the building is open to the elements.
- b. If the slab gets rewetted after starting to dry, the "drying clock" must be reset. Rewetting may include exposure to rainwater, power washing, leaks, or floods. The drying clock doesn't start until the slab has been protected from rewetting and the ambient conditions are conducive to drying. Studies have shown that due to the porous nature of all types of concrete, rewetting can greatly affect the dry time of the concrete slab.

c. Conditions in the space

- i. High RH conditions within the structure can affect the moisture levels within the slab.
- ii. Condensation on a slab occurs when the temperature of the slab allows the dew point to be reached, turning moisture from a vapor to a liquid.

- 3. **Water from below the slab:** There are three main ways moisture can find its way through a concrete slab. They include hydrostatic pressure, capillary action, and vapor diffusion. Other sub-slab sources may include broken pipe leaks from below or embedded within the slab, landscape irrigation, and breached or degraded vapor retarders.



a. **Hydrostatic pressure:** Fluid pressure that develops when the elevation of groundwater rises above the bottom elevation of the slab. Except in flood conditions, hydrostatic pressure only develops in “below-grade” applications. Moisture issues related to hydrostatic pressure can be avoided by using adequate drainage systems and/or waterproofing membranes around the foundation of the structure. This situation rarely occurs in the field.



b. **Capillary action:** The ability of liquid water to rise above the water table when the soil structure beneath the building is conducive to such rise. Through the forces of adhesion and cohesion liquid water has the ability to climb upward, against gravity, through soil structures where the gap between the soil particles is extremely small. An example of capillary action is the “wicking” up of water into a paper towel. To protect against the rise of liquid water by

capillary action, the design team will specify removal of the finer soil beneath the slab to a specified depth and require replacement of that material with a very coarse fill material or crushed stone where the gap between particles is widened and capillary rise is broken.

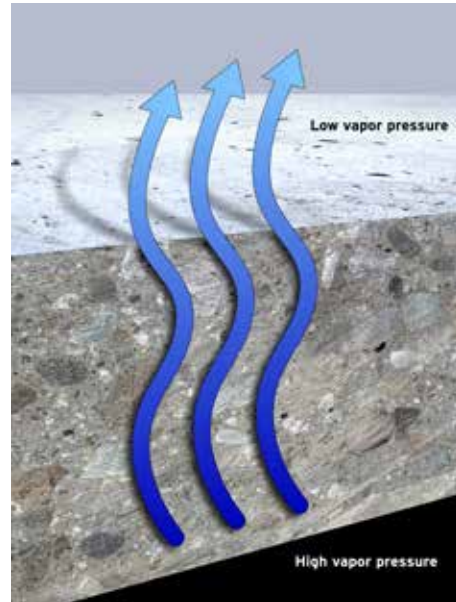

c. **Vapor diffusion:** The movement of water vapor through a vapor-permeable material from an area of higher concentration to an area of lower concentration. When the moisture level in one area is higher in concentration than another, moisture will diffuse to the area of lower concentration until a state of equilibrium is reached. The relative humidity below a slab-on-ground, regardless of the depth of the water table, will typically be 100 percent. The higher vapor pressure below the slab will naturally find its way to the area above the concrete, which will have a lower vapor pressure. This natural movement of water in vapor form can create an environment that can lead to a flooring failure. An intact Class I vapor retarder that conforms to the requirements of ASTM E1745 installed directly below the slab can minimize or alleviate these issues.

SUBSTRATES: Wood Subfloor Systems Over Concrete

In many situations, the installation method calls for an installation of a wood subfloor over a concrete subfloor. Different methods may be necessary depending on the subfloor system, the region you're in, and/or the flooring being installed. Always follow the flooring manufacturer's recommendations for adequate and recommended subfloor requirements below their flooring.

PART I Concrete Substrate Requirements

- A. The concrete slab should be flat, prior to installation of any wood panel system, to within 1/8" in 6' or 3/16" in 10', as detailed in the Concrete Subfloors chapter.
- B. The concrete slab should meet all moisture requirements as defined in the Moisture in Concrete chapter, and tested as detailed in the Moisture Testing chapter.
- C. For glue-down or mechanically anchored panels over concrete, the compressive strength of the slab should be a minimum of 3,000 psi.
- D. The concrete slab should meet all other requirements as detailed in the Concrete Subfloors chapter.

PART II Wood Panel Requirements

- A. Before installing any wood panel materials over concrete, the panels must be properly acclimated to a moisture content that coincides with the wood flooring and the facility in which they are being installed. (Refer to the Acclimation/Conditioning chapter for more detail.)

- B. The wood subfloor panels used in these installation methods should be suitable for use as subflooring material for the wood flooring being installed over them as detailed in the Wood Subfloor chapter.
- C. Do not use pressure-treated plywood unless it has been kiln-dried after treatment (KDAT), and has been acclimated to a moisture content that coincides with the wood flooring and the facility in which it is being installed.
- D. The wood panels installed over a concrete slab must meet all other requirements as detailed in the Wood Subfloors chapter.

PART III Wood Subfloor Systems

- A. Install a Class 1 impermeable vapor retarder over the slab when calcium chloride readings are greater than 3 pounds, relative humidity readings are greater than 80%, or calcium carbide readings are greater than 2.5%. In on- and below-grade applications, due to the ever-changing moisture variability with a concrete slab, and the likelihood of sub-slab moisture barrier degradation over time, a Class I impermeable vapor retarder is always recommended.

B. Double-Layer Subfloor (floated)

1. For double-layer floors (one subfloor layer and a second (top) layer of underlayment), panels should be plywood or oriented strand board (OSB), Exposure 1, manufactured according to U.S. Product Standard PS 1 or PS 2, or Canadian standard CSA O121, O151, O325, or O437.
2. Use minimum 11/32 (9.5mm) subfloor panels in 4'x8' sheets for both layers.
3. Both layers of subfloor panels should be properly acclimated in the area where they will be installed as noted in the Subfloor Moisture section of the Wood Subfloors chapter.
4. Place the first subfloor panel layer with edges parallel to the wall, without fastening.
5. The second layer should be laid on a diagonal or offset by a minimum 4" in each direction to the base layer. No base layer seams should align with the top layer seams.
6. Both layers of the subfloor panels should be placed with 1/16"-1/8" gaps between abutting panels on all four sides and 3/4" minimum expansion space at all vertical obstructions.
7. The second layer of panels should be fastened at a minimum of 6" O.C. along all panel edges and 12" O.C. grid pattern through the field. Use only ring- or screw-shanked nails, proprietary screws, or equivalent fasteners. Application of an elastomeric wood floor adhesive to adjoin the two panels together may not be recommended by the subfloor panel manufacturer. Follow manufacturer instructions.
8. When nailing down a wood floor, consider the overall subfloor thickness when selecting flooring fastener length to avoid penetrating through the subfloor system and the vapor retarding membrane below.

WOOD SUBFLOOR OVER CONCRETE: FLOATED DOUBLE LAYER

NOTE:
FIRST LAYER OF MINIMUM 1 1/32" PANELS.

SECOND LAYER OF MINIMUM 1 1/32" PANELS, MAY BE LAID ON DIAGONAL OR OFFSET BY MINIMUM 4" IN EACH DIRECTION TO THE BASE LAYER. NO BASE LAYER SEAMS SHOULD ALIGN WITH THE TOP LAYER SEAMS, AND SPACED 1/8" ON ALL SIDES OF ABUTTING PANELS, WITH 3/4" MINIMUM EXPANSION SPACE AT ALL VERTICAL OBSTRUCTIONS.

THE SECOND LAYER PANELS SHOULD BE FASTENED WITH RING OR SCREW SHANKED NAILS, PROPRIETARY SCREWS, OR EQUIVALENT, WITH ATTACHMENT ONLY THROUGH THE ENTIRE SUBFLOOR PANEL, BUT NOT PENETRATING THROUGH THE CLASS I VAPOR RETARDER.

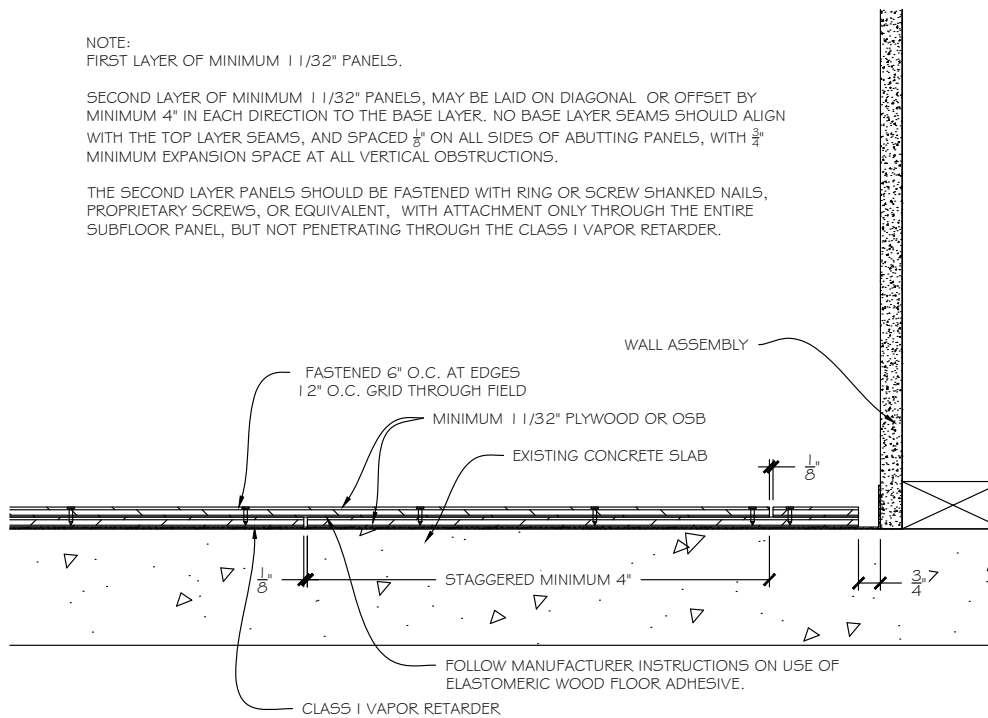

C. Single-Layer Subfloor

1. For single-layer subfloors, panels should be of plywood or oriented strand board (OSB), Exposure 1, manufactured according to U.S. Product Standard PS1 or PS2, or Canadian standard CSA 0121, 0151, 0325, or 0437.

2. Use minimum 23/32 (17.8mm) subfloor panels, cut into approximately 2'x8' or 4'x4' panels.

3. Kerf the subfloor panels on the back 3/8" deep, on a 12"x12" grid across the width of the panels.



D. Glue-Down Subfloor

1. Always follow the adhesive manufacturer's recommendation for moisture requirements and limitations, compatible moisture control systems, application method, trowel notch type, and spread rates.
2. Install a Class 1 impermeable vapor retarder over the slab when calcium chloride readings are greater than 3 pounds, relative humidity readings are greater than 80%, or calcium carbide readings are greater than 2.5%. In on- and below-grade applications, due to the ever-changing moisture variability with a concrete slab, and the likelihood of sub-slab moisture barrier degradation over time, a Class I impermeable vapor retarder is always recommended.
3. With 2'x8' panels, the panel's long-axis should be oriented perpendicular to, or diagonally to, the direction of the flooring installation.
4. Panels should be staggered every 2' in the adhesive, and spaced 1/8" on all four sides of abutting panels, and 3/4" minimum expansion space at all vertical obstructions.
5. When nailing down a wood floor, consider the overall subfloor thickness when selecting flooring fastener length to avoid penetrating through the subfloor system and the vapor retarding membrane below.

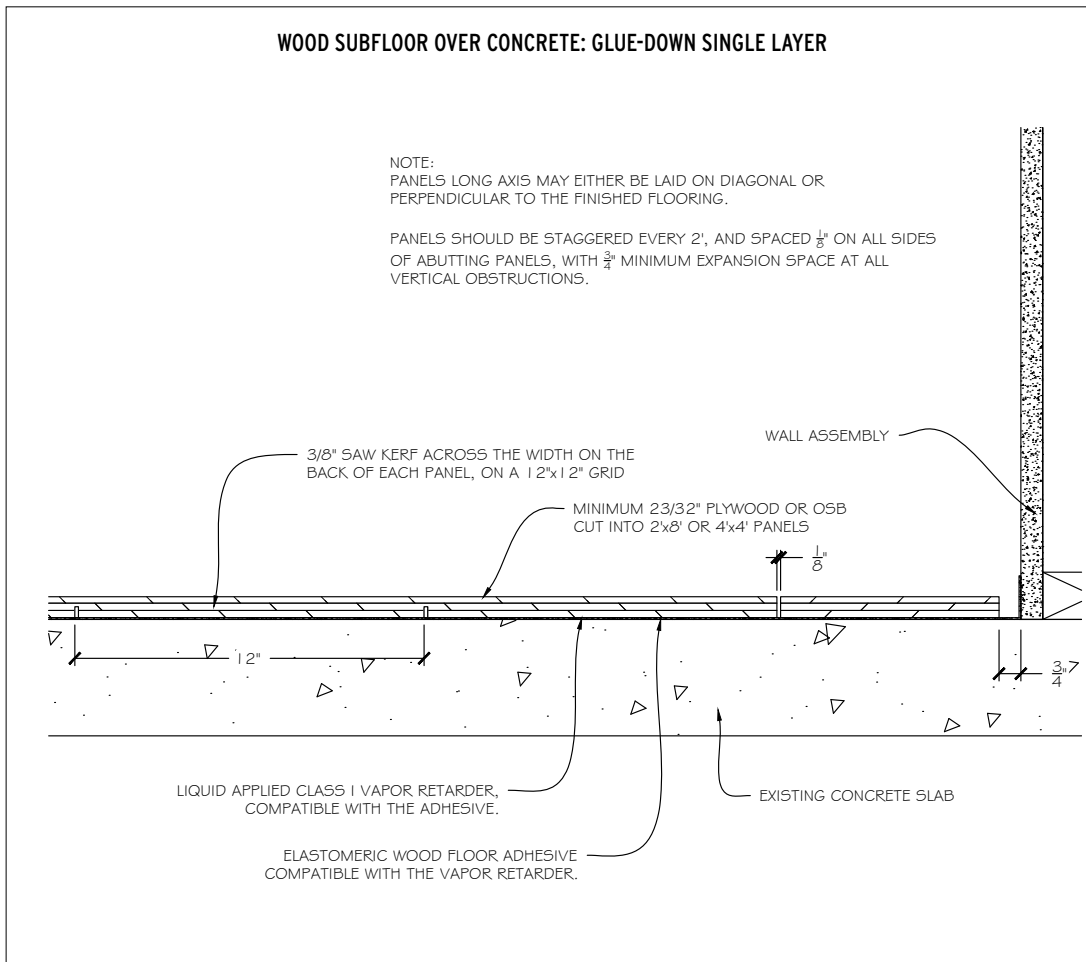

E. Mechanically Anchored Subfloor

1. A Class I impermeable vapor retarder is always recommended below the wood subfloor.
2. In on-grade and below-grade slabs, where subsurface may be a concern, the use of mechanical anchors that penetrate the vapor retarder can allow moisture a path into the wood subfloor system. Always use the vapor retarder manufacturer's sealing mastic at locations where mechanical anchors will penetrate the vapor retarder.
3. Use minimum 23/32 (18.3mm) subfloor panels in full 4'x8' sheets, or cut into 2'x8' or 4'x4' sections.
4. The panel's long-axis should be oriented perpendicular to, or diagonally to, the direction of the flooring installation.
5. Place panels in a staggered joint pattern, with 1/8" spacing between sheets, and 3/4" minimum expansion space at walls and all vertical obstructions.
6. Panels should be mechanically anchored. The anchors may be powder-driven pins, pneumatic driven nails, screws, deformed pins, or other fasteners suitable for concrete application. Check with the fastener manufacturer for specification such as length, drill size, shot load, and anchoring/fastener schedule requirements where applicable.
7. When nailing down a wood floor, consider the overall subfloor thickness when selecting flooring fastener length to avoid penetrating through the subfloor system and the vapor retarder below.

WOOD SUBFLOOR OVER CONCRETE: MECHANICALLY ANCHORED SINGLE LAYER

NOTE:
PANELS LONG AXIS MAY EITHER BE LAID ON DIAGONAL OR PERPENDICULAR TO THE FINISHED FLOORING.

PANELS SHOULD BE STAGGERED EVERY 2', AND SPACED 1/8" ON ALL SIDES OF ABUTTING PANELS, WITH 3/4" MINIMUM EXPANSION SPACE AT ALL VERTICAL OBSTRUCTIONS.

THE FASTENERS MAY BE POWDER-DRIVEN PINS, PNEUMATIC DRIVEN NAILS, SCREWS, DEFORMED PINS, OR OTHER FASTENERS SUITABLE FOR CONCRETE APPLICATION.

CHECK WITH FASTENER MANUFACTURES SPECIFICATIONS FOR LENGTH, DRILL SIZE, SHOT LOAD AND ANCHORING/FASTENER SCHEDULE REQUIREMENTS.

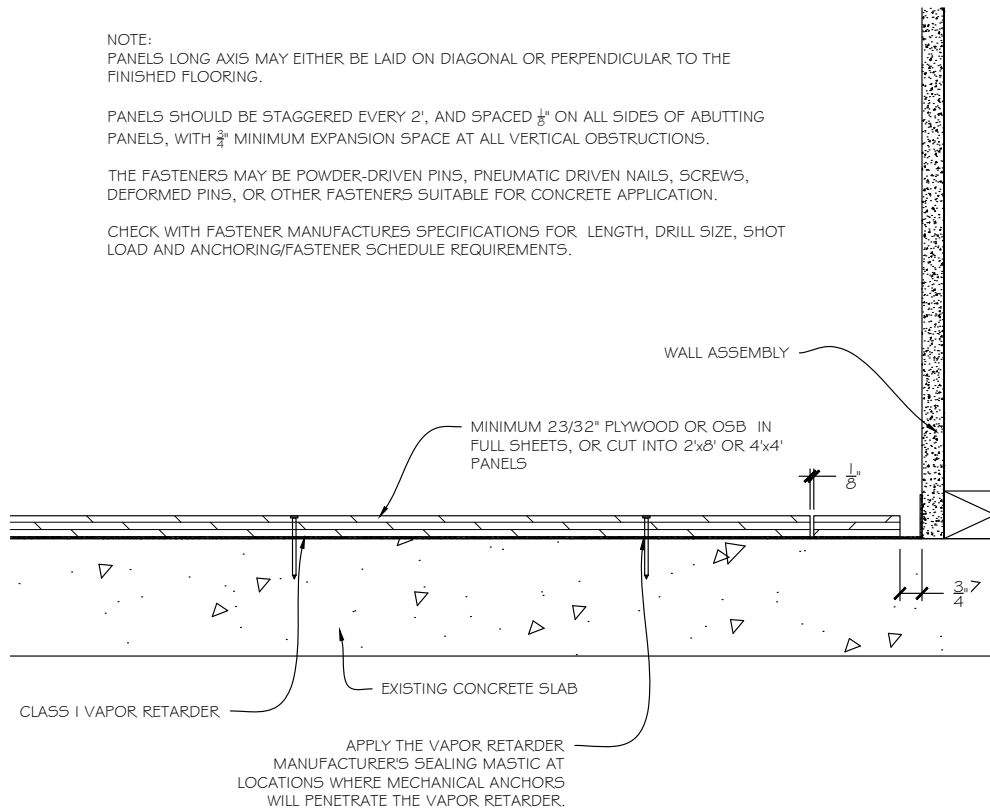

SUBSTRATES: Screeds/Sleepers

Screeds (also known as sleepers) are dimensional lumber boards that are laid over, or embedded in, a substrate. They are laid perpendicular to the finished floor, either laid on-end or laid flat-side-down, providing a nailing surface for the wood flooring.

PART I

Screeds/Sleepers (laid on-end)

A. Materials

1. Screeed/sleeper material laid on-end is typically 2"x4" (50mm x 100mm) lumber made of pine, Douglas fir, or other framing lumber.
2. Screeed/sleeper material must be kiln-dried. If using pressure-treated material, only use KDAT (kiln-dried after treatment) material.
3. Screeed/sleeper material should be conditioned to the expected in-use conditions and the moisture content should coincide with the temperature and humidity (EMC) requirements of the flooring being installed over them.

B. Screeed/sleeper Installation Requirements:

1. Moisture test and prepare the substrate according to the type of substrate the screeds/sleepers are being installed over, per the applicable chapter in these guidelines.
2. Installation of an appropriate vapor retarder is necessary over the substrate and below the screeds/sleepers. Refer to the Underlayments-Moisture Control chapter for detail related to the appropriate substrate.

3. Screeds/sleepers should be laid perpendicular to the direction of the flooring, and parallel to one another.
4. For nail-down installation, screeds/sleeper spacing should be laid out no more than 8" O.C., to accommodate most ¾" flooring installation fastener schedule requirements. When embedded screeds/sleepers are spaced wider than 8", the wood floor installation must be installed in full-spread adhesive, nail-assisted glue-down, floating, or with a wood panel subfloor system installed over the screeds/sleepers.
5. The channels between the screeds/sleepers should be filled with concrete, a lightweight concrete mix, or a gypsum-based topping compound that meet the minimum requirements as detailed in the Concrete Subfloors chapter.
6. The compound should be poured even with the top of the screeds/sleepers. The introduction of water from the mix will introduce moisture to the screeds/sleepers, and may cause them to become distorted and swell.

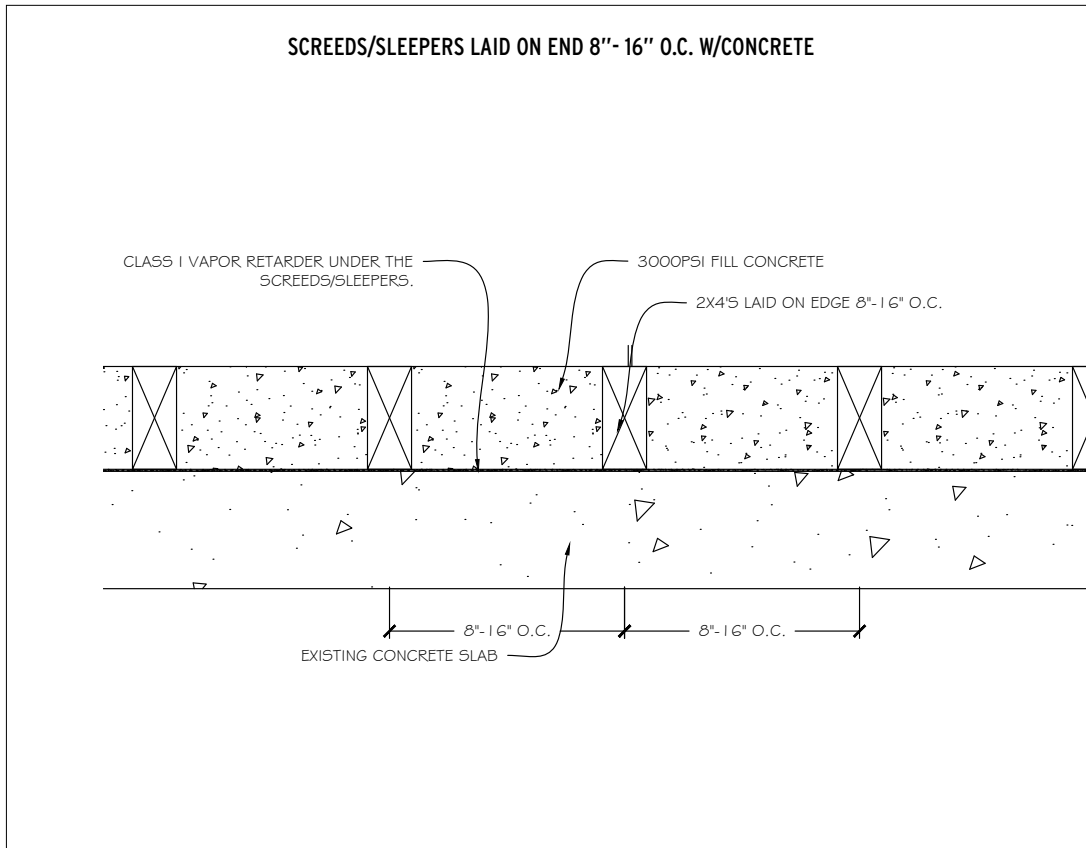

7. Moisture:

- a. Dry-times of subfloor toppings vary from product to product, and manufacturer to manufacturer. The retention of moisture with most lightweight concrete aggregate mixtures adds significant time to the drying process. Check with the manufacturer for dry times and moisture testing requirements.
- b. A minimum of 20 areas per 1,000 square feet of subflooring should be moisture tested. Testing locations should be representative of the entire project and include a minimum of three tests per room. Elevated readings should be addressed prior to delivery and installation of any wood flooring.
- c. The moisture content of any screed/sleeper material should be no more than 2% MC difference from plank flooring ($\geq 3"$ widths) and no more than 4% difference from strip flooring ($< 3"$ widths). Check and record the moisture of the screeds/sleepers using a wood moisture meter set to the appropriate species setting for the wood being tested. Take readings at multiple depths to ensure all moisture has dissipated.

PART II

Screeds/Sleepers (laid flat)



A. Materials:

1. Screed/sleeper material laid flat is typically 2"x4" or 1"x4" lumber made of pine, Douglas fir, or high-performance 23/32 OSB or plywood ripped to 3½" widths.
2. Screed/sleeper material must be kiln-dried. If using pressure-treated material, only use material that has been kiln-dried after treatment (KDAT).

3. Screed/sleeper material should be conditioned to the expected in-use conditions and should coincide with the temperature and humidity (EMC) requirements of the flooring being installed over them.
4. When screeds/sleepers are laid flat, they should be cut to approximately 24" lengths.

B. Installation Requirements:

1. Moisture test and prepare the substrate according to the type of substrate the screeds/sleepers are being installed over, per the applicable chapter in these guidelines.
2. Screeds/sleepers should be adhered to the concrete subfloor perpendicular to the direction of the flooring, and parallel to one another.
3. Apply a Class I liquid-applied vapor retarder that is compatible with the adhesive being used.
4. Adhere the screeds/sleepers to the concrete subfloor. Use an elastomeric wood floor adhesive or hot-tar specifically formulated for wood flooring installations, both of which allow for movement within the flooring system. Follow the adhesive manufacturer's recommendation for moisture requirements, and moisture limitations, compatible moisture control systems, application method, and spread rates.

5. For ¾" flooring up to 3¼" widths, screeds/sleepers should be placed an average of 3½" apart, to provide approximately 50% coverage of the subfloor.
6. For ¾" flooring >3¼" up to 5" in width, screeds/sleepers should be placed an average of 1" apart, to provide approximately 90% coverage of the subfloor.
7. Do not install wide plank wood flooring (>5") directly over screeds/sleepers laid flat. Wide plank flooring will require a minimum 23/32 wood panel subfloor to be installed over the screeds/sleepers.
8. Screed/sleepers joints should be staggered, which is easily accomplished by alternating full and half pieces on the starter wall.
9. Leave a minimum of ¾" expansion space at all vertical obstructions.
10. The moisture content of any screed/sleeper material should be no more than 2% MC difference from plank flooring (≥3" widths) and no more than 4% difference from strip flooring (<3" widths). Check the moisture of the screeds/sleepers using a wood moisture meter set to the appropriate species setting for the wood being tested. Take readings at multiple depths to ensure all moisture has dissipated.

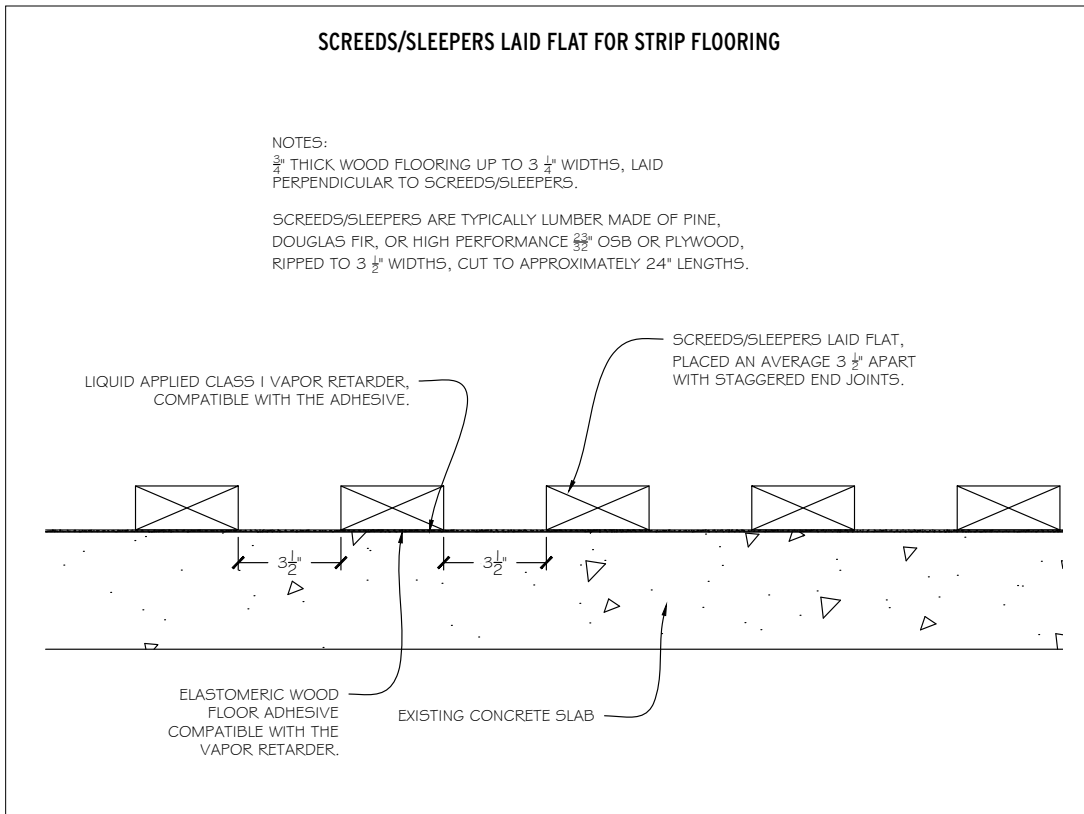

SCREEDS/SLEEPERS LAID FLAT FOR PLANK FLOORING

NOTES:

$\frac{3}{4}$ " WOOD FLOORING FROM $>3\frac{1}{4}$ " UP TO 5" WIDTHS, LAID PERPENDICULAR TO SCREEDS/SLEEPERS.

SCREEDS/SLEEPERS ARE TYPICALLY LUMBER MADE OF PINE, DOUGLAS FIR, OR HIGH PERFORMANCE $\frac{3}{32}$ " OSB OR PLYWOOD, RIPPED TO $3\frac{1}{2}$ " WIDTHS, CUT TO APPROXIMATELY 24" LENGTHS.

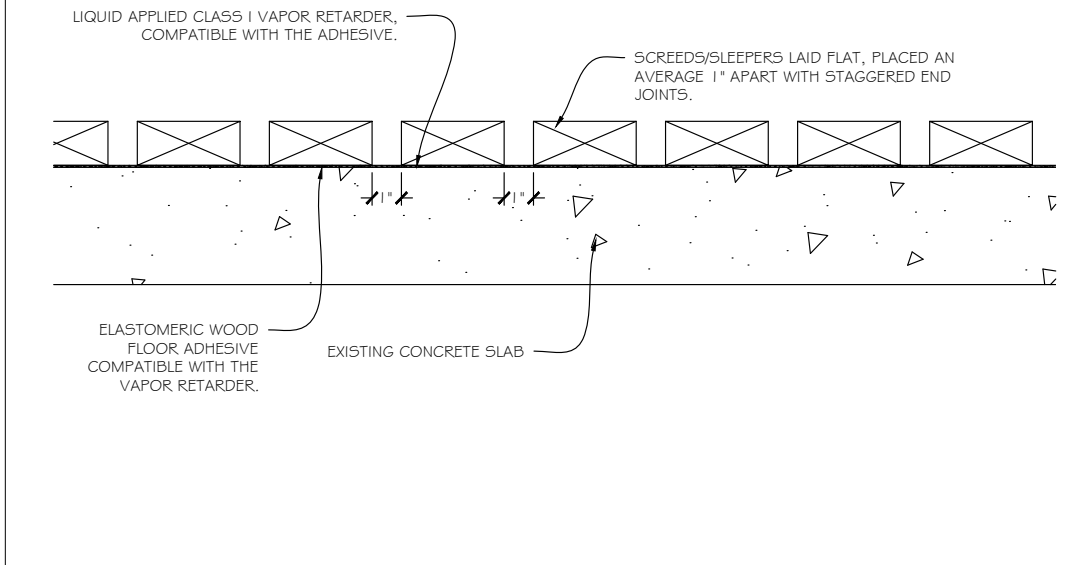

PART III Installation Methods over Screeds/Sleepers

A. Screed/Sleeper Flatness Requirements:

1. Check screeds for flatness with an 8-10' straight edge. All screeds should come into full contact with the straight edge.
2. Sand or plane the high areas of the screeds to achieve a flatness tolerance where the straight edge comes in to full contact with all screeds. Replace low screeds or shim the low areas of the screeds with a shimming material that will not affect the penetration of the flooring fastener into the screed.

- B. Only $\frac{3}{4}$ " solid or engineered tongue-and-groove wood flooring may be installed directly to screeds/sleepers.
- C. Only use floor board lengths that span two or more screeds/sleepers.
- D. If radiant heating tubes or elements are embedded within the concrete, the radiant heating system should be fully operational, turned on, and maintained at the normal and expected operating temperature, regardless of season, for a minimum of 5 days prior to delivery of wood flooring. Keeping the system on helps force out moisture from the concrete or compound mix. (Refer to the Radiant Heat chapter for more detailed information.)

E. Nail-Down Installations over Screeds/Sleepers:

1. When screeds/sleepers are spaced 8" O.C. or less, the nail-down installation method may be employed, as long as fastener placement coincides with fastener schedule requirements. (Refer to the Nail-Down Installation Methods chapter for more-detailed information.)
2. Blind-nail wood flooring to the screeds. Fastener length should not be less than 1½".
3. Fastener schedule over the screed/sleeper systems will be dictated by screed/sleeper placement and may not allow for adequate fastener schedules. The use of an elastomeric adhesive in conjunction with the mechanical fasteners is recommended any time the flooring fastener schedule will be compromised.
4. When nailing down a wood floor, consider the screed/sleeper placement in comparison to the angle of the fastener driving into it to avoid penetrating into any radiant heating tubes or elements.

F. Nail-Assisted Glue-Down Installation Methods over Screeds/Sleepers (laid on-end):

1. When screeds/sleepers are spaced greater than 8" O.C., and space between is filled with concrete, lightweight concrete mix or a gypsum-based topping, the nail-assisted glue-down installation method is required.
2. When using a flooring adhesive over a lightweight concrete mix or a gypsum-based topping compound, a sealer and/or densifier may be necessary. Follow the adhesive manufacturer's installation instructions based on the type of substrate being installed over.
3. The full-spread adhesive application should remain the same as normal installation for the flooring being installed. The addition of mechanical fasteners is not intended as a replacement fastening mechanism, rather a supplemental fastening method to the adhesive. It is best to blind-nail the flooring into the screeds/sleepers to hold the flooring in place while the adhesive sets-up.

4. This method may be appropriate where flooring needs to be driven tight during the installation.

G. Additional information about screed/sleeper systems used in gym floor applications can be found at www.maplefloor.org.

H. Engineered wood flooring less than ¾" thick, any solid or engineered wide plank floor (>5" widths), and solid thin-classification strip flooring (including ½") should not be installed directly to screeds/sleepers. These floors may be installed following the below method:

1. Overlay the screed/sleeper system with a minimum single layer of 23/32 plywood or high-performance OSB subfloor panels, acclimated to the expected live-in conditions of the facility (refer to the Wood Subfloors chapter for more detail).
2. Subfloor panels should be installed with the long panel dimension (strength axis) perpendicular to the screeds/sleepers and offset by minimum 4" from adjacent panels. Panels may also be laid on diagonal to the screeds/sleepers.
3. The ends of the panels should land near the center of the screeds/sleepers, with a minimum bearing of ½".
4. The panels should be fastened at a minimum of 12" O.C. along all panel edges and 12" O.C. along each screed/sleeper. Use only ring- or screw-shanked nails, proprietary screws, or equivalent fasteners. Fastener lengths should account for the total thickness of the wood paneling and screeds/sleepers, as to not puncture through the vapor retarder below. Application of an elastomeric wood floor adhesive can assist in fastening them in place.
5. Typical panel edge spacing requirements for floor joist/truss systems call for a 1/16" - 1/8" gap around the perimeter (all four sides) of each panel, as well as ¾" gap at all vertical obstructions.

SCREEDS/SLEEPERS LAID ON END W/CONCRETE W/WOOD PANEL OVERLAY

NOTES:
FASTENED ALONG ALL PANEL EDGES AND 12" O.C. ALONG EACH SCREED/SLEEPER THROUGH FIELD.

THE PANELS SHOULD BE FASTENED USING ONLY RING OR SCREW-SHANKED NAILS, PROPRIETARY SCREWS, OR EQUIVALENT FASTENERS.

OPTION: APPLICATION OF AN ELASTOMERIC WOOD FLOOR ADHESIVE CAN ASSIST IN FASTENING.

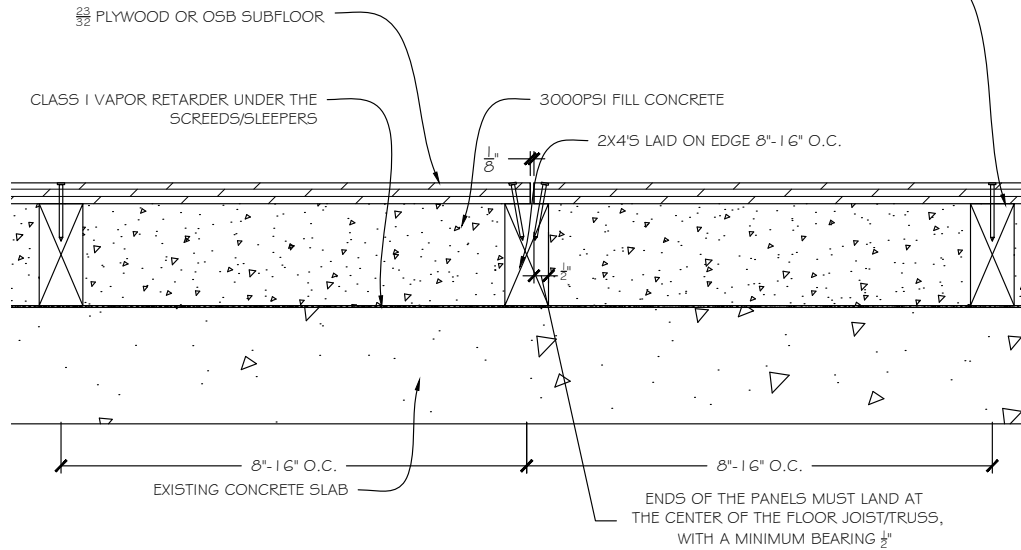

SCREEDS/SLEEPERS LAID FLAT FOR WOOD PANEL OVERLAY

NOTES:
SCREEDS/SLEEPERS ARE TYPICALLY LUMBER MADE OF PINE, DOUGLAS FIR, OR HIGH PERFORMANCE 3/4" OSB OR PLYWOOD, RIPPED TO 3 1/2" WIDTHS CUT TO APPROXIMATELY 24" LENGTHS.

3/4" PLYWOOD OR OSB WOOD PANELS LAID ON DIAGONAL, OR PERPENDICULAR TO SCREEDS/SLEEPERS, AND OFFSET FROM ADJACENT PANELS BY MINIMUM 4".

LIQUID APPLIED CLASS I VAPOR RETARDER, COMPATIBLE WITH THE ADHESIVE.

OPTION: APPLICATION OF AN ELASTOMERIC WOOD FLOOR ADHESIVE CAN ASSIST IN FASTENING SUBFLOOR TO SCREEDS/SLEEPERS.

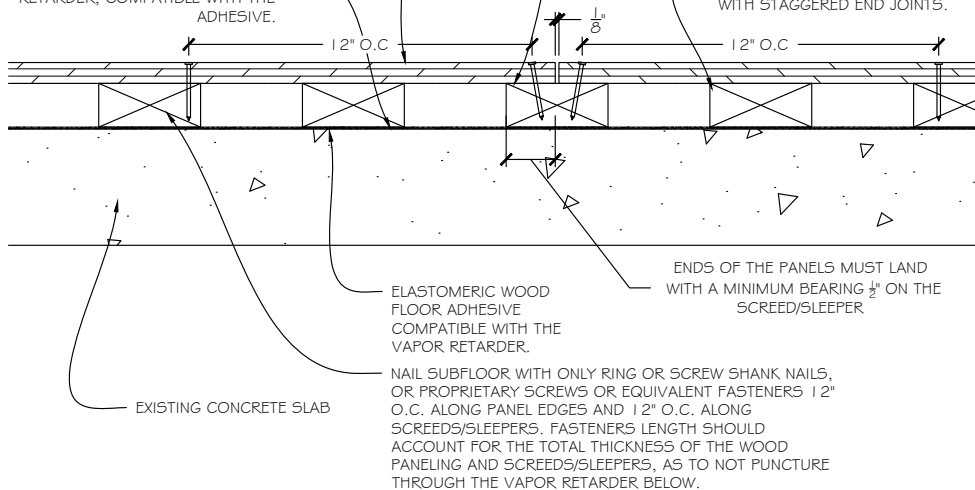

SUBSTRATES: Radiant Heat

Radiant (underfloor) heating is a type of heating system that is placed below the floor. Radiant heating as a technology is the method of intentionally using the principles of radiant heat to transfer radiant energy from an emitting heat source to an object. Radiant heating may be either hydronic (water/fluid flowing through pipes) or electric (electric resistance heating elements).

PART I Types of Radiant Heating Systems

There are many types of radiant heating systems available. The heating system must be approved and properly set up for each specific zone, and for each flooring type being installed over it. Check with the flooring manufacturer for approval, and the recommended installation method over the specific system that is in place. For more-detailed information on any of these systems, visit the Radiant Professionals Alliance (RPA) at www.radiantprofessionalsalliance.org.



A. **Hydronic Radiant Heating:** An underfloor heating or warming system that involves transfer of heat by circulating a fluid (such as water) in a closed system of pipes. Insulation is required below the heat source for most of these systems. Types of hydronic radiant heating systems include:

1. **Slab-on-Grade:** Radiant tubing is embedded in concrete. The tubing typically is attached to metal mesh with plastic ties. A 4" slab is most typical. The tubing is normally placed in the middle of the slab. Full under-slab insulation and moisture control is required for most residential applications. Slabs have a large thermal mass, which stabilizes temperature swings, but slows response.

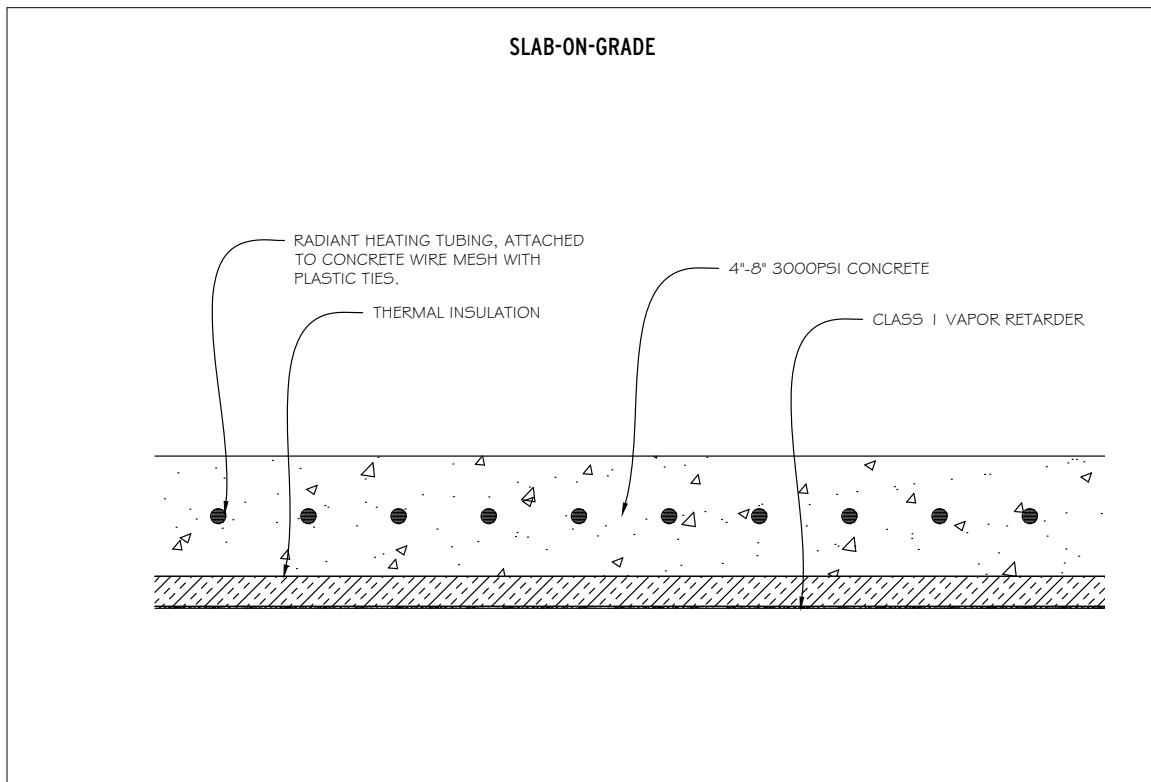

2. **Thin Slab on Subfloor:** Radiant tubing is attached on top of the wood subfloor with approved staples or plastic clips. A thin topping of self-leveler underlayments, trowelable underlayments, floor fills, or lightweight concrete is poured over the tubing. Typical slabs are a minimum of 1 1/2" thick (when using 1/2" tubing), but may be as thin as 1 1/4" thick (when using 3/8" tubing). The maximum thin slab thickness is 3". Gypsum concrete is lighter than cement, but a little less conductive.

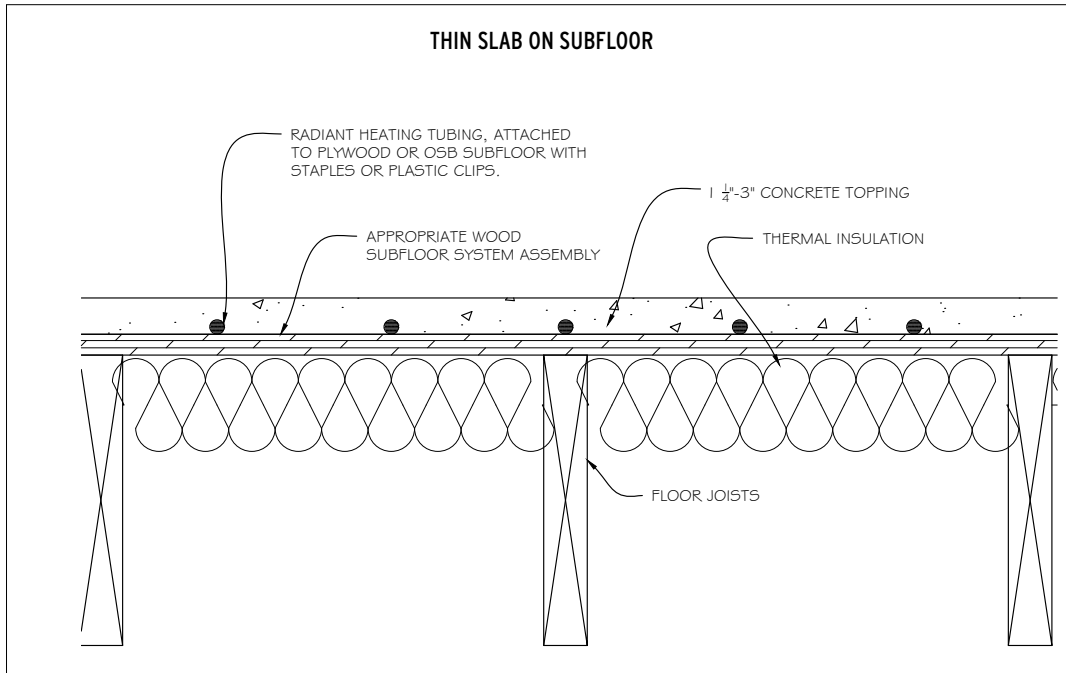

3. **Structural Radiant Subfloor with Aluminum Grooves:** Premanufactured 1 1/8" thick wood subfloor panels that have grooves for tubing and an aluminum sheet bonded to the panel. In this case, the premanufactured panels serve both as the structural subfloor and as the channel into which the tubing is installed. The aluminum sheet makes the system accelerate rapidly and spreads out the heat. Tubing normally is installed 12" on center in the grooves.

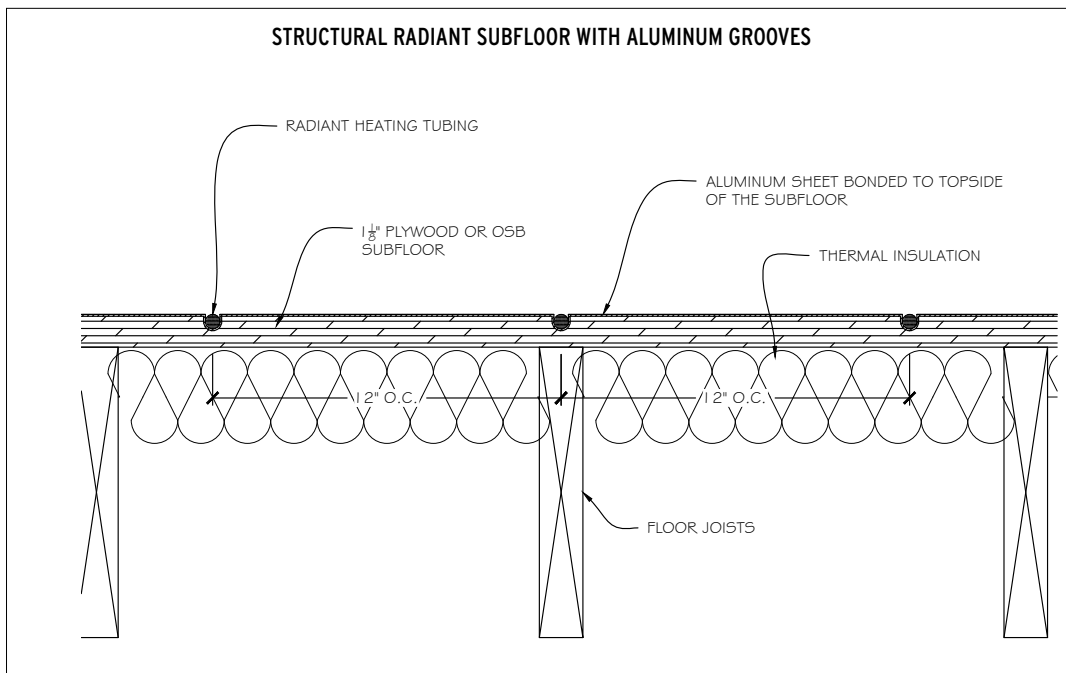

4. **Boards with Grooves and Metal, Attached to Top of Subfloor:** Several varieties currently exist. One board has metal on the bottom and another on the top. Both serve to spread the heat laterally. Normally, they are glued and screwed, or stapled, to the top of a wood subfloor panel. Under some conditions, they may be attached on top of existing slabs. Different products use different pipe sizes.

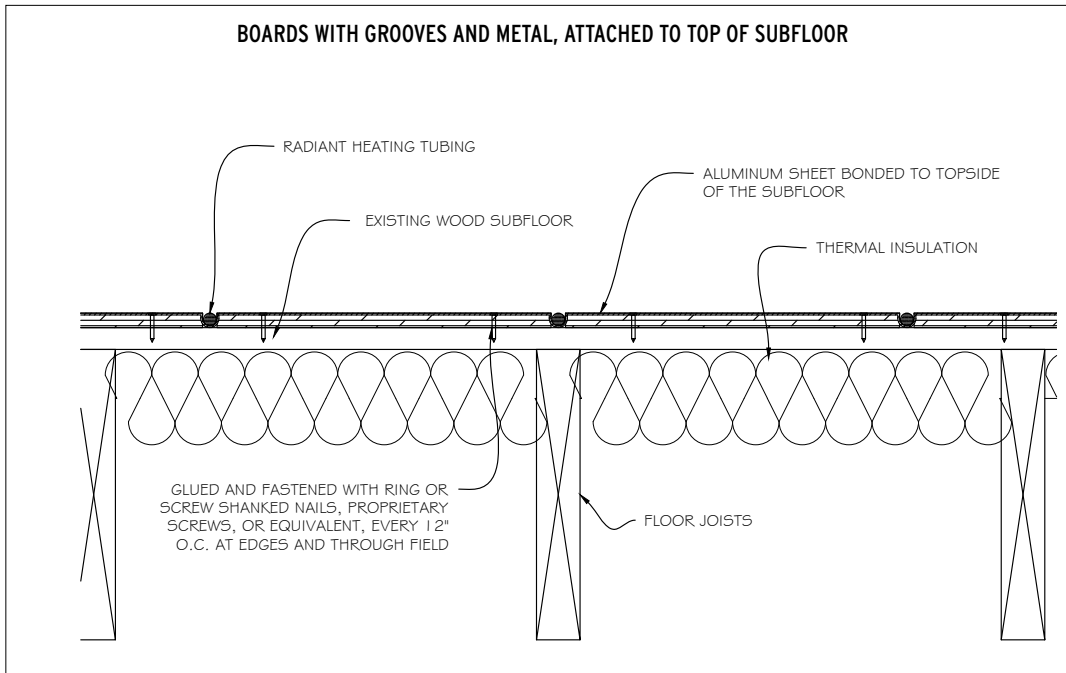

5. **Sandwich Method with or without Plates on Top of Subfloor:** Typically, 1"x4" screeds/sleepers are attached to the top of the subfloor, and pipe is laid between the screeds/sleepers with or without the addition of the metal plates. Metal plates typically cover about 80% of the outside diameter of the pipe, adding significantly to the even dispersion of heat.

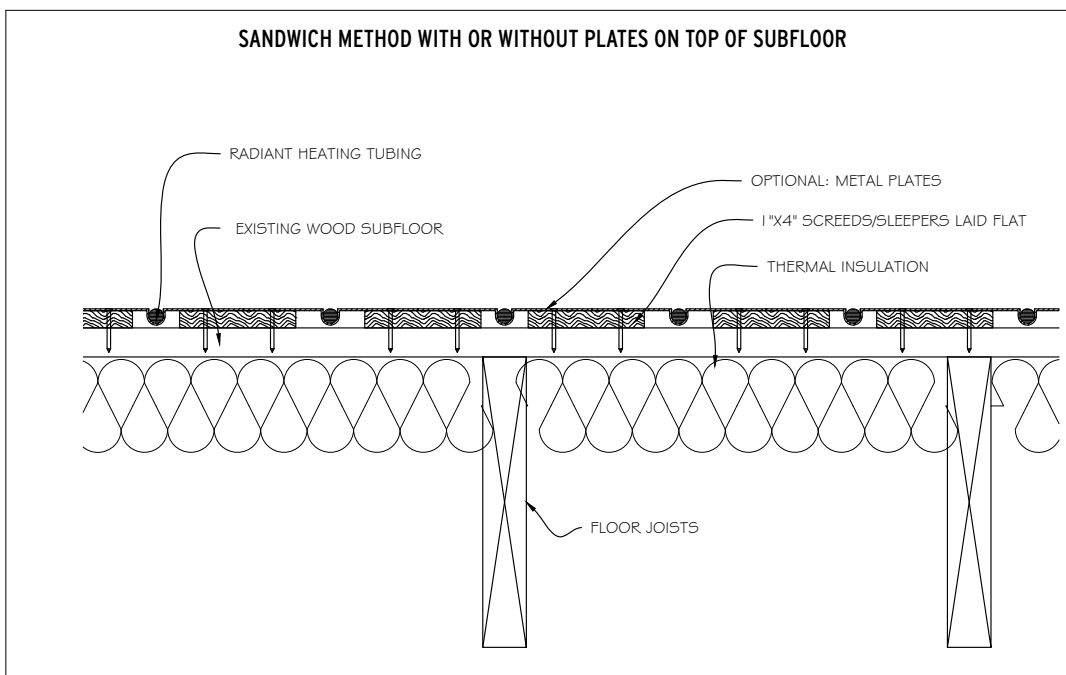

6. **Integrated Plate Panels:** The integrated plate panel system is designed to install over an existing subfloor. The $\frac{3}{4}$ " panels are pre-insulated and water-resistant. The use of $\frac{1}{2}$ " pipe allows for greater circuit lengths and is 100% covered by metal. The integrated plate panels are sandwiched between the wood subfloor and wood nailing surface for hardwood flooring.

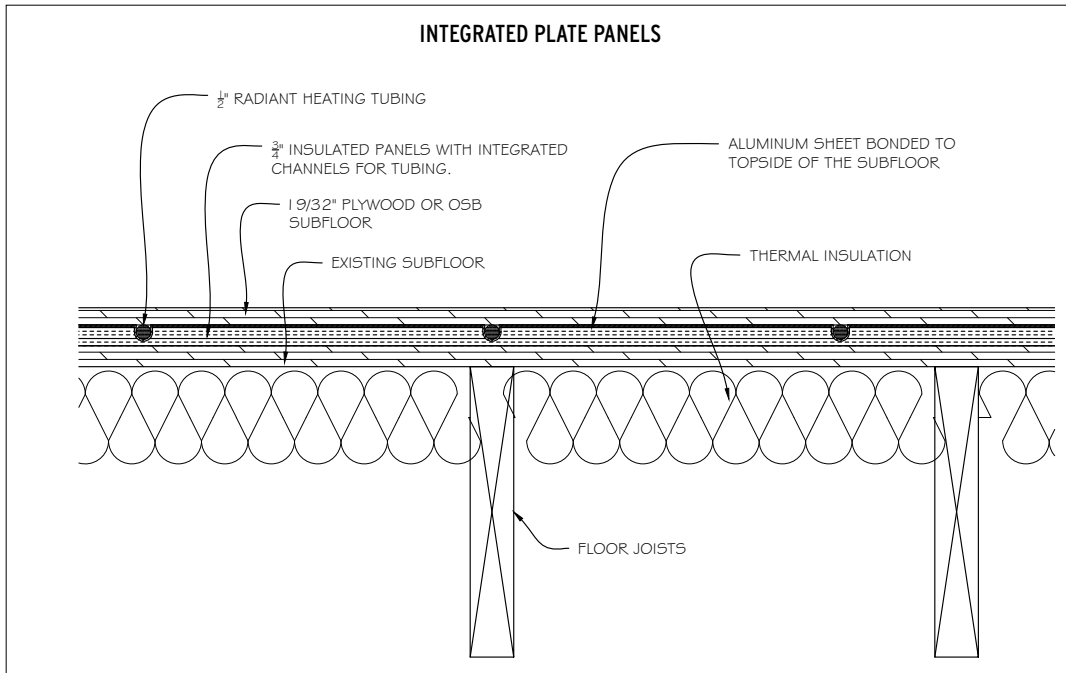

7. **Preformed Support Panels:** Molded panels designed to hold the radiant tubing cover the entire subfloor surface. This system may incorporate insulation molded as part of the panel. Some systems are designed to be embedded in cement, while others have dense, stone-like tiles that are supported by the molded pedestals. They may also include metal heat transfer plates to help disperse the heat evenly.

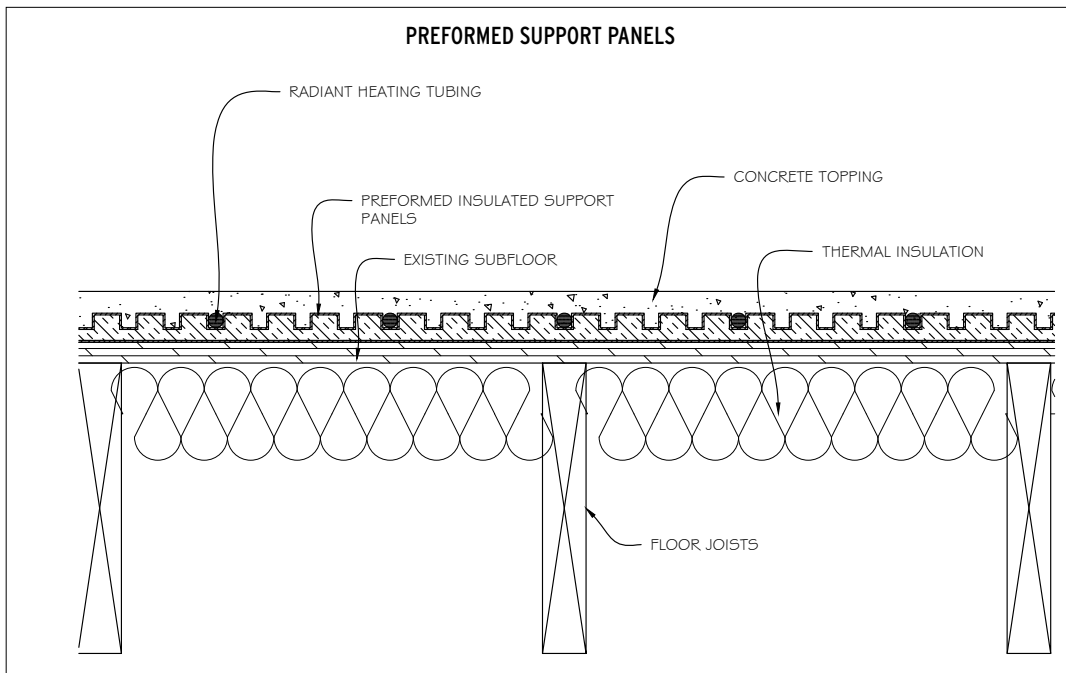

8. **Hanging/Attached Below Subfloor:** Radiant tubing is hung or attached to the underside of the subflooring in an airspace with insulation below. This requires higher water temperatures and has more-limited heat output than other systems. It is often used for retrofitting when access from below is possible. Suspended systems have more-even joist cavity temperatures than when the pipe is attached in direct contact with the subfloor joists.

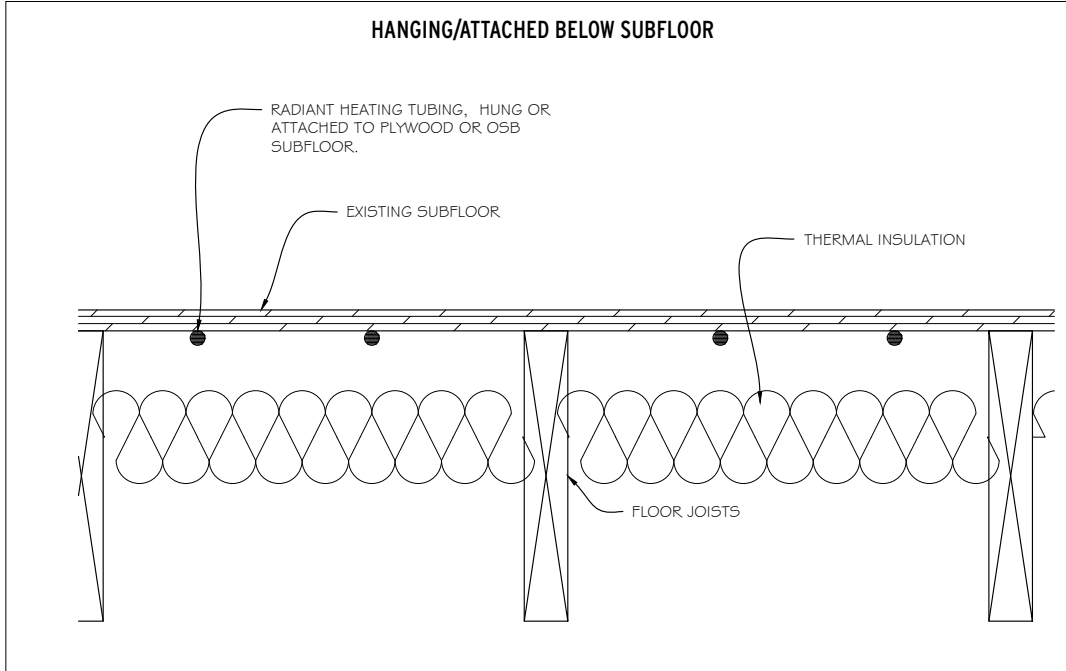

9. **Plates Below Subfloor:** Radiant tubing is attached to the underside of the subfloor with metal plates to diffuse the heat. This type of system has higher water temperatures and more limited heat output than above subfloor systems, but plates make it more effective than suspended pipes under the joists. It is often used for retrofitting when access to joist space is available.

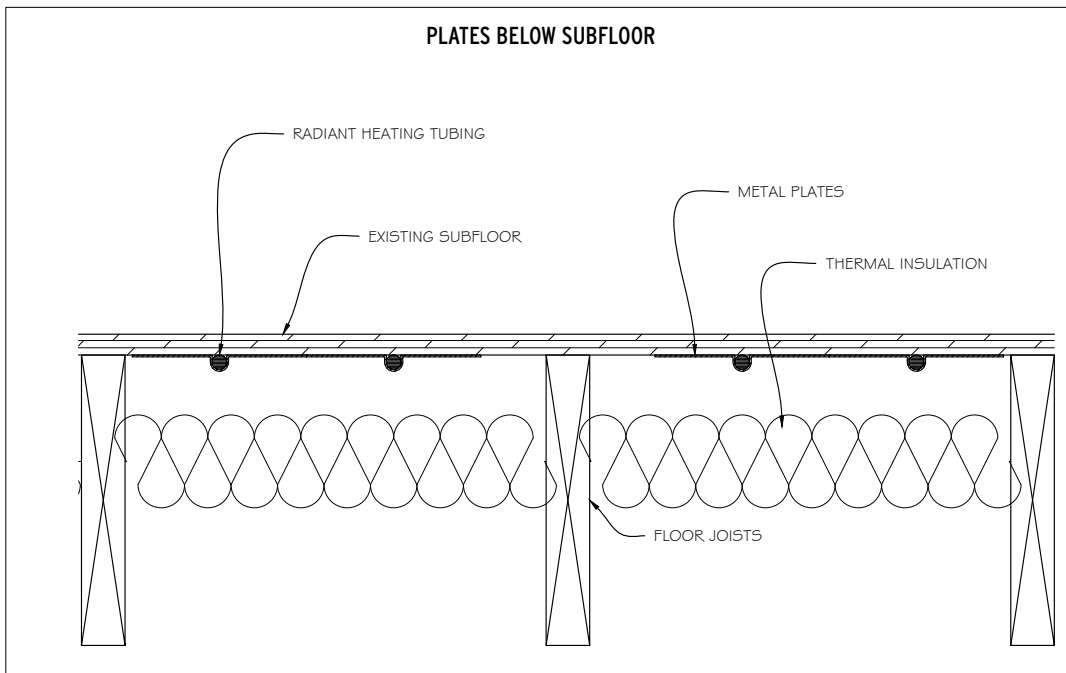

10. **Joist Bay Convection Plates:** The radiant tubing is suspended in a clear airspace beneath the subfloor and between the joists with metal plates or fins attached to the tubing. The tubing and metal fins heat the air within the joist space, which in turn, heats the subfloor. Higher water temperatures are also required than in systems with the plates in direct contact with the floor. Tubing is normally run parallel to the joists or perpendicular when holes are drilled to accommodate the tubing.

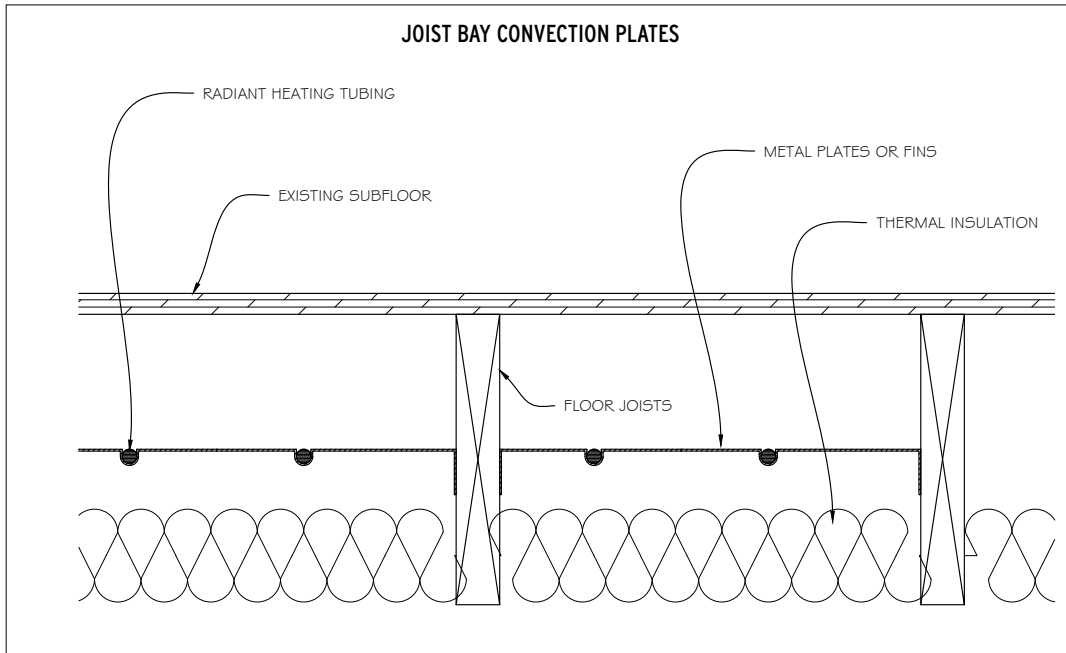

- B. **Electric Radiant Heating:** An underfloor heating or warming system that involves the conversion of electrical energy to heat. Types of electric radiant heating systems include:
1. **Self-Regulating Heating Cable:** This cable is made of a semi-conductive polymer and is self-regulating. It is to be embedded in a concrete slab. This product comes in a variety of voltages including low-voltage, 120V, 208V, and 240V versions.

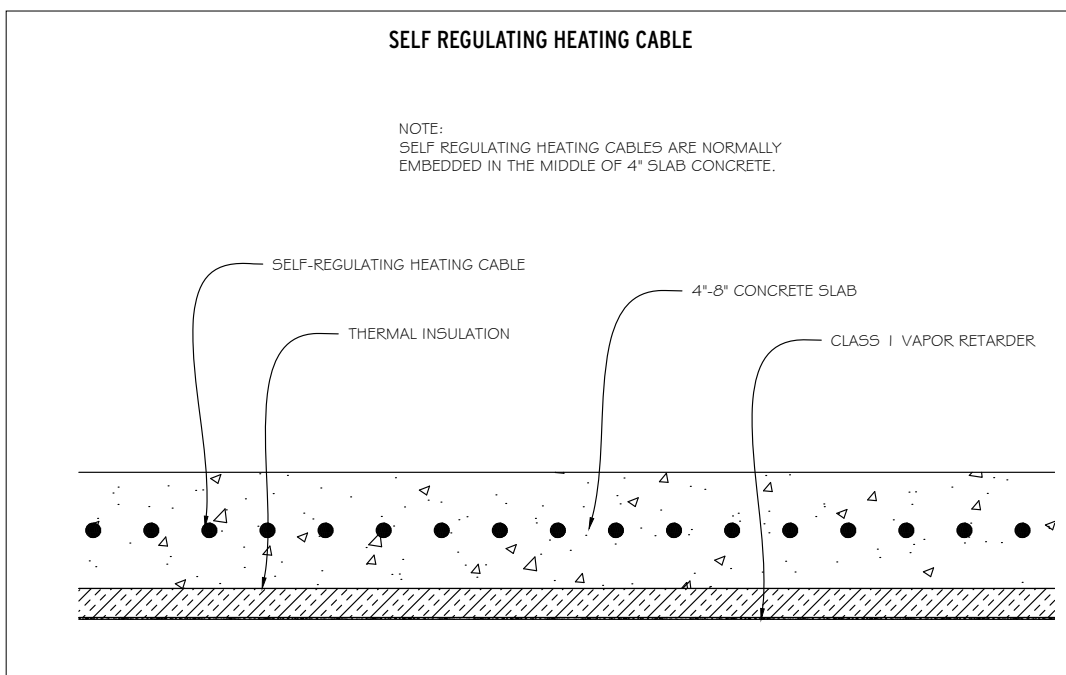

2. **Heating Cable on Holding Mesh:** The constant-wattage heating mat normally is embedded in the slab or in a thin topping of self-leveler underlayments, trowelable underlayments, floor fills, or lightweight concrete set above the subfloor or between screeds/sleepers. These heating mats are available in a variety of voltages including low voltage, 120V, 208V, and 240V versions.

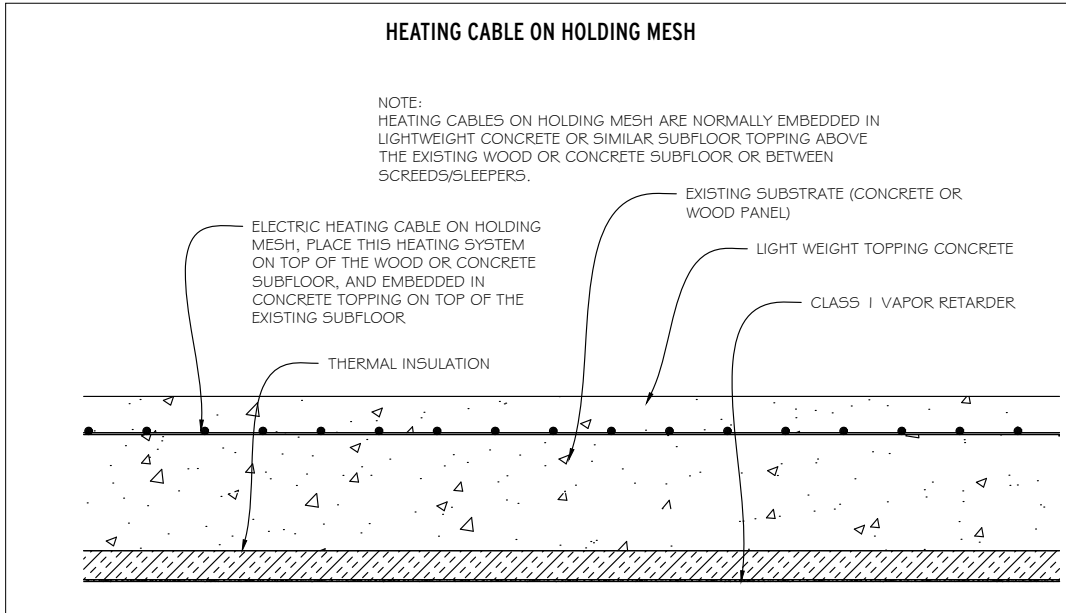

3. **Heating Cable Positioned by Straps or Ties:** The constant-wattage heating cable is held in place by straps, ties, or fixing strips, and embedded in the slab or in a thin topping of self-leveler underlayments, trowelable underlayments, floor fills, or lightweight concrete set above the subfloor or between screeds/sleepers. The heating cable is available in a variety of voltages including low-voltage, 120V, 208V, and 240V versions.

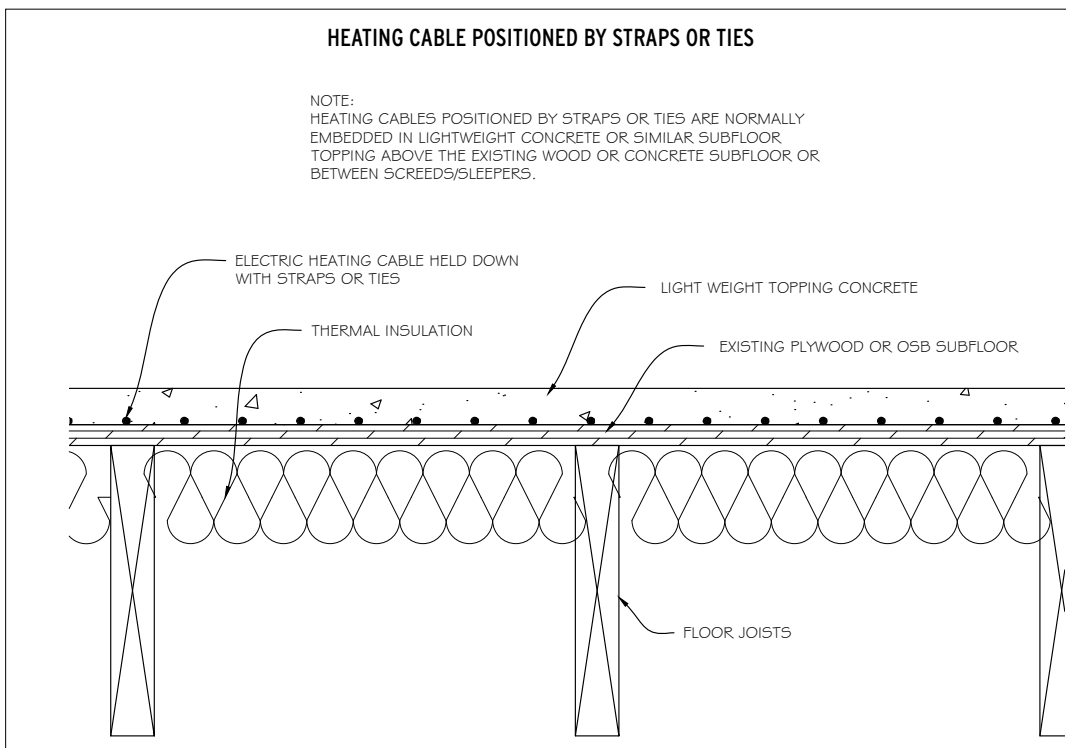

4. **Heating Cable Embedded in Fabric Mat:** Heating cables encased in a fabric carrier mat. The heating mat is embedded in a thin topping of self-leveler underlayments, trowelable underlayments, floor fills, or lightweight concrete set above the subfloor. This product comes in a variety of standard and custom sizes, as well as a variety of voltages including 120V, 208V, and 240V versions.

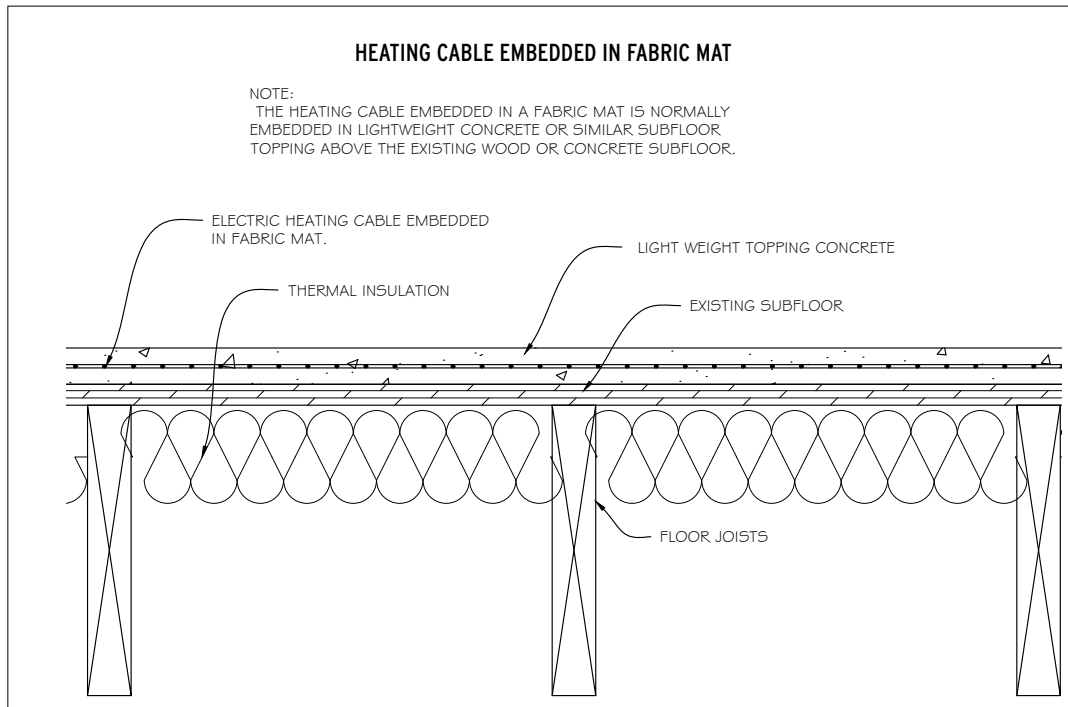

5. **Low-Voltage Heating Metal Screen:**

This mesh heating product is designed to be installed under the flooring, under the subfloor, embedded in a thin topping of self-leveler underlayments, trowelable underlayments, floor fills, or lightweight concrete, or between the joists. The heating mesh can be used in direct nail-down situations (when recommended by the flooring manufacturer). This product comes in low-voltage only.

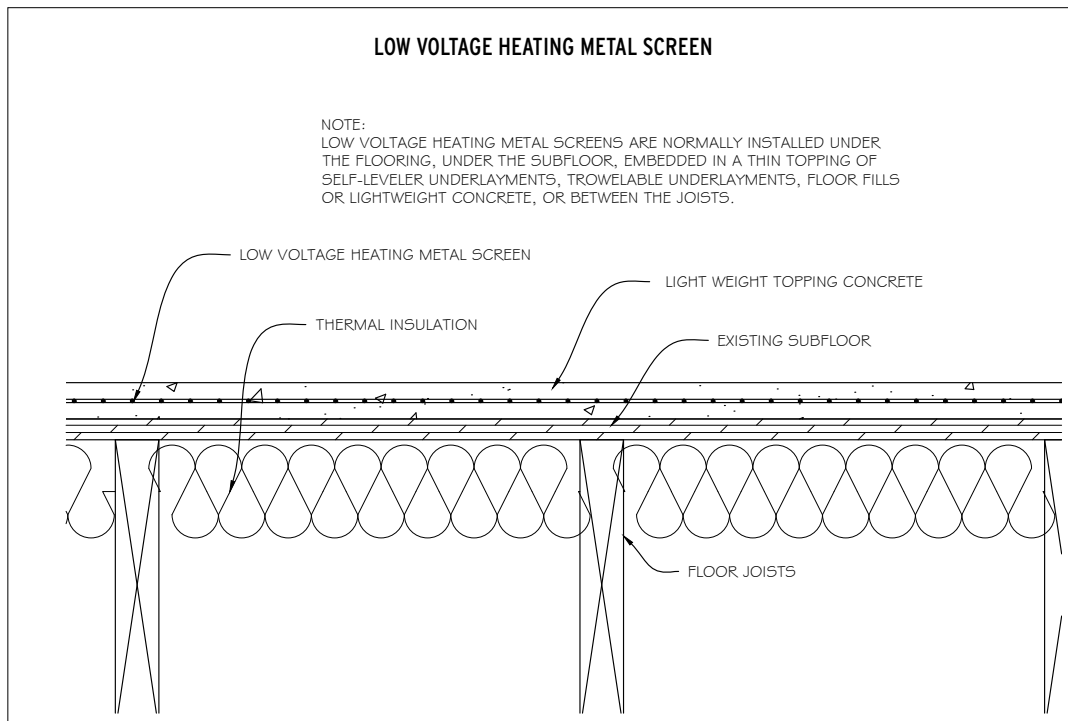

6. **Low-Voltage Polymer Heating Mat:** This mat is made of a semi-conductive polymer and is self-regulating. The heating mat can be embedded in a thin topping of self-leveler underlayments, trowelable underlayments, floor fills, or lightweight concrete, or directly under the floor covering. This product comes in low-voltage only.

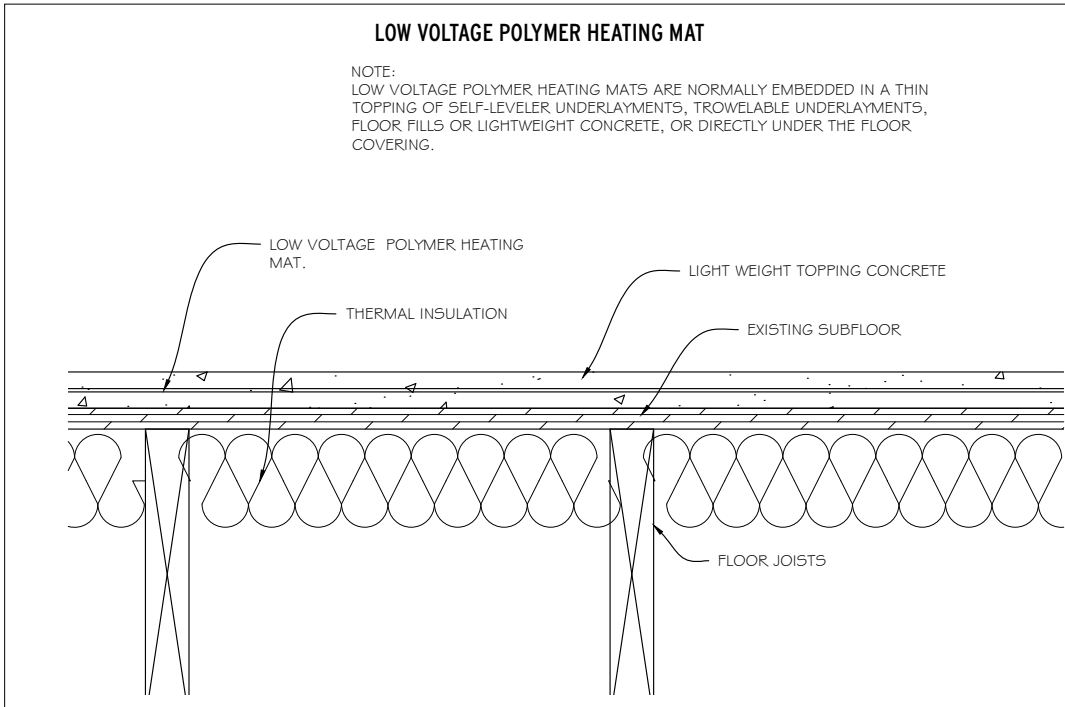

7. **Self-Regulating Nano Poly Carbon Heating Mat:** This mat is made of extruded homogeneous semi-conductive polymer and can be cut to size. Normally low-voltage or powered by solar panels. The heating mat can be embedded in a thin topping of self-leveler underlayments, trowelable underlayments, floor fills, or lightweight concrete, or stapled between joists, or directly under the floor covering.

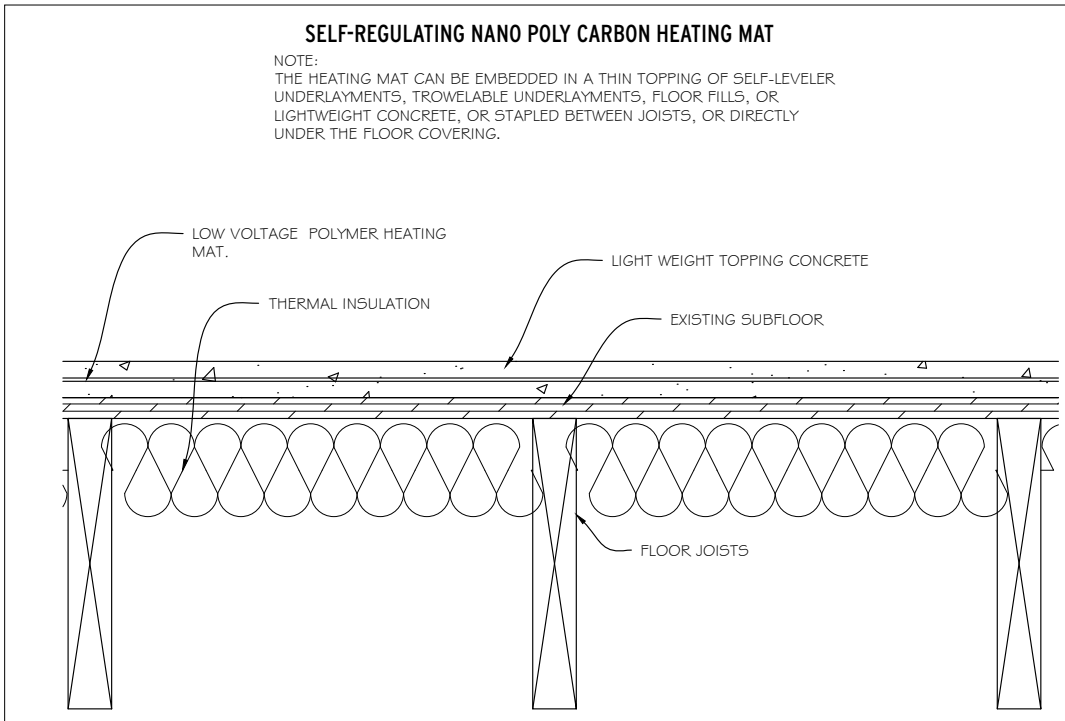

8. **Polymer Film Heating Mat:** These mats consist of a thin and flat printed heater encased between layers of polymer film. The mat is designed for installation directly under the flooring, under the subfloor, or between the joists. The polymer film heating mat comes in a variety of voltages including low-voltage, 120V, 208V, and 240V versions.

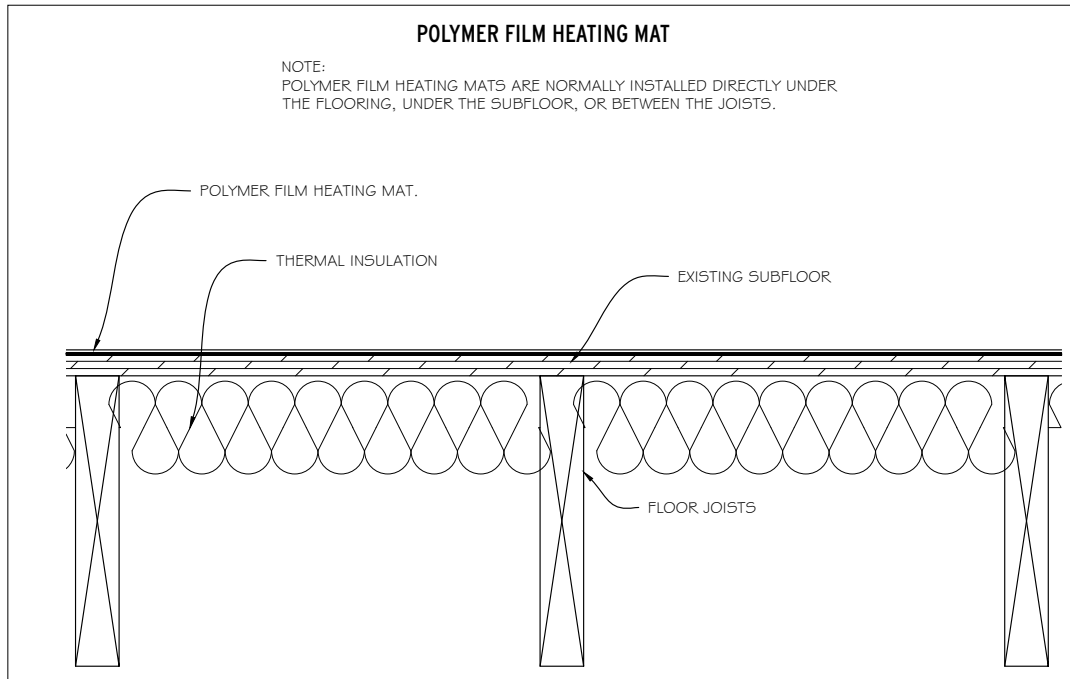

9. **Fabric-Heating Underlayment or Mat with Thermal Cut Off:** Thin constant wattage heating element, having thermal-cut-off (TCO) overheat protection is encased between two layers of fabric and/or a breathable underlayment. The fabric-heating underlayment is designed to be in direct contact with the wood floor covering. These systems provide heating, thermal insulation, and noise reduction. The fabric-heating underlayment may be embedded in a thin topping of self-leveler underlayments, trowelable underlayments, floor fills, or lightweight concrete set above the subfloor. This fabric-heating underlayment or mat is offered in a variety of voltages including 120V, 208V, and 240V versions.

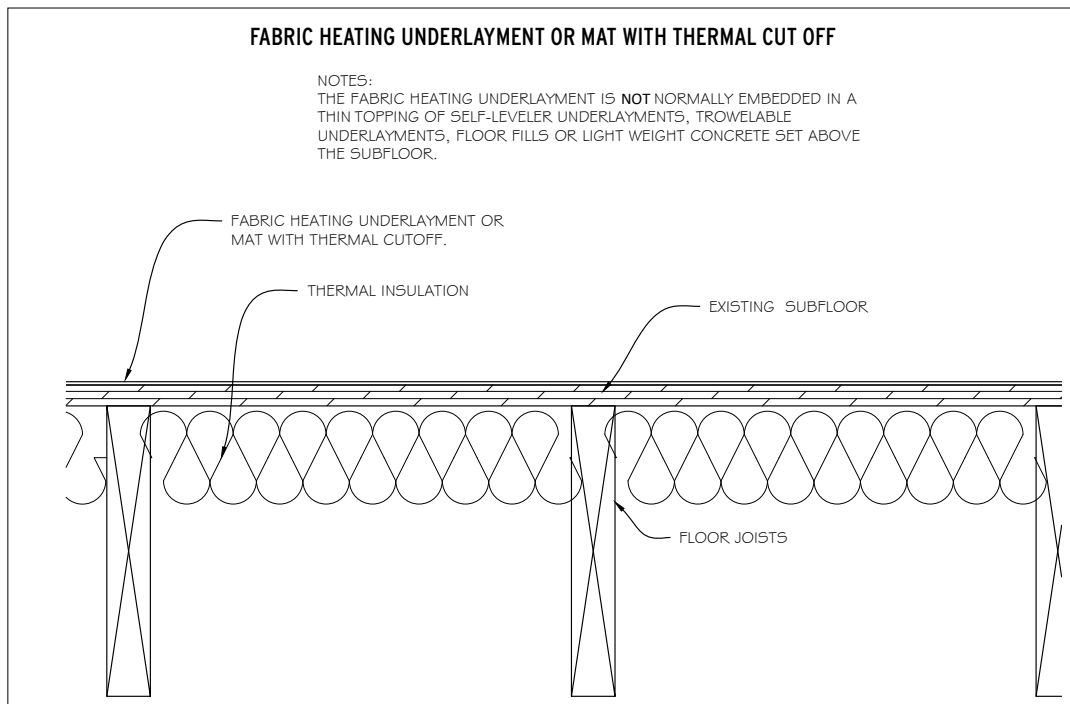

10. **Metal Foil Heating Mat:** These products are designed for floating floor installations only. These floor heating products are not embedded, glued down, or glued to. These products are designed to float below the flooring pad/underlayment, below the subfloor, or between joists. This product comes in a variety of voltages including 120V, 208V, and 240V versions.

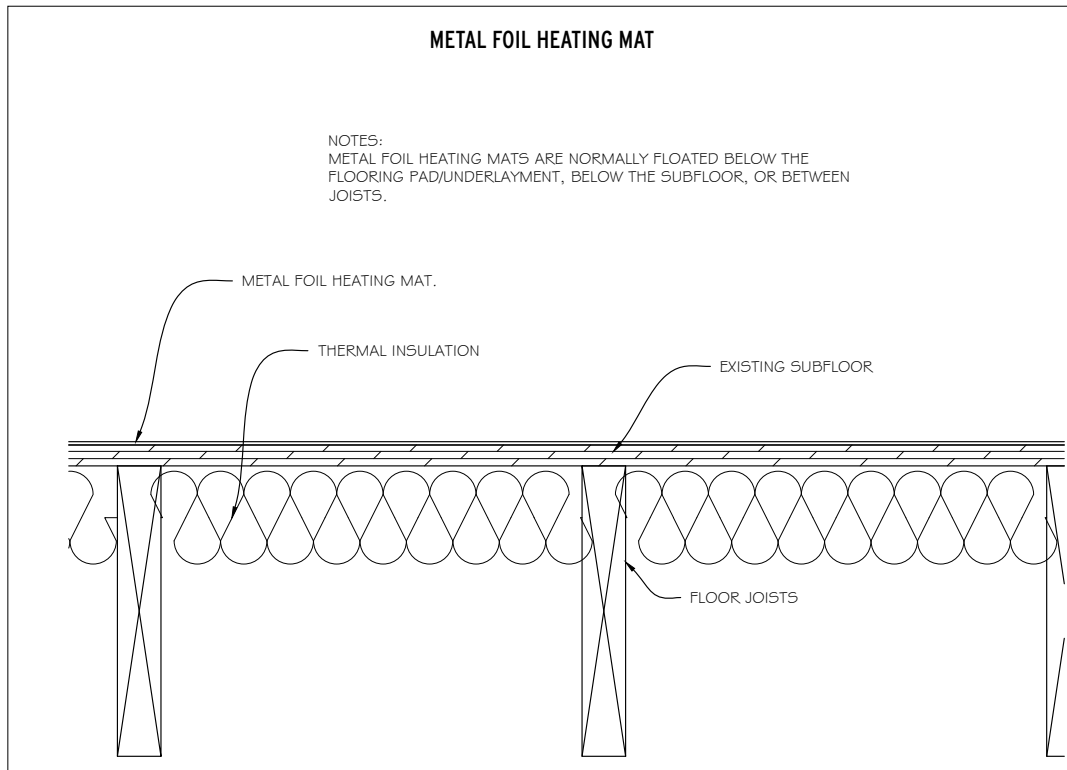

PART II Radiant Heating System Requirements

- A. Radiant heating systems are designed to either be the sole heating source (floor heating), or a part of a larger heating system (floor warming). Regardless of their intended use, when placed under a wood floor, they must do so without damaging the floor.
- B. To provide an adequate thermal environment for the end-user, many factors must be taken into account, including the size of the room, the construction of the home, R-value of the windows, HVAC systems, the number and age of the occupants, and the interior finishes that may be directly affected by these requirements.
- C. The builder, the radiant heating system design engineer, and the radiant heating system installer should be made aware of the type of floor covering being installed over the radiant heating system in order to adequately pair the

system with the flooring requirements, based on the facility in which they are being installed. This design coordination should consider whether the heating system is expected to be the sole heating source, or a part of a larger heating system.

- D. Radiant cooling systems are never recommended under wood flooring.
- E. The radiant heat system design engineer and radiant heating system installer should make available a room-by-room heat-loss calculation based on all of the factors that will affect the heat output of the radiant system. This analysis must establish a maximum operating temperature of the heating system dependent on the floor covering being installed over it.
- F. According to the American Society of Heating, Refrigerating and Air-Conditioning Engineers (ASHRAE), a floor surface temperature that creates optimal human comfort for most people lies somewhere between 70-80°F.

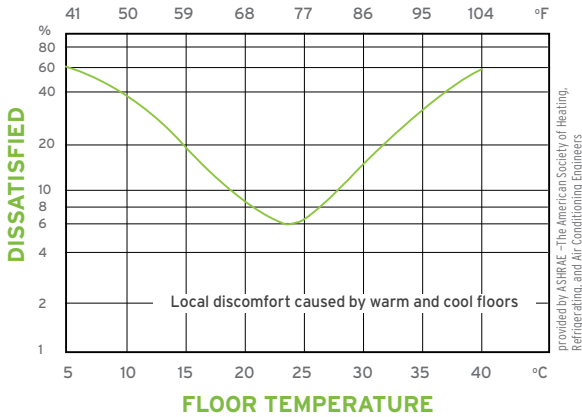

G. Unless otherwise specified by the wood flooring manufacturer, the heat-loss calculations designed for wood flooring installations should restrict the operating temperature of the radiant heat system to never allow the surface of the installed wood floor to exceed 80°F. The entire wood flooring system, including the wood product, the installation method, and the underlayment systems must be taken into account.

1. Where radiant hydronic heating systems are installed, this heat-loss calculation analysis should establish a maximum heat gain of 20 BTU/hr/sf from the floor heating system, for each room receiving wood flooring. If the ambient conditions of the airspace cannot sufficiently be maintained at 70°F with the radiant heating system operating at a maximum 20 BTU/hr/sf floor load, a supplemental heating system will be necessary.
2. Where electric radiant heat systems are installed as the sole heating source, the heat-loss calculation analysis should establish a maximum heat gain of 20 BTU/hr/sf from the floor heating system using a maximum 6 watts per sf/hr for each room receiving wood flooring. If the ambient conditions of the airspace cannot sufficiently be maintained at 70°F with the radiant heating system operating at a maximum 20 BTU/hr/sf floor load, a supplemental heating system will be necessary.

H. Separation of heating zones and thermostats, based on flooring type and temperature limitations, is required when multiple floor coverings are being installed over any radiant heating system.

I. The radiant heating system should provide an even distribution of heat to the wood flooring surface. The wood floor surface temperature should vary no more than 3°F at any point within the installed wood floor.

J. In locations where the radiant heating tubing layout becomes bunched together (through hallways or where it emanates to or from the manifold), it will be necessary for the heating

system installer to insulate the tubes in these areas of high-density to avoid creating high-density heat situations, which can impact the wood flooring performance.

K. Wood flooring performs best with subtle changes in temperature. The floor should not fluctuate by more than 5°F per day.

1. For hydronic radiant heating systems, an outdoor reset control (zone reset controls) with high/low temperature settings (to minimize the boiler temperature), along with an in-floor sensor, should be installed with the system to minimize the effects of rapid changes in temperature. These sensors and thermostats allow the heating process to be gradual and based on small incremental increases in relation to the exterior temperature. "Set back" or programmable thermostats could vary room temperature greater than 5°F per day, and should not be used.
2. For electric radiant heating systems, a thermostat along with an in-floor sensor must be installed with the electric floor heating system to minimize the effects of rapid changes in temperature. It is also recommended to use a thermostat that would limit floor temperature changes to 5°F per day.

L. Items such as area rugs, mattresses, exercise mats, pet beds, bean bags, or other highly insulating products that cover the floor will trap heat and increase the temperature of the floor it is covering, which can result in irreversible damage to any type of floor. When the floor is expected to be covered, the radiant heating design engineer, and the radiant heating installer should calculate and factor-in the R-value of the specific insulating item that will be covering the floor, and make adjustments to the heating output as necessary. The end-user should consider the effects of heat build-up and subsequent flooring damage.

M. All radiant heating systems should be fully operational, regardless of season, for a minimum of 5 days prior to delivery of wood flooring. Keeping the system on helps force out moisture and ensures the system is operational prior to flooring install.

1. Water-heated (hydronic) radiant-heat systems should be pressure tested, all system controls should be fully operational, and functional operating results should be made available by the system installer.
2. Electric underfloor systems should be tested for proper operation, and functional operating results documented and made available to the wood flooring installer by the heating system installer.

N. The end-user should be made aware of the importance of proper usage of the entire radiant heating system by the radiant heating system design engineer and the radiant heating

system installer as it directly relates to the floor covering installed over it. The wood floor installer should provide maintenance instructions related to the heating and relative humidity requirements of the wood floor to the end-user.

PART III

Wood Flooring Selection over Radiant Heat

- A. Most wood flooring can be installed over radiant heat, providing all of the necessary conditions are met.
 - 1. Successful wood floor installations occur when the radiant heat system design engineer, the radiant heating system installer, the wood flooring installer, and the end-user all communicate and fully understand what is required for the entire flooring system being installed.
 - 2. This communication should include which type of wood flooring to use, what installation method to use, understanding how this heat source may impact the wood flooring, what precautions to take before-, during- and after-installation, and consistent communication between all parties when any changes take place to any part of the system.
- B. The types of wood flooring best suited for under-floor radiant heat systems should be accounted for to ensure long-term performance. The flooring categories directly affecting the dimensional stability of the wood flooring often include:
 - 1. **Flooring cut:** Wood is a hygroscopic and an anisotropic material, meaning it takes-on and throws-off moisture, and it shrinks and swells differently in each direction, dependent on changes in moisture. How the wood changes dimension is largely influenced by the species characteristics and the way in which the wood is cut from the tree. The way in which it is cut from the tree for solid or sawn flooring is classified as plainsawn, quartersawn, riftsawn, livesawn, or end-grain. Quartersawn and riftsawn wood flooring is more dimensionally stable in width than plainsawn or end-grain wood flooring.
 - 2. **Flooring width:** Wood changes dimension proportional to the width of the plank. Narrow boards expand and contract less than wider width boards of the same species and cut.
 - 3. **Flooring type:** Engineered wood flooring is, in general, more dimensionally stable than solid wood flooring. However, not all engineered wood flooring is recommended or appropriate for use over radiant heating systems. Engineered flooring with less-stable wear layer species such as hickory, beech, and maple are not normally best-suited over radiant heat, unless otherwise suggested by the flooring

manufacturer. The cut of the wear layer lamina (peeled, sliced, or sawn) can also affect how the floor performs over radiant heat. Follow the flooring manufacturer recommendations as to whether or not each specific product is intended to be used over radiant heat.

- 4. Wood flooring manufactured and expected to perform at MC levels higher than 9% or in conditions above 50% RH, should not be used with radiant heating systems unless otherwise recommended by the flooring manufacturer.
- 5. **Species:** Both in solid and engineered flooring options, certain species are known for their inherent dimensional stability such as American chestnut, black cherry, black walnut, and others. Less-stable species such as hickory, beech, and maple are less-suitable for use over radiant heat.

Solid Tangential Shrinkage (Green to Oven-dry)

Less Stable	Species	Shrinkage (%)
	Hickory, True	12.6
	Beech	11.9
	Oak, White	10.5
	Maple, Hard	9.9
	Birch, Yellow	9.5
	Elm	9.5
	Jarrah	9.4
	Birch, Red	9.0
	Hickory / Pecan	8.9
	Birch, Silver	8.6
	Oak, Northern Red	8.6
	Jatoba, (Brazilian Cherry)	8.5
	Wenge	8.1
	Ipe/Lapacho, (Brazilian Walnut)	8.0
	Ash, Black/White	7.8
	Golcalo Alves, (African Walnut/Tigerwood)	7.8
	Walnut, American Black	7.8
	Cumaru, (Brazilian Teak)	7.7
	Pine, Southern Yellow	7.5
	Alder, Red	7.3
	Douglas Fir	7.3
	Sapele	7.2
	Maple, Soft	7.2
	Cherry, Black	7.1
	Chestnut	6.7
	Pine, Lodgepole	6.7
	Mahogany, Santos	6.2
	Koa, (Acacia)	6.2
	Pine, Ponderosa	6.2
	Purpleheart	6.1
	Pine, Eastern White	6.1
	Teak, Thai / Burmese	5.3
	Padauk	5.2
	Merbau	4.8
	Teak, Rhodesian	4.5
	Iroko	3.8
	Mesquite	3.2
More Stable	Cypress, Australian	2.8

- C. A supplemental humidity control system is often necessary, and should be specified into any radiant heat wood flooring project, in order to properly support ambient airspace conditions between 30% - 50% RH, or as otherwise required by the wood flooring manufacturer. Supplemental humidification should be present and operational prior to delivery, during and post-installation of the wood flooring.
- D. Wood flooring selection should be aligned with the conditions in which it is expected to perform. With the heating source placed directly below the installed wood flooring, the moisture content will forcibly be reduced during the heating season if supplemental humidification is not added.
- E. In-floor, or under-floor temperature and humidity data-logging devices are recommended to be installed by the radiant system installer or the flooring contractor, to monitor the conditions in the space after the floor has been placed into service. Placement of these sensors should be determined with the assistance of the radiant heating system installer in order to gain the most-accurate floor temperature readings.
- F. The end-user should have a clear understanding of the flooring product, maintenance requirements, humidification systems, data loggers, and the radiant heating system features, limitations, and abilities, to ensure adequate conditions are maintained year-round.

PART IV Installation Methods over Radiant Heat

Radiant heating systems may be installed within, above, or below any substrate. Substrates may include concrete, wood, screeds/sleepers or a combination of any of these. The type of flooring specified, the flooring manufacturer requirements, and the subflooring system will dictate the flooring installation method.

- A. Nail-Down over Wood Panel Subfloor
 - 1. Refer to the Nail-Down Installation chapter for details on proper installation methods, unless otherwise directed by the flooring manufacturer.
 - 2. Subfloor surface temperature should not exceed 80°F at the time of installation.

- 3. A class II vapor retarder should be placed over a wood subfloor and below the wood flooring when being installed over an unconditioned space (refer to the Underlayments: Moisture Control chapter). Do not use asphalt- or bitumen-type vapor retarders over radiant heat systems.
- 4. Where a wood panel subfloor has been installed over a concrete slab, install a Class 1 impermeable vapor retarder over the slab, and under the wood panel subfloor in all on- and below-grade applications, and when calcium chloride readings are greater than 3 pounds, relative humidity readings are greater than 80%, or calcium carbide readings are greater than 2.5%.
- 5. Fastener length should be taken into account to avoid penetration of the vapor retarder.
- 6. Avoid penetration of the heating tubes/elements with wood flooring fasteners. Length and placement of fasteners must be assessed and addressed prior to and during the install.
- 7. When the required fastener schedule cannot be followed due to the type of radiant heating system being used, an alternative installation method may be necessary. This may include any of the following:
 - a. Nail-assisted glue-down (the use of an elastomeric adhesive in conjunction with the mechanical fasteners is recommended any time fastener length, fastener schedule, or any portion of the installation would benefit from additional hold-power).
 - b. Full spread glue-down.
 - c. Floating installation methods.
- B. Direct Nail to Screeds/Sleepers
 - 1. Refer to the Screeds/Sleepers chapter for proper nail-down installation methods over screeds/sleepers, unless otherwise directed by the flooring manufacturer.
 - 2. The subfloor surface temperature should never exceed 80°F at the time of installation.
 - 3. A vapor retarder should be installed below the screeds/sleepers. Do not use asphalt- or bitumen-type vapor retarders over radiant heat systems.

4. Hydronic tubing and electric elements typically are installed into the channels between the screeds/sleepers, and then embedded in a gypsum or lightweight concrete mix, which is poured even with the top of the screed/sleeper. This should present a flat surface that minimizes any air space between the subfloor and the flooring. The heating tubes/elements should be submerged enough below the surface of the screeds/sleepers that the wood flooring does not come into direct contact with the heating tubes/elements.
5. When nailing down a wood floor, consider the screed/sleeper placement in comparison to the angle of the fastener to avoid penetrating into any radiant heating tubes or elements.
6. When the required fastener schedule cannot be followed due to the placement of the screeds/sleepers, an alternative installation method may be necessary. This may include any of the following:
 - a. Nail-assisted glue-down (the use of an elastomeric adhesive in conjunction with the mechanical fasteners is recommended any time fastener length, fastener schedule, or any portion of the installation would benefit from additional hold-power).
 - b. Full spread glue-down.
 - c. Floating installation methods.

C. Glue-Down

1. Refer to the Glue-Down Installation chapter for details on proper installation methods, unless otherwise directed by the flooring manufacturer.
2. The heat will need to be reduced or even turned off during installation of the flooring to avoid premature drying and skinning-over of the adhesive. Check with the adhesive manufacturer for minimum/maximum subfloor temperature limitations during the installation.
3. The subfloor surface temperature should never exceed 80°F at the time of installation.
4. Do not fill the channels containing radiant tubing with adhesive.

5. Install a Class 1 impermeable vapor retarder over the slab in all on- and below-grade applications, and when calcium chloride readings are greater than 3 pounds, relative humidity readings are greater than 80%, or calcium carbide readings are greater than 2.5%. Use an adhesive and moisture control system suitable for the flooring being installed and for the radiant heating system it is being installed over. Do not use asphalt- or bitumen-type vapor retarders over radiant heat systems.
6. Note: When using the in-situ relative humidity tests (ASTM F2170), be extremely cautious when drilling into the slab where hydronic tubing or electric heating elements have been embedded, so as to not damage or puncture the heating system. Use of infrared cameras or heat-detecting devices may assist in identifying a safe location for testing.

D. Floating Engineered

1. Refer to the Floating Installation chapter for details on proper installation methods, unless otherwise directed by the flooring manufacturer.
2. Subfloor surface temperature should never exceed 80°F at the time of installation.
3. The insulating properties (R-values) of flooring underlayment pads vary, and may compromise the radiant heat efficiency. The pad R-value should be taken into account during the design and specification of the heating system. Do not use asphalt- or bitumen-type vapor retarders over radiant heat systems.
4. For edge-glued floors, ensure the glue recommended by the flooring manufacturer is approved for use with radiant heat.

E. Direct-Nail through Low-Voltage Radiant Systems

1. Refer to the radiant heating manufacturer installation instructions prior to nailing through any electric radiant heating system.
2. Refer to the flooring manufacturer for proper installation methods over these types of heating systems.

SUBSTRATES: Existing Flooring

Installation over existing floorcoverings is not uncommon, and is often necessary. In situations where asbestos or lead are present in the home, disturbing the existing floorcovering may not always be the best option. Wood subflooring may be installed over an existing floor covering as an alternative (refer to the Wood Subfloors over Concrete chapter for direction).

PART I

Existing Wood Floors

- For glue-down, nail-down, or floating installation methods, follow the installation method as detailed in the applicable chapter.
- Follow all involved manufacturer's instructions for proper installation methods over existing flooring.
- Installing new wood flooring parallel to an existing solid nail-down wood floor will require an overlay of minimum $\frac{11}{32}$ " (9.5mm) subfloor panels installed over the existing floor. Refer to the Double-Layer Subfloor Systems section in the Wood Subfloors chapter for installation processes.

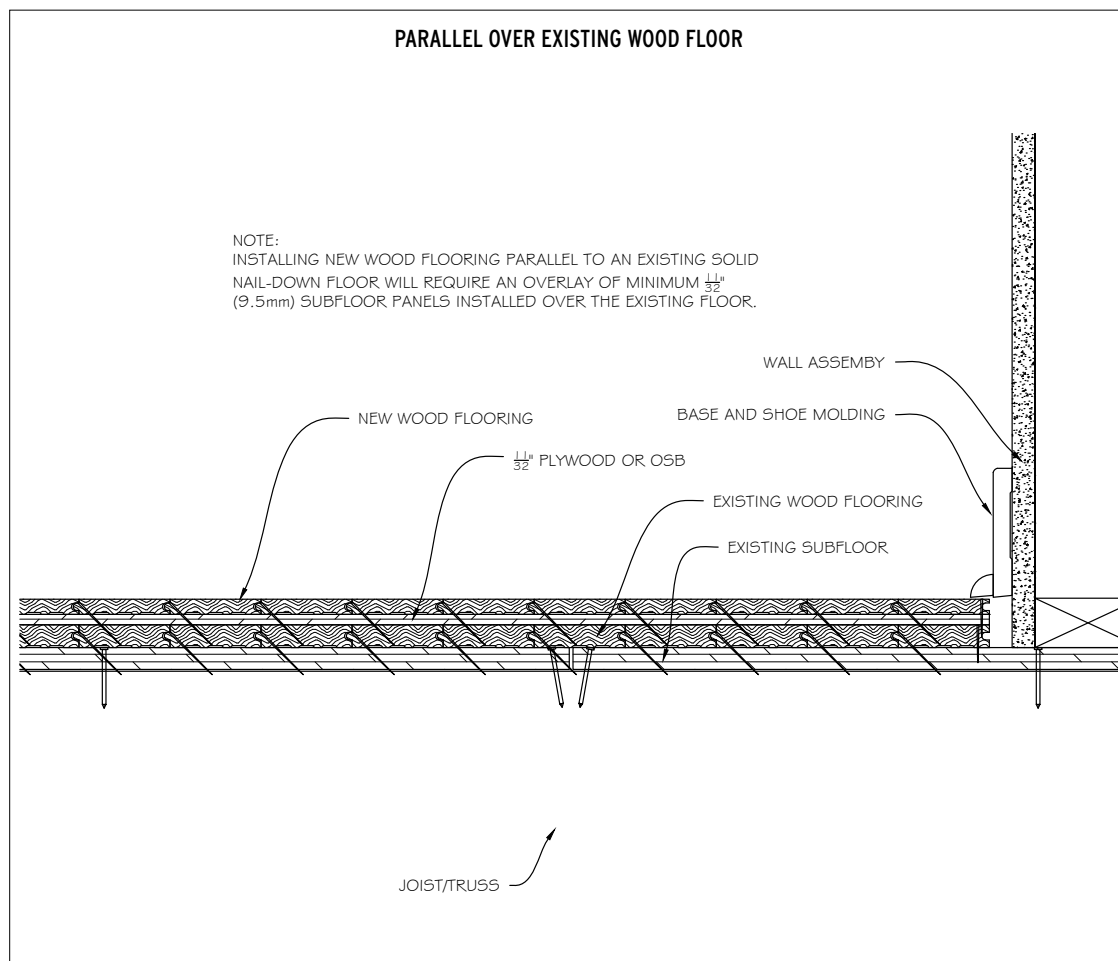

- D. The existing floor should be flat to within 1/4" in 10' or 3/16" in 6'.
 - 1. Sand off old finish and high spots in the existing floor. Repair, replace, or refasten loose flooring as necessary. Caution: Do not sand any surfaces containing lead finishes or paints, or containing asbestos. Check applicable local and federal EPA and OSHA regulations. (Refer to the Safety chapter for more information.)
- E. The existing wood floor and the new wood floor should be within 2% MC for plank (≥ 3 " width) flooring, and within 4% MC for strip (< 3 " width) flooring, of each other.
- F. Always install a new nail-down or glue-down wood floor perpendicular to or on diagonal to the existing floor.

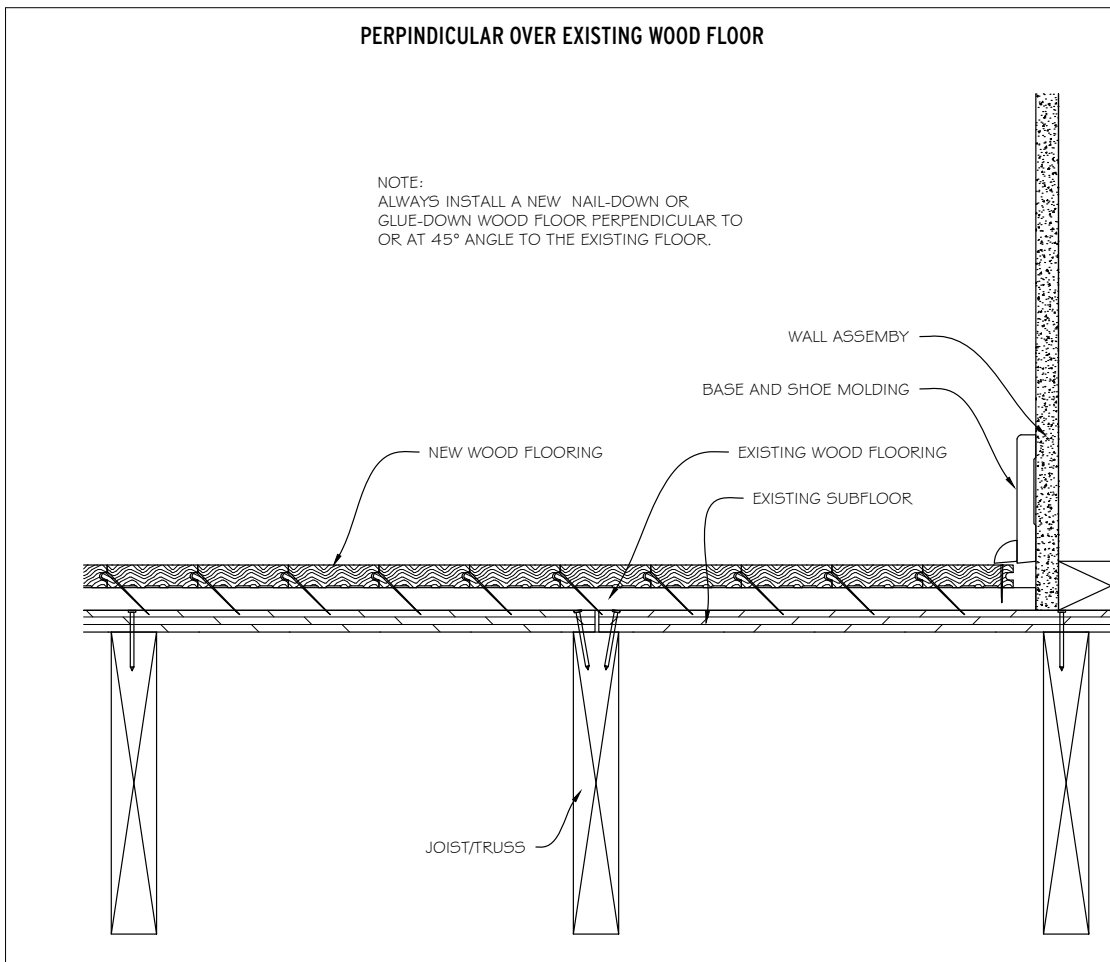

- G. When floating a new wood floor over an existing wood floor, the direction of the new floor does not matter.
- H. Where the existing 3/4" wood flooring is installed directly to the joists/trusses, install new flooring perpendicular or on diagonal to the direction of the existing flooring; otherwise, overlay the existing floor with minimum 11/32" (9.5mm) subfloor panels.

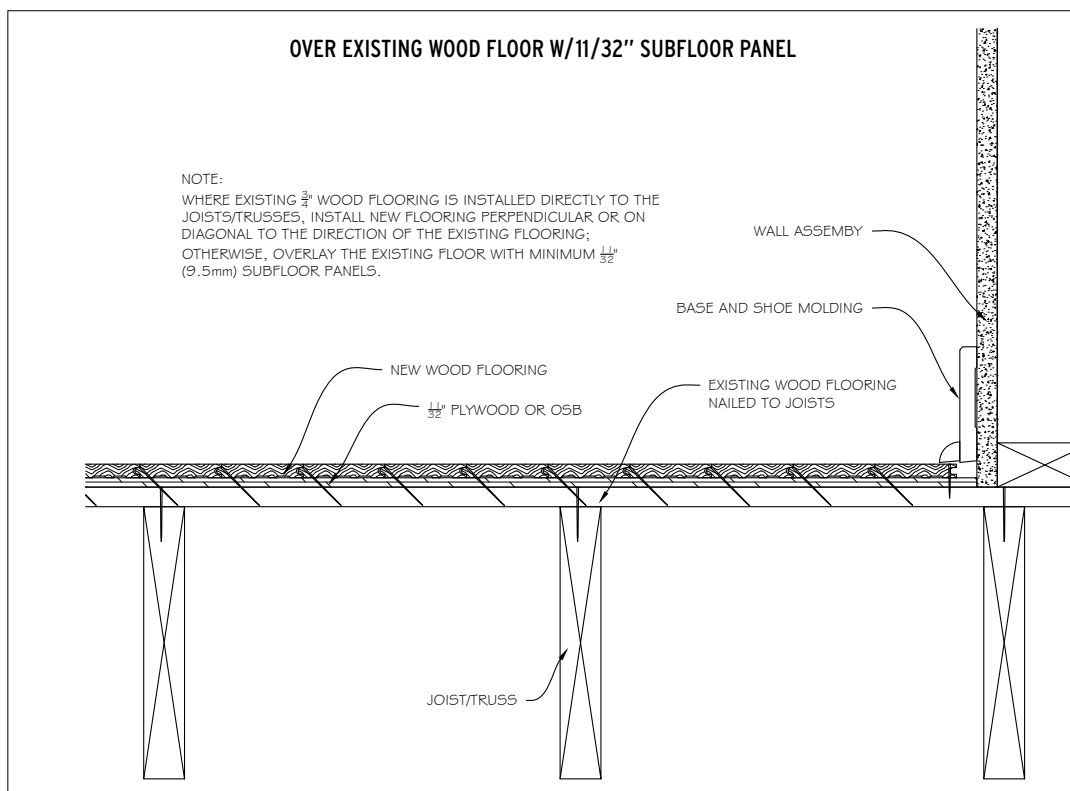
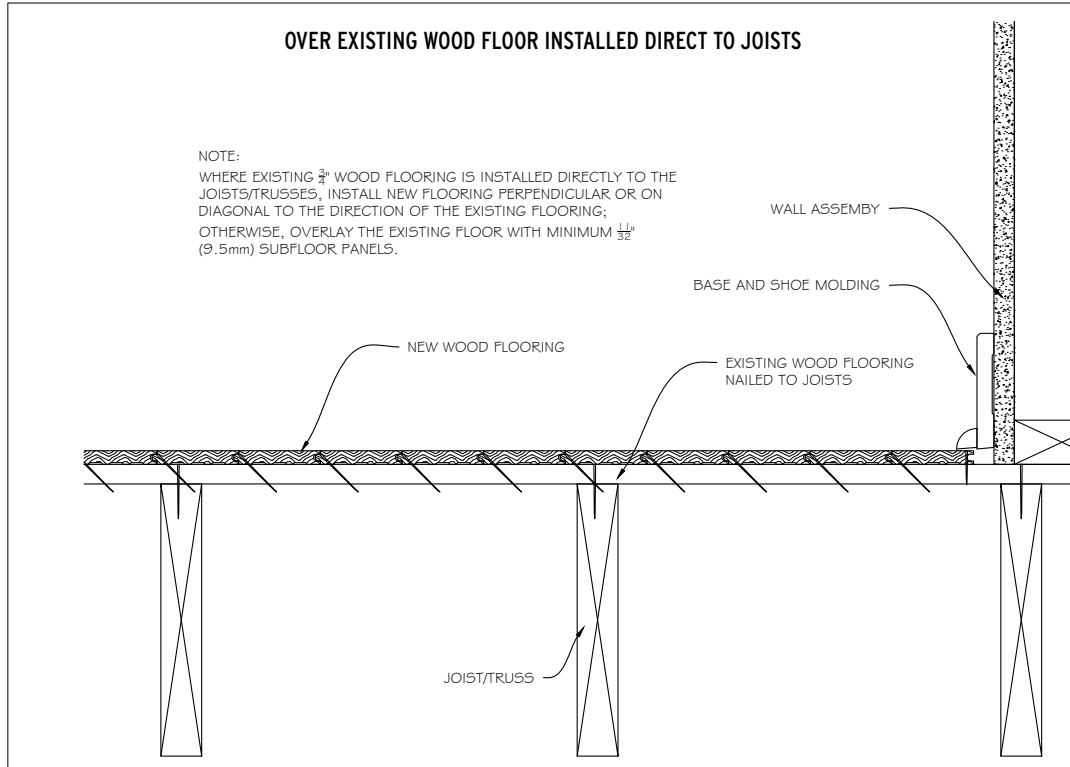

- I. When installing a new floor over an existing glue-down floor, glue the new wood floor directly to the existing wood floor. If the thickness of the floor will allow, you can nail the new floor to the existing floor.
- J. Never install a new wood floor over an existing floating wood floor.

PART II Existing Vinyl, Resilient Tile, Cork Flooring and Linoleum

- A. For glue-down, nail-down, or floating installations, follow the installation method as detailed in the applicable chapter.
- B. Follow all involved manufacturer's instructions for proper installation methods over existing flooring.
- C. The existing floor should be flat to within 3/16" in 10' or 1/8" in 6'.
- D. Make sure the floor covering materials are well-bonded to the subfloor/underlayment with full-spread adhesive and are no more than two layers thick, not to exceed 3/16 (5 mm). Remove any loose areas.
- E. The flooring fastener must penetrate the underlying wood subfloor by a minimum of 5/8".
- F. With approved wood/wood composite subfloors, if vinyl or tiles are loose, broken, or in poor condition, overlay the floor with a minimum 11/32" (9.5 mm) underlayment directly over the flooring materials.
- G. For glue-down installations, clean the flooring materials as necessary to create a good adhesive bond. Test for adequate adhesive bond and compatibility prior to installation.
- H. PVA adhesives are not recommended over vinyl, resilient tile, cork, or linoleum flooring.
- I. Other types of adhesives may require the use of a primer or vinyl blocker when installing over sheet vinyl, or vinyl and cork flooring. Follow the adhesive manufacturer's instructions.
- J. Test for adequate adhesive bond prior to the installation.
- K. If a maintenance material is present on the floor covering or a gloss is present, follow the adhesive manufacturer's instructions on compatibility and removal of the maintenance product. (NOTE: Do not sand any resilient products. They may contain asbestos fibers, which may be harmful.)
- L. Cork floors must be well-bonded to the substrate and have all sealers and surface treatments removed before installation begins. Always check for adequate adhesive bond.
- M. Never install a new wood floor over an existing floating floor.

PART III Existing Ceramic, Terrazzo, Slate and Marble

- A. Use only glue-down or floating installations methods over these types of substrates.
- B. Follow the instructions in the Concrete Subfloors chapter for more-detail on subfloor requirements.
- C. Follow the adhesive manufacturer's instructions for proper installation methods over existing ceramic, terrazzo, slate, or marble.
- D. The existing floor should be flat to within 3/16" in 10' or 1/8" in 6'.
- E. Remove any loose grout or tile.
- F. All grout joints and broken corners that exceed 3/16 (5 mm) must be filled with a cementitious leveling compound in conjunction with an appropriate primer for adhesion.
- G. All compounds used must have adequate dry time prior to new floor installation.
- H. The surface should be thoroughly cleaned, and all exiting sealers and surface treatments removed.
- I. Follow the Glue-Down Installation Methods chapter for installation instructions.
- J. The surface will likely require abrasion or scarification to create a good bonding surface for the wood flooring adhesive. Caution: Do not sand any surfaces containing lead finishes or paints, or containing asbestos. Check applicable local and federal EPA and OSHA regulations. (Refer to the Safety chapter for more information.)
- K. Test for adequate adhesive bond and compatibility prior to the installation.
- L. Wood subflooring may be installed over an existing floor covering as an alternative (refer to the Wood Subfloors over Concrete chapter for more information).

PART IV Existing Carpet

- A. Never install a wood floor over any type of carpet or carpet pad.

UNDERLAYMENTS: Moisture Control

Moisture vapor moves through materials naturally. The more porous a material is, the easier it is for moisture vapor to diffuse through it. The function of a vapor retarder is to control the entry of moisture vapor in and out of building assemblies. Protection against moisture involves utilizing moisture control systems through the entire building construction design, from the exterior of the building to the interior building envelope, including the wood floor system.

A properly designed building, and quality construction practices, protect the interior living space against the infiltration of moisture, and the effects of seasonal humidity and temperature fluctuations between the inside and outside of the structure.

Vapor Permeance: A property that describes the ease with which vapor molecules diffuse through a material. More specifically, vapor permeance is defined as the quantity of vapor flow across a unit area that will flow through a unit thickness under a unit vapor pressure difference.

Perm Rating: The standard measure of the water vapor permeability of a material. The higher the number, the more readily water vapor can diffuse through the material.

Vapor Retarder (also known as a vapor diffusion retarder): A layer of material that is used to control the rate at which moisture can move through a material.

PART I Vapor Retarder Classifications

The International Residential Code describes three classes of Vapor Diffusion Retarders (Class I, Class II, and Class III when tested in accordance with ASTM E-96 Test Procedure A – the desiccant or dry cup method):

- A. **Class I** vapor retarder ≤ 0.1 perm. Class I vapor retarders are also considered Vapor Impermeable Membranes or Vapor Barriers.
- B. **Class II** vapor retarder > 0.1 perm and ≤ 1.0 perm. Class II vapor retarders are also considered Vapor Semi-Impermeable Membranes.
- C. **Class III** vapor retarder > 1.0 perm. Class III vapor retarders are also considered Vapor Semi-Permeable Membranes.

PART II Vapor Retarders over Wood Subfloors

When installing wood flooring over a wood subfloor, identify if the space directly below the flooring is a conditioned space or an unconditioned space:

- A. **Conditioned space** is an area or room within the building that is intentionally heated or cooled, and humidified or dehumidified, to be maintained at the same conditions as the living/interior space either for the comfort of occupants, or for preserving temperature and humidity-sensitive goods.
 1. No vapor retarder is necessary over the wood subfloor and under the wood floor when the flooring is being installed over a conditioned space that is maintained at the same temperature and humidity as the living space directly above, unless otherwise directed by the flooring manufacturer.
 2. No vapor retarder should be installed over the wood subfloor and under the wood floor, where a Class I or Class II vapor retarder has been installed on the underside of the joists.
- B. **Unconditioned space** refers to exterior space or spaces within the shell of a building that is neither directly nor indirectly heated, cooled, humidified, nor dehumidified.
 1. A Class II vapor retarder (sheet-good or liquid-applied) may be used on wood subfloors over unconditioned spaces to slow the rate at which potential moisture-laden air moves through the assembly and into the wood flooring, unless otherwise directed by the flooring manufacturer.
 2. **IMPORTANT:** Never use a vapor retarder over a wood subfloor to remedy a known moisture condition, and never install a wood floor over a known moisture condition. A

known moisture condition is one that you are aware of, and could pose future damage to the flooring, the building, or the occupants. It is compulsory practice to always test for moisture regardless of conditions so that any unknown conditions can become known conditions, which then can be handled appropriately. The traditional standard for protecting wood and wood products from rot or decay is to keep the moisture content below 19 percent. Studies have shown, however, that mold growth can occur on wood at moisture content levels above 15 percent, and corrosion of metal fasteners can occur when moisture content exceeds 18 percent. Reaching these moisture content levels does not mean rot, decay, mold growth, or corrosion will occur, but does raise the risk for a potential problem. In all cases, it is important that the installer consult with all involved parties including the manufacturer and customer.

PART III

Vapor Retarders over Concrete Subfloors

- A. Every concrete slab on- and below-grade should have a Class I vapor retarder installed directly beneath it, prohibiting the passage of ground moisture through the slab. If the vapor retarder below the slab has been compromised or left out, moisture will be able to move freely through the slab and into the flooring system. Unfortunately, there is no way of knowing whether there is an intact vapor retarder in place below the entire slab.
- B. Moisture test the concrete substrate in accordance with the most current ASTM standards, to align the moisture control system and installation method with the condition of the slab. All moisture tests give a result "at the time the test was performed" indication, but do not give a permanent condition of the substrate. (See Moisture Testing chapter for more information.)
- C. Install a Class I impermeable vapor retarder when calcium chloride readings are greater than 3 pounds, relative humidity readings are greater than 80%, or calcium carbide readings are greater than 2.5%.
- D. In on- and below-grade applications, due to the ever-changing moisture variability with a concrete slab, and the likelihood of sub-slab moisture barrier degradation over time, a Class I impermeable vapor retarder is always recommended.

- E. Depending upon your installation method, the type of vapor retarder will vary.
 1. Many vapor retarders are designed to be used in conjunction with compatible adhesives. When gluing down a wood floor, only use vapor retarders and adhesive systems that are compatible.
 2. Class I liquid-applied vapor retarders may include rolled- troweled- or sprayed-on sealers, epoxies, or urethanes. Follow the manufacturer's specific instructions on mixing, application, surface preparation, compatibility, moisture control limitations, and warranties.
 3. Class I underlayment sheet-good vapor retarders may include 6-mil polyethylene film or other premium polymer sheet goods, closed-cell foam pads, or peel-and-stick membranes. These sheet-goods must be laid flat on the subfloor, covering the entire surface, with no holes or penetrations. Follow the manufacturer's specific instructions on application, moisture control limitations, and installation methods.
 4. Multi-layer systems include using two layers of fabric membrane such as fiberglass mats, or asphalt-saturated felt or kraft paper. The first layer is adhered to the slab in a skim coat of an appropriate cold-stick asphalt-mastic or hot-mop adhesive, and the second layer is adhered to the first layer using the same fabric and adhesive.

PART IV

Vapor Retarders over other Substrates

- A. Wood Subfloors over Concrete
 1. The vapor retarder should be placed over the concrete slab and underneath the wood subflooring. Follow the methods as listed in the Vapor Retarders over Concrete Subfloors section prior to installing any wood subfloors system over the concrete.
 2. With adequate moisture control over the concrete substrate, and below the wood subfloor system, there is no need for a vapor retarder over the wood subflooring.
- B. Screed/Sleeper Systems
 1. Follow the methods as listed in the Vapor Retarders over Concrete Subfloors section prior to installing any screed/sleeper system over the concrete.
 2. Where lightweight concrete mix or gypsum-based topping compounds have been poured over the subflooring system and between

the screeds, a large amount of moisture is introduced to the screeds/sleepers from this process. Check the moisture content of the screeds/sleepers as well as the lightweight concrete or gypsum-based topping as directed by the applicable manufacturer. Once the moisture levels are within acceptable range, use of a Class II vapor retarder may be used.

C. Radiant Heat Systems

1. Due to the variety in the types of substrates of which radiant heating systems may be a part, follow the methods as listed in the applicable subfloor section.

D. Existing Floors

1. When installing over an existing floor covering such as ceramic, terrazzo, slate, and marble that have been installed over concrete, a class II vapor retarder may be necessary.
2. When installing over an existing wood floor, follow the methods as listed in the Vapor Retarders over Wood Subfloors section prior to installing any new wood floor.
3. When installing over an existing floor covering such as vinyl, linoleum, adhered cork, or resilient flooring, no vapor retarder may be necessary.

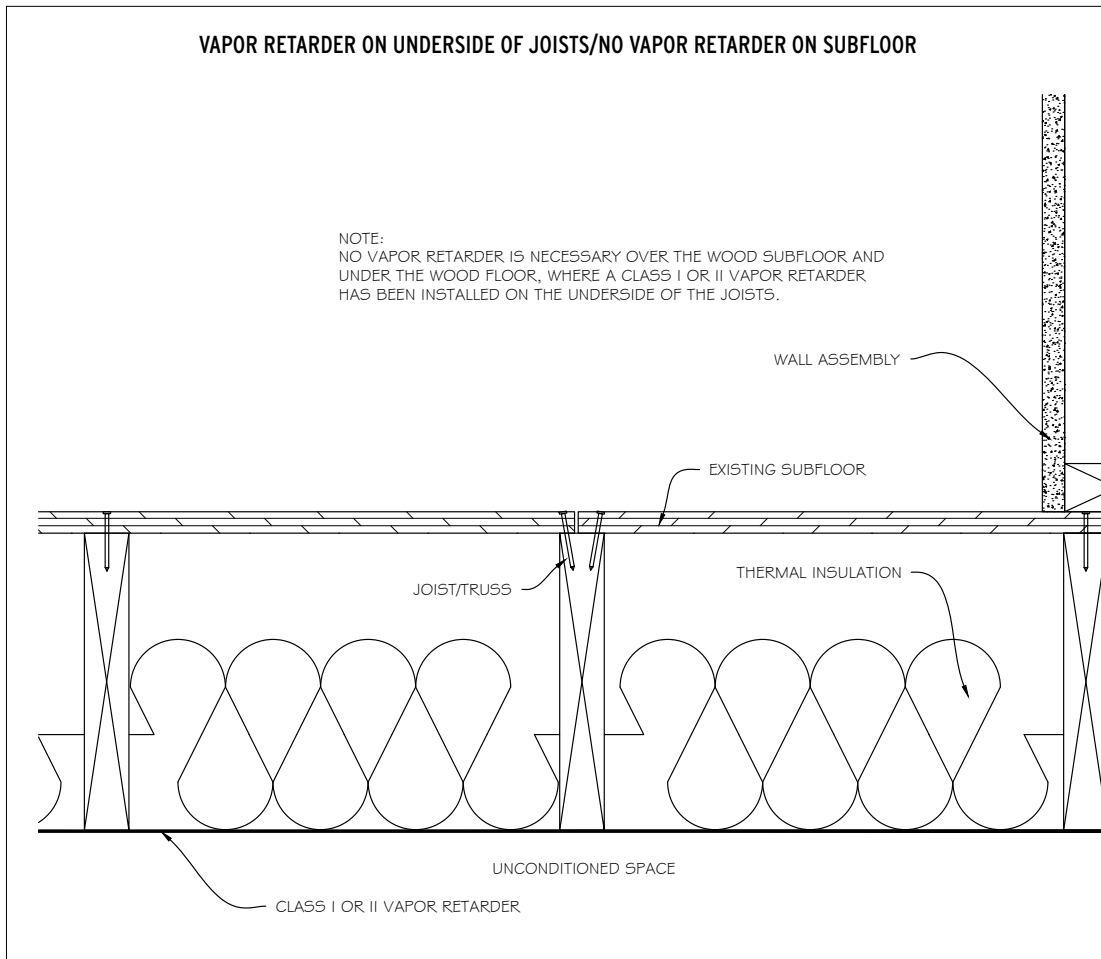

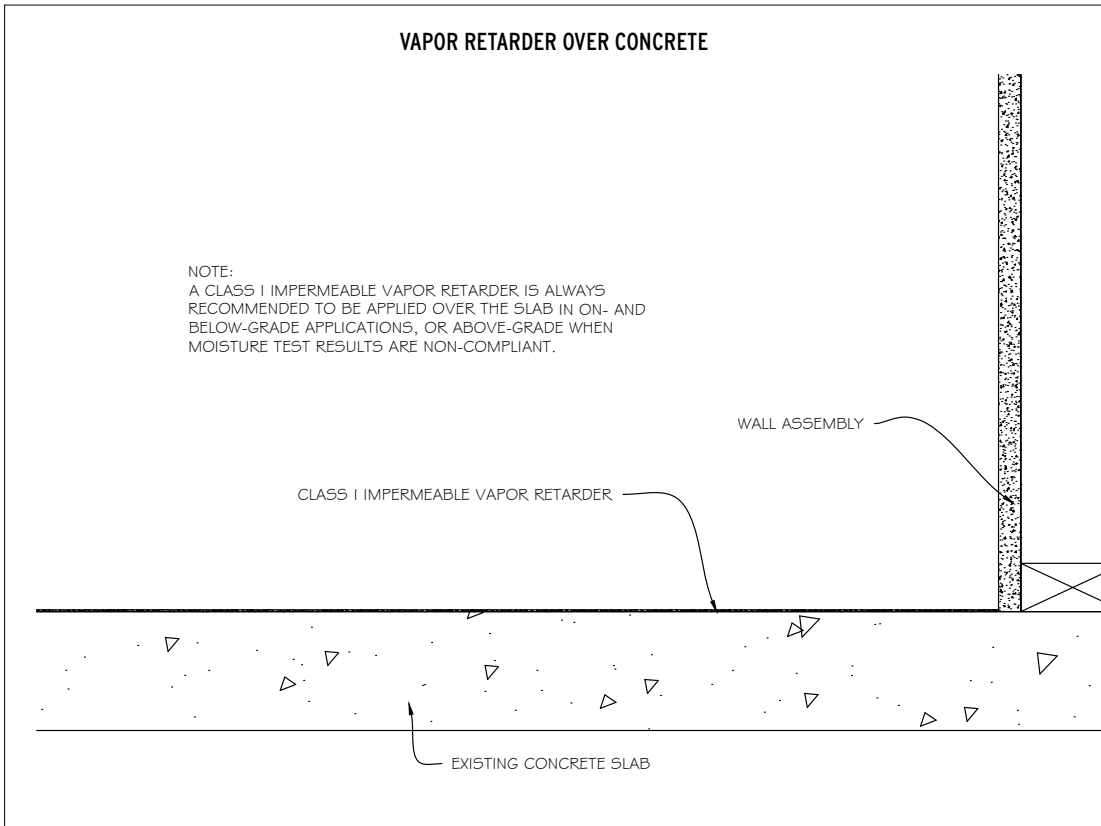
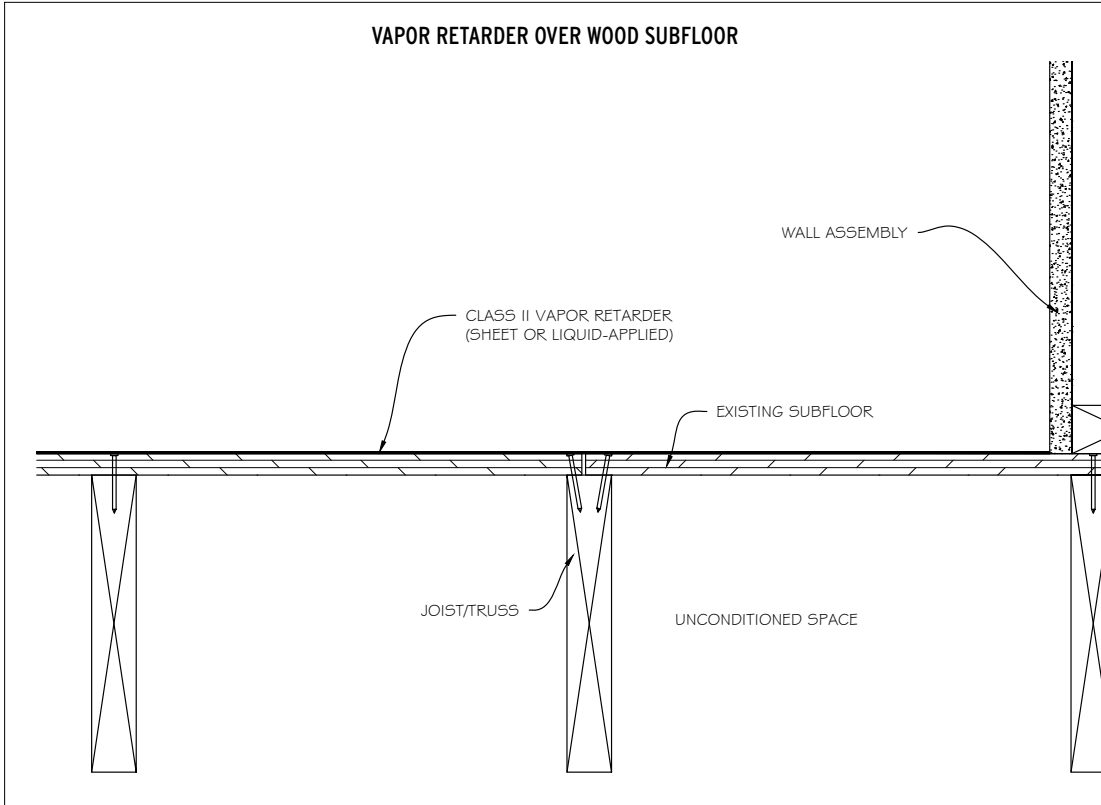

UNDERLAYMENTS: Sound Control/Acoustical

Sound Control/Acoustical Underlayment: An underlayment material commonly used below wood flooring designed to control sound transmitted from or through the floor/ceiling assemblies.

PART I Sound Ratings

- A. Sound Ratings: In North America, there are two primary ratings used for sound control. They are Impact Insulation Class (IIC) and Sound Transmission Class (STC).

1. **IIC**, which stands for Impact Insulation Class, is a statistical measurement of the transmission of impact sound energy through a floor/ceiling assembly system (such as footsteps, dropped articles, or furniture moving across the floor). The larger the number, the more sound attenuation you have. The scale, like the decibel scale for sound, is logarithmic. IIC is measured and stated in accordance with ASTM E989 & C634, and is tested via ASTM E492.



- a. Delta (Δ) IIC is derived by subtracting the IIC of the nominal 6" bare concrete from the IIC of the various tested assemblies. The higher the Delta IIC, the higher the performance level. Delta IIC is derived from ASTM E2179, the Standard Test Method for laboratory measurement of the effectiveness of floor coverings in reducing impact sound transmission through concrete floors.
- b. FIIC, Field Impact Insulation Class, refers to testing procedures conducted in the field following ASTM E1007 and E989. The FIIC test is conducted by setting up testing equipment in the field where sound is not as controllable.
- c. AIIC, Apparent Impact Insulation Class, refers to testing procedures conducted in the field following ASTM E1007. For these metrics, sound power from

associated support structures are attributed to the floor-ceiling assembly. Because these are measures of the apparent performance of the nominally separating floor-ceiling, the receiving room shall be the space directly under the tapping machine.

2. **STC**, which stands for Sound Transmission Class, is a rating of how well a building partition attenuates airborne sound (such as voices, radio, or television) in the context of multi-family facilities. STC is measured and stated in accordance with ASTM C634, and tested via ASTM E90, E336, and E596. STC values are influenced by the solid mass of the structure, but are also dependent on isolation and resilience within the structure.



- a. FSTC, Field Sound Transmission Class, refers to testing procedures conducted in the field following ASTM E1007 and E989. The FSTC test is conducted by setting up testing equipment in the field where sound is not as controllable.
- B. It is important to understand what these ratings mean as they relate to flooring selection and the installation method. A number of factors contribute to a room's sound insulating ability:
1. Floor/ceiling/wall construction and room size and shape.
 2. Interior décor, such as wall hangings and curtains, and finishes and furnishings such as chairs, sofas, tables, and rugs.
 3. Choice of floor covering material.
 4. Use of a flooring underlayment.
- C. The cumulative effect of all these components is what provides the final sound characteristics of the space. No single component can fulfill the requirements for building requirements, which consider the effects of the sum of these components.

PART II Acoustical Products and Systems

- A. Acoustical underlayments are especially important when specifying and installing wood floors for multi-level structures like apartment buildings, condominiums, or within commercial facilities.
- B. The use of acoustical underlayments for wood flooring is important for impact sound (IIC rating) such as footfalls, objects dropped on the floor, etc. The type of sound control system used will be dependent on a number of variables, including the type of flooring used, type of substrate, concrete thickness, ceiling suspension, framing structure, and the entire floor/ceiling assembly.
- C. There are a wide variety of materials that are marketed for acoustical properties. Some are systems, and others are specific materials. Noise transfer from floor to ceiling is dependent upon the entire floor/ceiling assembly.
- D. Install the manufacturer-recommended perimeter isolation barrier vertically around all perimeter and vertical obstructions on the entire floor. The perimeter isolation strip must be installed prior to laying the field.
- E. Acoustical underlayment materials may be floated, adhered to the substrate, embedded within the substrate system, or installed below a floated subfloor system.
- F. Acoustical underlayment materials may include cork, recycled rubber or cork/rubber blends, foam pads, recycled cellulose fiber materials, and dimpled or peel-and-stick membranes.
- G. Adhered underlayment manufacturers may require the underlayment to be rolled after it has been installed. Check with the underlayment manufacturer for when, and what type of roller to use.
 
- H. For floating floor installations, any underlayment materials used below a wood floor should have a published compression resistance and density that meets all minimum requirements of the flooring being installed over it. Check with the flooring manufacturer for minimum compression resistance and density requirements.

- I. Some wood flooring adhesives also have acoustical reducing properties. Check with the adhesive manufacturer for proper application methods and acoustical qualities.

- J. Cork, recycled rubber, or cork/ rubber-blend underlayment:



1. Cork, recycled rubber, or cork/ rubber blends normally come in rolls or panels.
2. Install the perimeter isolation strips prior to laying any underlayment material.
3. Install the underlayment against the perimeter isolation strips.
4. The underlayment should cover the entire flooring area without gaps and be securely bonded with all adjoining seams butted together.
5. For floating wood floor installations, the underlayment may be loose-laid or adhered to the substrate as directed by the manufacturer. For glue-down wood flooring installations, the underlayment must be adhered to the substrates. Never nail through cork, recycled rubber, or cork/rubber blended underlayment.
6. Water-based contact adhesives or wood flooring adhesives are most often recommended for glue down installation of tiles or planks. Follow the underlayment manufacturer's instructions on proper installation methods and what adhesive to use.
7. For glue-down wood floor over cork, recycled rubber, or cork/rubber blends, choose a wood flooring adhesive compatible with the underlayment. Follow the specific adhesive manufacturer instructions on application process.
8. For nail-down wood floor installation, the underlayment must be overlaid with the floated subfloor system, as detailed in the Wood Subfloors over Concrete chapter. Be sure not to allow the flooring fastener to penetrate the underlayment.

- K. Underlayment Pads (foam pads, recycled cellulose fiber materials, and dimpled or peel-and-stick membranes):

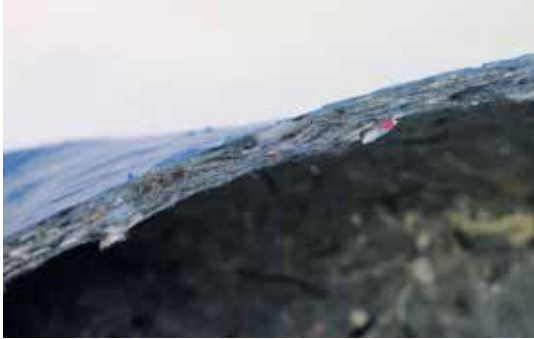

1. Install the underlayment material with the proper side facing down. Follow the underlayment manufacturer's instructions on installation method.
2. The underlayment materials are normally laid with seams butted together. Seal all seams of the underlayment material using a manufacturer-approved tape (impermeable moisture control tape to seal the seams, such as a plastic or foil tape). Many underlayments include double-sided tape to ensure the seams are adequately adhered.
3. For floating wood floor installations, underlayment pads may be loose-laid or adhered to the substrate as directed by the manufacturer. Never nail through underlayment pads.
4. Unless otherwise dictated by the underlayment manufacturer, extend the underlayment a few inches up the wall. Trim excess after the floor has been installed. Note: some products require perimeter isolation strips to be installed prior to underlayment material.
5. For adhered underlayment pads, only use an adhesive as recommended by the underlayment manufacturer that is compatible with the properly prepared substrate.
6. For peel-and-stick underlayments, refer to the wood flooring manufacturer for specific installation instructions.

7. Do not install acoustical underlayment below an engineered wood floor that already has an underlayment attached to it, unless otherwise recommended by the flooring manufacturer.
8. When underlayment material does not provide moisture control, and a vapor retarder is necessary for the installation method, use a Class II vapor retarder below the acoustical underlayment. (Refer to the Underlayments: Moisture Control chapter for more detail.)
9. For adhered underlayment pads, roll the entire floor if required by the adhesive and underlayment manufactures.

PART III Specification

- A. Builders, architects, and specifiers often use lab and/or field tests when specifying floor/ceiling assemblies. Lab tests are a more-accurate model for predicting attenuation performance in a range of different construction types. Field tests are accurate only for the site where the tests were performed. Determine what systems have been specified by obtaining a copy of the Covenants, Conditions, and Restrictions (CC&Rs) for the flooring project prior to bidding on the work.
- B. The protocol for specifying a flooring system is to first determine the IIC, Delta IIC, or STC requirements, then work with the builder, architect, and specifier to identify a flooring and underlayment combination that aligns with the facility requirements. Follow the flooring and underlayment manufacturer installation instructions and ensure the product used is a part of an entire sound control system.
- C. When installing wood flooring in multi-family dwellings, in most jurisdictions, there are minimum IIC and STC values that the floor/ceiling assembly must achieve. It is necessary to take into consideration the building code standards including Uniform Building Code (ICC/UBC) or International Building Code (IBC), both of which call for minimum 50IIC (45IIC if field tested) and 50STC (45STC if field tested) values.
- D. In addition to building code standards, many Homeowners Associations have their own minimum standards written into their CC&Rs, which will supersede, and are often more-stringent than, the minimum building code requirements.
- E. Specification of the proper sound control system with any floor covering change-out/remodel in existing buildings is just as vital in the design-build stages of the project.

PART IV Installation Methods

- A. Installation methods may include floating, glue-down, or nail-down, but each method has its own unique variables to maintain the control of sound.
- B. Each acoustical underlayment system is designed to create an isolation barrier between the installed flooring system and what lies underneath. During installation, avoid hard surface transference points. The floor should not come in direct contact with any vertical obstruction. Some HOAs may have written in their CC&Rs to use acoustical foam in the expansion space as well as acoustical sealant to meet their standard.
- C. The moulding should not come into direct contact with the flooring. A small gap should be left between the moulding and the floor. The moulding fasteners should be driven into the wall, and not into the flooring.
- D. Unless otherwise directed by the flooring manufacturer, never nail through an acoustical underlayment system. Nailing through an acoustical underlayment is not recommended for the following reasons:
 1. Doing so will compromise the specified IIC or STC ratings.
 2. Most of these underlayment materials are not designed to hold a fastener. The fastener withdrawal resistance becomes greatly diminished and will likely result in undesirable noises, movement, or a loosely installed flooring system. The thickness of the underlayments also minimizes the actual subfloor-fastener penetration.
 3. The density of many of these underlayments may allow them to compress when a fastener is driven through, driving the flooring tight to the substrate. This can force the flooring out of a flat plane, and may result in vertical movement and noise within the flooring system. This also creates pivot-points/anchors within the flooring system.

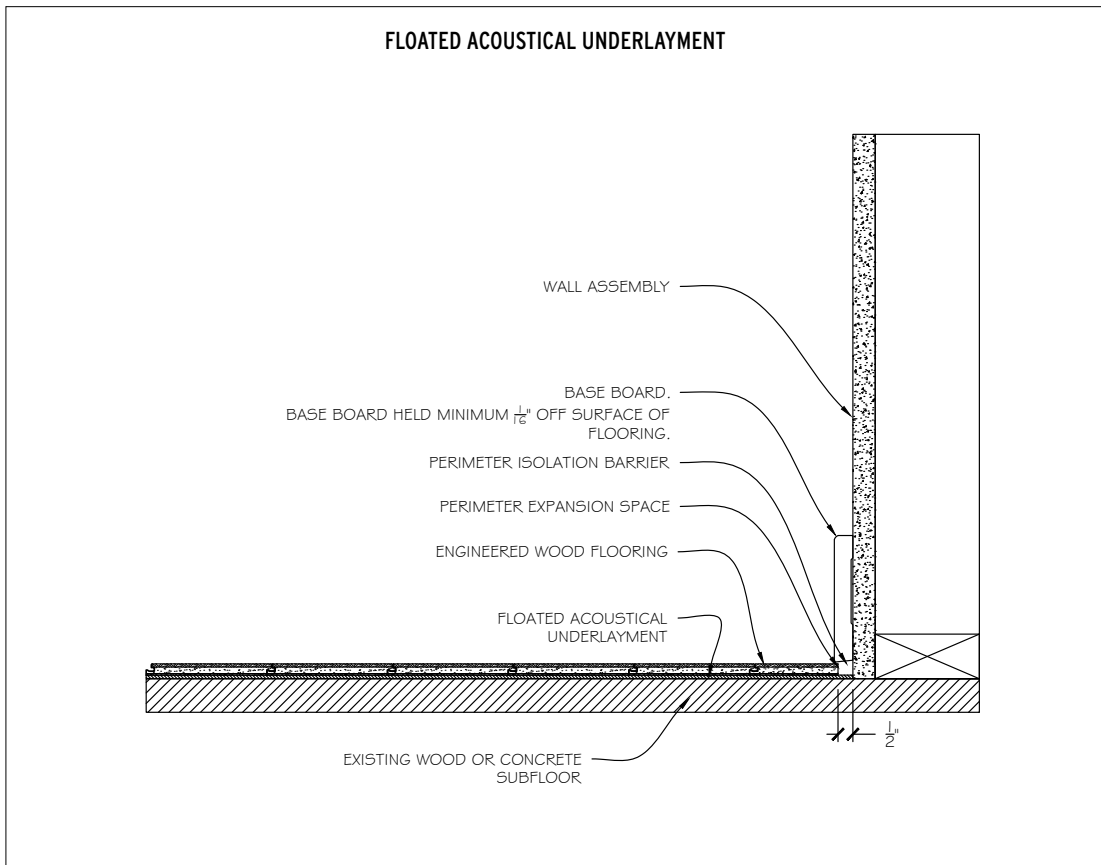

ADHERED ACOUSTICAL UNDERLAYMENT

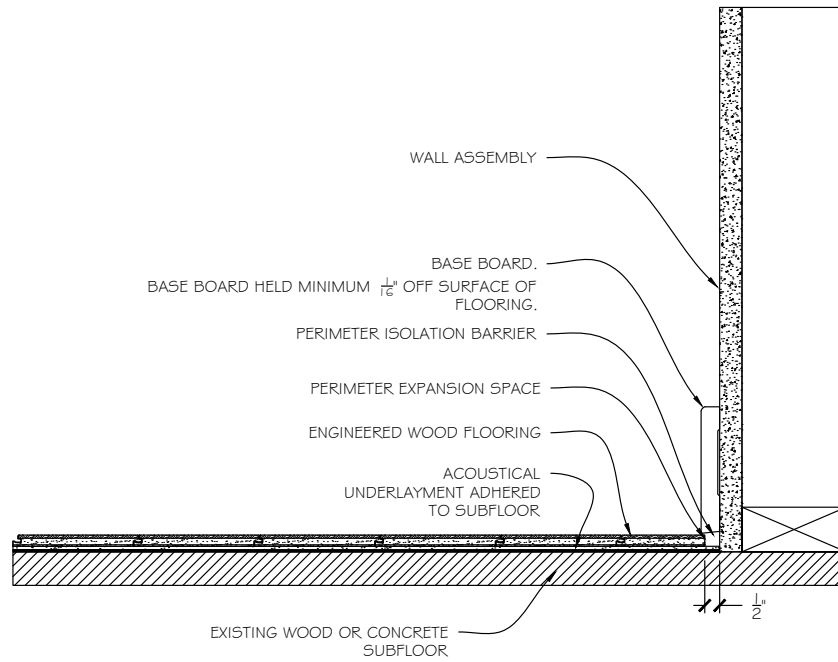

EMBEDDED WITHIN SUBSTRATE

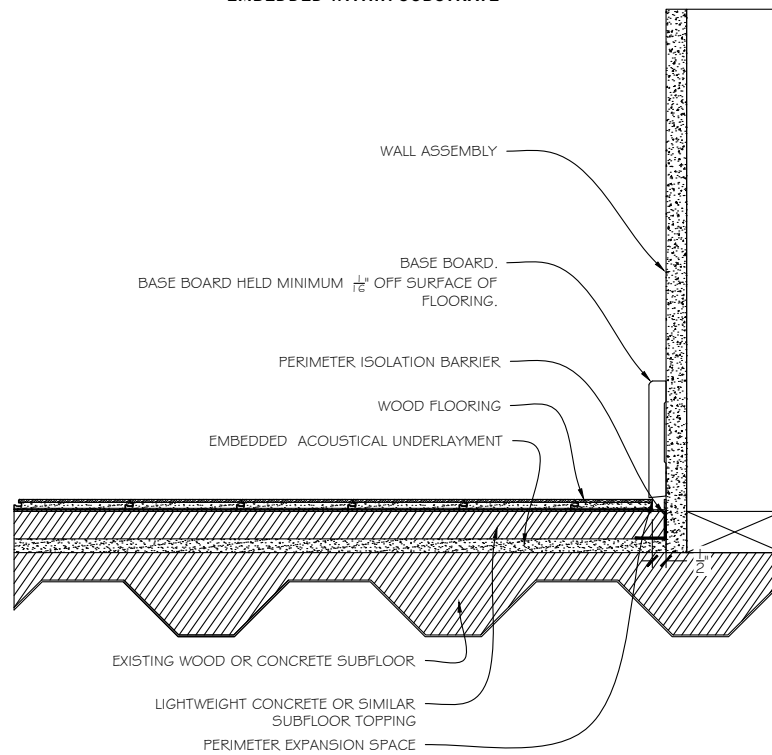

FLOATED SUBFLOOR OVER SOUND CONTROL SYSTEM

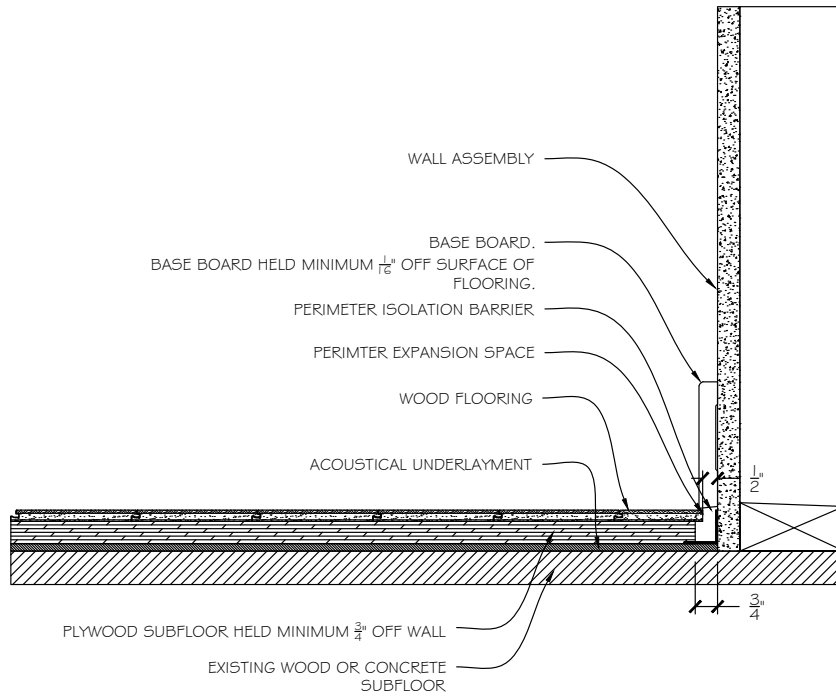

WOOD FLOORING ADHESIVE USED AS ACOUSTICAL MEMBRANE

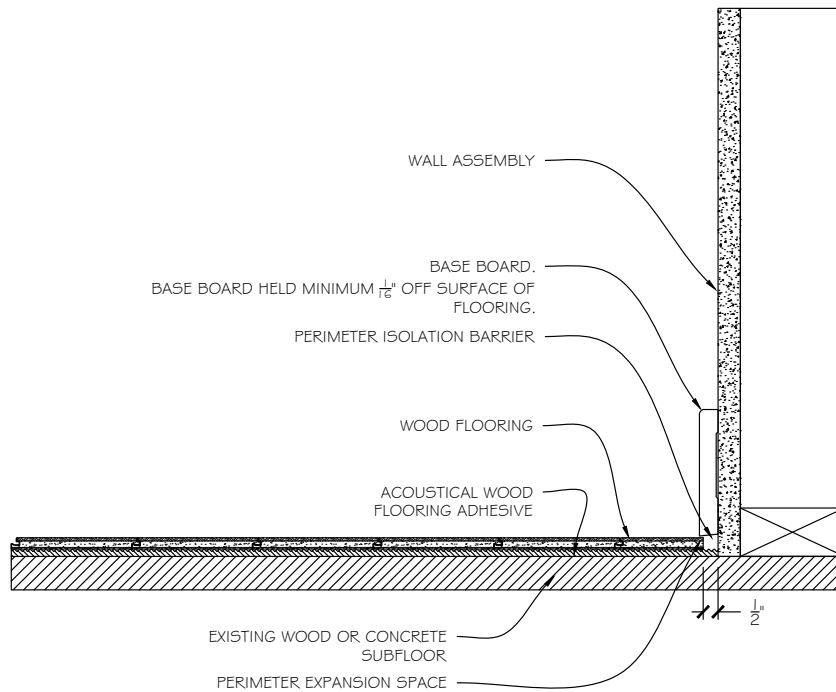

LAYOUT

PART I Working Lines

Working lines are guidelines drawn or marked on the subfloor. Some are critical measurements, such as the primary or secondary lines, while others can be placed as guides to stop nailing or spreading adhesive, or to aid in layout of the different parts of the floor.

- A. Working lines should be measured from the longest, straightest, continuous line in the room.

1. On wood subfloors, measure off of subfloor seams or the longest, straightest, continuous wall in the room to find working lines.
2. On concrete subfloors, measure off of the longest, straightest, continuous wall in the room to find working lines.



- B. A chalk line is a very simple tool that performs an essential task: it provides a perfectly straight line. A chalk line with a fine braided string can leave a much finer line for precision work with less ghosting of the chalk.



- C. Working lines should be identified on the subfloor by using different colors of chalk or by labeling them to avoid confusion between lines.
- D. For working lines that connect to a wall, make a mark on the wall to indicate the line's location in the event that the working line on the subfloor is covered during installation.

- E. To prevent working lines from being erased or worn away, apply a quick-dry aerosol spray poly or lacquer over the lines.
- F. When using a sheet-goods vapor retarder, mark your working lines on the subfloor and then transfer those lines to the secured-in-place vapor retarder.

PART II Trammel Points

- A. Trammel points (bar and compass) consist of two compass points that are mounted



or attached to a beam. They are used in situations where a traditional compass is too small for the area, which makes them ideal for wood flooring. The beam should be a minimum of 4' in length. A longer beam will be beneficial for larger floor spaces.

- B. Trammel points are a simple and accurate method for laying out working lines. They can be used to draw circles or to scribe arcs as reference points for laying out working lines. Attach a pen or pencil to one of the points.
- C. To find center and to square any room for a wood floor layout using trammel points, follow these steps:
1. Measure the width of the room. Measuring from the same wall at opposite ends of the room, measure the width of the room and divide the width by two to find the center-point. Mark these points on the subfloor.
 2. Adjust the centerline where necessary to promote a visually attractive layout. Oblique adjustments to compensate for unsquared walls or other permanent fixtures are sometimes necessary. Parallel adjustments to off-center focal points (window, door, or fireplace) are sometimes necessary as well. These conditions should be discussed with the end-user/builder before continuing the installation.
 3. Snap a line across the length of the room, connecting the center-point marks. This line is your primary line.

4. Measure the length of the primary line and divide by two to find the center-point. Mark this point on the subfloor. This point is now the center point of the room (point "C").

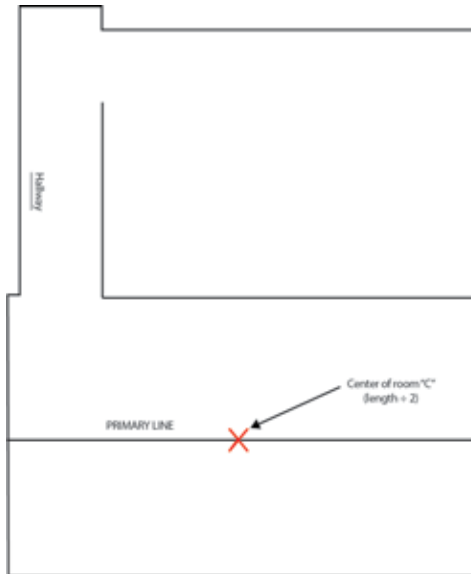

5. Place the trammels at a distance approximately half the length of the beam you are using.
6. Place one trammel point end (to remain fixed in position) on point "C". From point "C", use the marking end of the trammel to draw a circle on the subfloor.

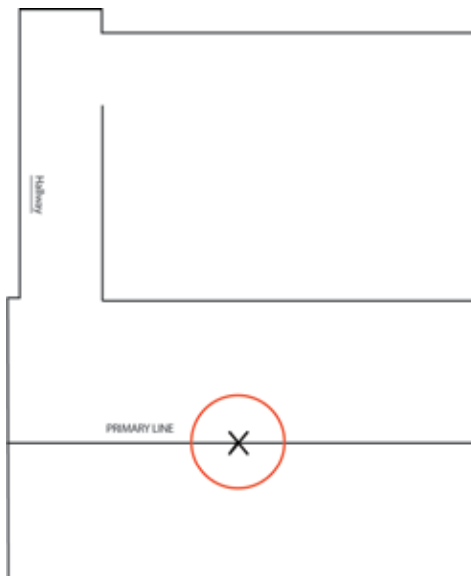

7. Extend the trammel point distance on the beam by approximately 40% (if possible).
8. Place the trammel point end at one of the locations where the circle intersects the primary line. Use the marking point of the trammel to draw an arc above and an arc below the primary line, as near to perpendicular to the center mark point "C" as possible.

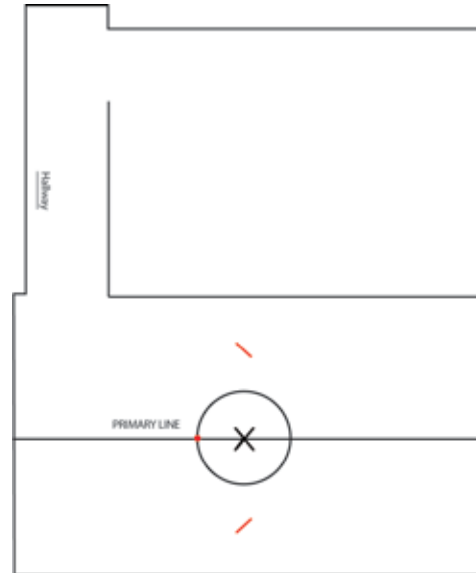

9. Move the trammel point end to the opposite location where the circle intersects the primary line. Use the marking point of the trammel to draw an arc above and an arc below the primary line, as near to perpendicular to the center mark point "C" as possible, crossing the marks made in the previous step.

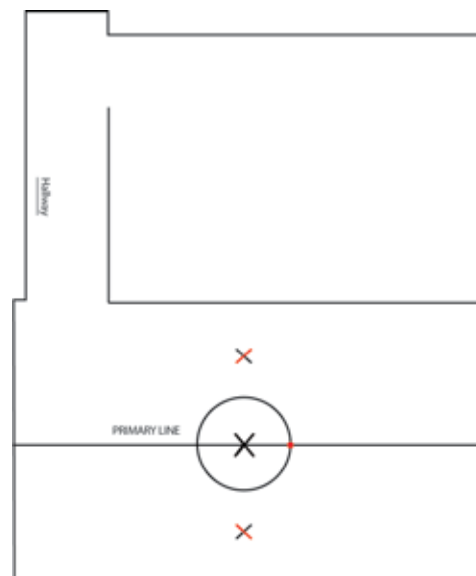

10. Snap a line across the length of the room, perpendicular to the primary line, connecting the marks. This line is your secondary line, and should be perpendicular to the primary line.

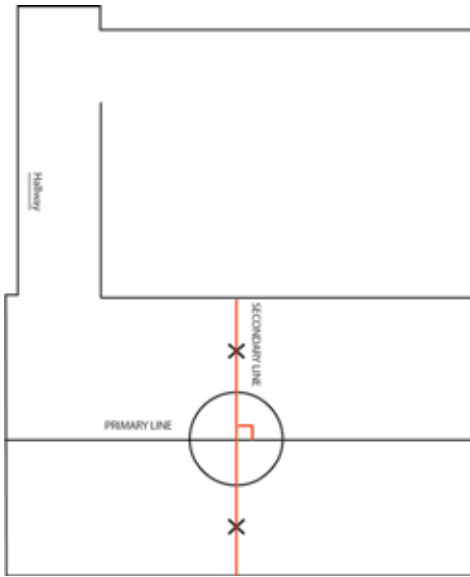

- D. You can also square a room or check that your lines are perpendicular by using the 3-4-5 rule.

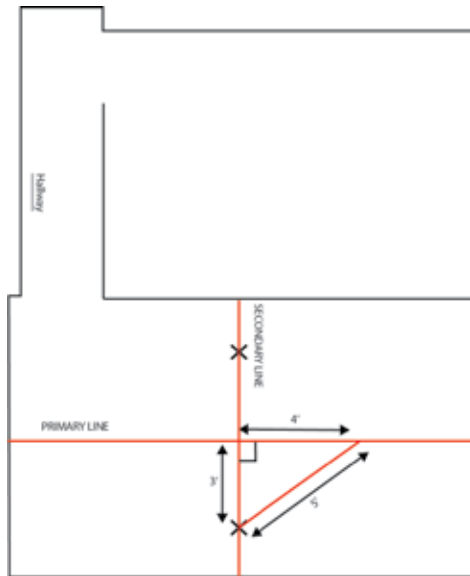

1. **3-4-5 rule:** This rule says that if one side of a triangle measures 3 and the adjacent side measures 4, then the diagonal between those two points must measure 5 in order for it to be a right triangle.
2. It doesn't matter which unit of measurement you use, as long as you keep it the same for all three sides. It can be 3-4-5 feet, 6-8-10 meters, or any multiple of 3-4-5.

PART III Transferring Lines

- A. Transfer the lines by using the trammel points at locations along the primary or secondary lines that can allow you to extend the working lines through doorways and into other rooms. Or measure off of the primary or secondary line to determine new working lines that may be extended.

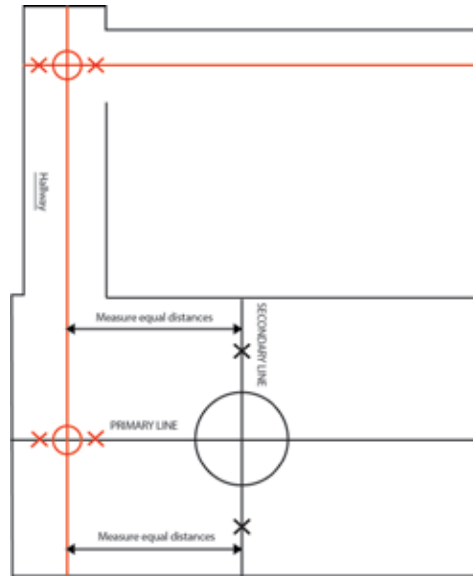

- B. Use the same method to square adjoining room with perpendicular lines. Complete this process for each room receiving wood flooring.
- C. It is important to not wait until the end to verify lines. If you are off on the first secondary line and then move that to adjoining rooms without verifying, then the lines will be wrong in all rooms. Laying out working lines will help guide the installation.

PART IV 45° Angles

To create perfect 45° angle lines for diagonal installations, asymmetrical layouts, or for patterned floors, using trammel points:

- A. Extend the trammel points on the beam to dissect each quadrant using the same method as detailed in the Trammel Points section.

- B. Snap a line that bisects (divides in half) each quadrant. This bisecting method can be repeated again and again between any 2 adjacent radial lines (emanating from a common point) to divide the angle the two lines make, in half.

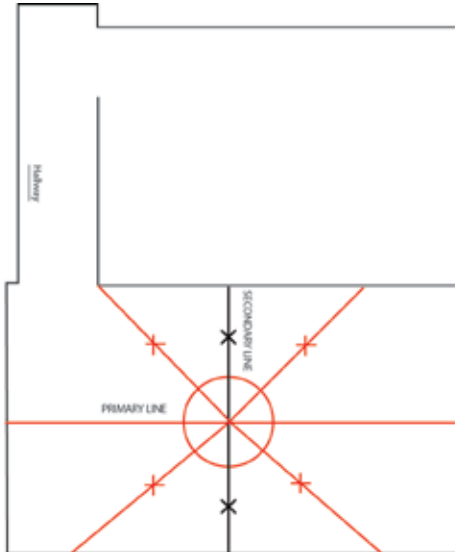

PART V Wall-Layout

- A. Choose a starting wall according to the most aesthetically or architecturally important elements in the room, taking into consideration doorways, fireplaces, cabinets, and transitions, as well as the overall squareness of the room. The starting wall will often be the longest unbroken wall in the room.
- B. Transfer the working line back to and parallel with the starting wall, allowing necessary expansion space between the starting wall and the edge of the first strip or plank run.

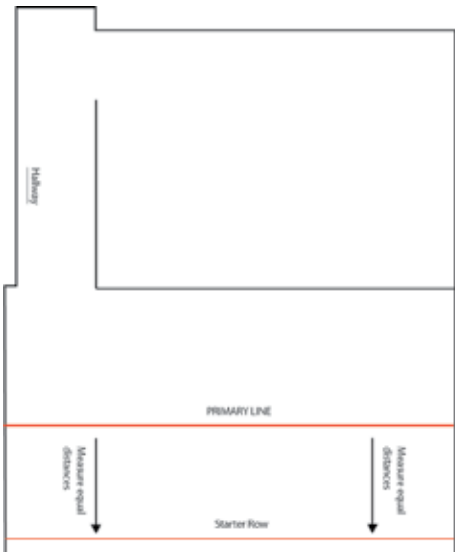

- C. Prior to installing the flooring, secure a straight edge (starter board) inside the chalk line to act as a guide and to prevent the row of planks from shifting during installation. The straight edge could be a straight piece of lumber or piece of flooring. This is temporary and will be replaced as the floor is completed.
- D. Lay one row of flooring along the entire length of the working line, proceed with the installation.

PART VI Center-Layout

- A. Beginning the installation from a center-point in the room allows for the installation to progress in two opposite directions.

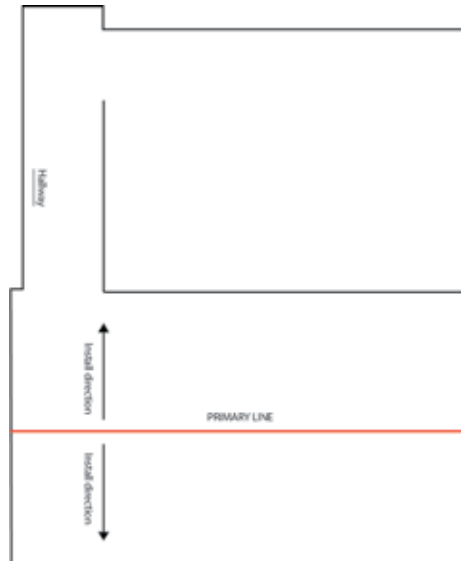

- B. Find the center of the room, square the floor and snap a line down the center of that room.
- C. Install a starter/backer board along the line. Fasten the starter/backer board to the subfloor using an appropriate fastening mechanism (wood subfloors may be screwed; concrete subfloors may be set with temporary adhesive or pressure-sensitive tape).
- D. Install the first row of wood flooring against the starter board, being careful not to move the starter board when nailing. Generally, the groove of the flooring should be against the starter board.

- E. Use the appropriate installation method to install several rows of wood flooring. Use the installation methods detailed in the appropriate section, and per manufacturer instructions.
- F. After installing in one direction, remove the starter/backer board.
- G. Install a spline or a slip tongue in the groove of the board that was against the straightedge. Put wood flooring adhesive down the entire length of the groove before installing the spline.
- H. To keep the spline in alignment for the next flooring board, use a scrap piece of wood flooring to run along the length of the spline.
- I. Install the remaining rows in the opposite direction. Use the installation practices as necessary for the flooring being installed.
- J. Runs of flooring should generally be installed straight. Unless otherwise required, the installed wood flooring should not deviate from a straight line more than 3/16" in 10'.

- C. General guidelines for using a laser as a layout tool:
 - 1. Designate a location flat on the floor within the room.
 - 2. Place laser targets and align the laser to target both marks.
 - 3. The width of the laser line changes with increased distance. Accuracy can be affected by any increase in distance measurements.
 - 4. Mark lines onto the floor accordingly and snap chalk lines.
- D. Not all lasers can establish diagonal lines. To establish a diagonal working line, trammel points or the method described in the following section, "Diagonal Layout," can be used.

PART VII Lasers

- A. Caution when using any lasers. Never stare directly at, or direct a laser beam toward any persons or animals, as doing so can lead to serious eye injury or blindness. Read and understand all safety precautions and proper usage of any laser-producing tools.
- B. Laser-layout tools can assist in accuracy and speed in floor layout. Most laser layout tools have a primary beam line and a perpendicular beam, and often incorporate a 45-degree beam, as well. More-advanced lasers also have lights to align floor layout to tray ceilings, chandeliers, and other features above the floor.



INSTALLATION METHODS:

Nail-Down

Many types of floors can be nailed down in many different situations. No matter the specific job requirements, there are several items that need to be addressed and followed during each installation. When available, the flooring and nailer manufacturer's instructions should always be followed. This includes all recommendations and requirements that give instruction on preparation, installation, or use of the wood floor. Where manufacturer instructions are unavailable, lack information, or they reference NWFA Guidelines, use the following information.

PART I

Substrate Requirements

- A. Wood flooring may be nailed down over most wood subfloors (except particleboard), as long as they meet the minimum requirements as detailed in the Wood Subfloors chapter.
- B. Inspect the substrate to ensure it meets all requirements for the flooring being installed. This includes:
 1. Type of wood panel subflooring.
 2. Subfloor thickness and floor joist/truss spacing requirements.
 3. Integrity of the subfloor: All substrates must be sound and free from squeaks and vertical deflection.
 4. Flatness: The standard for flatness on a wood substrate with a nail down installation method is $\frac{1}{4}$ " in 10', or $\frac{3}{16}$ " in 6'.
 5. Moisture test the subfloor in relation to the flooring being used. (See Moisture Testing Wood chapter for testing information.)
 - a. When testing for moisture, both the wood flooring and the subfloor should be evaluated.
 - b. **IMPORTANT:** Never install a wood floor over a known moisture condition. A known moisture condition is one that you are aware of, and could pose future damage to the flooring, the building, or the occupants. It is compulsory practice to always test for moisture regardless of conditions so that any unknown conditions can become known conditions, which then can be handled appropriately.
- C. Over solid board subfloors laid on diagonal, install $\frac{3}{4}$ " solid and engineered wood flooring perpendicular to the subfloor board direction or perpendicular to the floor joist/truss direction.
- D. Over solid board subfloors laid perpendicular to the floor joists, install the $\frac{3}{4}$ " wood flooring on a diagonal to the subfloor board and joist direction. For any wood floor less than $\frac{3}{4}$ " thick, for parquet flooring, or where the desired wood flooring direction differs from what is required, these subfloors must be overlaid with a minimum $\frac{19}{32}$ subfloor panel. (Refer to the Wood Subfloors chapter on Double-Layer Subfloor Systems for more detailed information.)

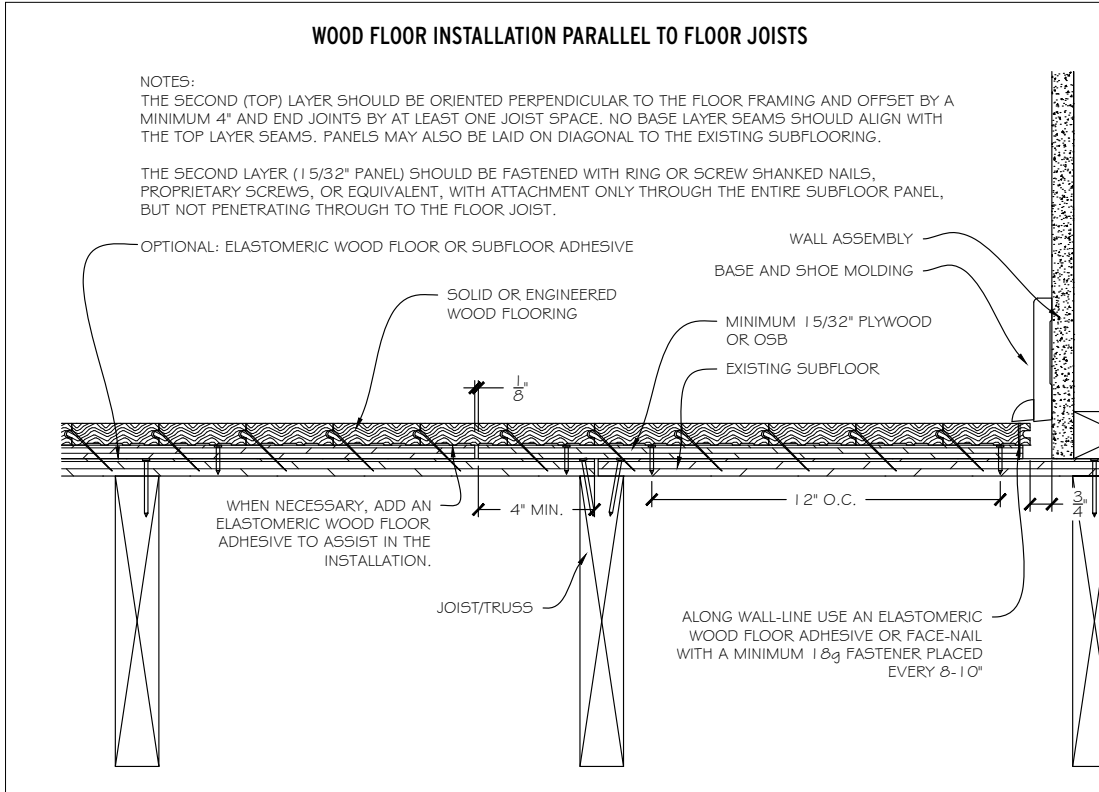

- E. When wood flooring is required to be installed parallel to the floor joists, follow one of these two methods:
1. Add a second layer of minimum 15/32" plywood underlayment to the existing subfloor. (Refer to the Wood Subfloors chapter on Double-Layer Subfloor Systems for more detailed information.)
 2. Brace between joists/floor trusses. This should be completed by a qualified professional.
- F. For nailing directly to screeds/sleepers, refer to the Screeds/Sleepers chapter for more detailed installation methods.

2. Length of wood flooring fasteners may range from 1" to 2½".
3. Fasteners may have a smooth shank or a barbed shank.

B. Cleats

1. Used as the primary fastener, and designed specifically for wood floor installations, blind-nailed through the tongue of the board using manual or pneumatic flooring nailers. 
2. Cleats are designed and cut specifically for the installation of wood flooring. When the flooring/subflooring shrink/swell from season to season, the ribs/barbs engage the wood fibers and thus increase the resistance to withdrawal.
3. Wood flooring cleats are available in different options:
 - a. 16g, 18g, and 20g.
 - b. Lengths ranging from 1" to 2".
 - c. L-cleats and T-cleats, dependent upon the nailer being used.
4. In general, cleats may be driven into the flooring at closer intervals (tighter nailing schedule) than staples, without damage to the tongue of the flooring being installed.

**PART II
Fasteners**

The purpose of the flooring fastener is to hold the wood floor in place through the duration of its' service life. The fastener functions by displacing the wood fibers as it is driven into the board. The pressure exerted against the shaft of the fastener is what provides the fastener retention.

- A. The components of a flooring fastener:
1. Gauge (g) of a flooring fastener is a measure of its diameter. The higher the number, the thinner the fastener.

C. Staples

1. Used as the primary fastener on many wood floor installations, blind-nailed through the tongue of the board using pneumatic flooring nailers.
2. Because each staple penetrates the wood at two points, with two prongs, staples can have a tendency to split the tongues of the flooring when the air pressure from the compressor is set too high for the species being nailed.
3. Staples are available in different options:
 - a. ½" crown staples available in 15.5g.
 - b. Narrow crown (1/4") staples available in 16g-20g.
 - c. Lengths for wood flooring ranging from 1¼" to 2".



D. Cut-nails

1. Like nails made during the 19th century, cut nails are sheared by machine from steel plates, producing a nail with a distinctive wedge shape that ends in a blunt point. It is this particular profile that gives the nail its authenticity. Cut on all sides to produce four edges, they're also called "square" nails.
2. These fasteners historically were used to install wood floors, but mostly are used for decorative purposes today.
3. These nails are manually driven into the flooring.



E. Casing nails

1. Slightly larger than the finish nail with increased holding power, these fasteners are normally hand-driven into the top of the tongue (blind-nailed) or used as a face nail where additional hold power is required.
2. Strong attachment to the subfloor, often not requiring supplemental adhesive.
3. Most-commonly used against pull-up walls.
4. When driven through the face of the board, these nails have a pronounced head that can leave a larger hole in the installed flooring, requiring wood filler.



F. Finish nails

1. A slender nail with a small globular head, used for finish work.
2. Strong attachment to the subfloor.
3. Nails normally are 15g-16g, and up to 2½" in length.
4. Most-commonly used against pull-up walls.
5. These nails normally are used with pneumatic nailers.
6. These nails can leave a larger hole in the installed flooring, requiring wood filler.



G. Brad nails

1. A thin brad of the same thickness throughout, but tapering in width and having a slight projection at the top of one side instead of a head.
2. Brads often require supplemental elastomeric wood flooring adhesive to allow for adequate attachment to the subfloor.
3. Most commonly used against pull-up walls.
4. These nails are used with pneumatic nailers.
5. Brads are typically 18g, up to 2" in length with a smaller head, requiring small amounts of filler.



H. Pin nails

1. A sewing needle-like fastener that is used in fine carpentry to attach two items, often while adhesive is setting up.
2. Pin nails typically are 23g, up to 2" in length, headless pins, often requiring very little, if any, filler.
3. These nails are used with pneumatic nailers.
4. Pin nails are not acceptable fasteners for use with wood flooring unless used in conjunction with an elastomeric wood flooring adhesive.



PART III Fastener Schedules

Different types of wood floors require different flooring nailers, different fastener types, and different nailing schedules. Before beginning the installation, first identify the type of wood flooring being installed and then implement the appropriate, manufacturer-recommended flooring nailer and fastener type. Unless otherwise directed by the flooring manufacturer, the following guidelines should be followed:

- A. Use a flooring nailer specifically designed and adjusted for the wood flooring being installed. Check with the flooring manufacturer for which fastener and nailer is required for the flooring being installed.
- B. The flooring nailer should drive the fastener through the top of the tongue, into the nailing groove/pocket, along the length of the board, with the crown/head of the fastener seated flush, in a way that it is not over-driven or under-driven.



- C. Fasteners placed at intervals less than the required blind-nail spacing requirements are acceptable as long as the tongue and core material of the flooring is not compromised or split during installation.

Standard Fastener Schedules (unless otherwise recommended by the flooring manufacturer)

ENGINEERED T&G WOOD FLOORING (< 5/8" THICK)

NOTES:
FASTENER SPACING: 3"-4" INTERVALS ALONG LENGTH OF EACH BOARD.
1"-2" FROM EACH END-JOINT OF EVERY BOARD.
MINIMUM 2 FASTENERS PER BOARD.

ENGINEERED WOOD FLOORING (< 5/8" THICK)

18g-20g CLEAT OR NARROW CROWNED (1/4") 18g STAPLE, NOT LESS THAN 1 1/4" LENGTH.

WALL ASSEMBLY
BASE AND SHOE MOLDING

APPROPRIATE WOOD SUBFLOOR SYSTEM ASSEMBLY

WHEN NECESSARY, ADD AN ELASTOMERIC WOOD FLOOR ADHESIVE TO ASSIST IN THE INSTALLATION.

CLASS II VAPOR RETARDER WHEN NECESSARY.

JOIST/TRUSS

ALONG WALL-LINE USE AN ELASTOMERIC WOOD FLOOR ADHESIVE OR FACE-NAIL WITH A MINIMUM 18g FASTENER PLACED EVERY 8-10"

WOOD FLOORING TYPE	FASTENER TYPE	FASTENER SPACING
Engineered T&G wood flooring <5/8" thick	18g-20g cleat or narrow crowned (1/4") 18g staple. Not less than 1 1/4" length.	3"-4" intervals along length of each board. 1"-2" from each end-joint of every board. Minimum 2 fasteners per board.

ENGINEERED T&G WOOD FLOORING ($\geq 5/8$ " THICK)

NOTES:
 FASTENER SPACING: 6"-8" INTERVALS ALONG LENGTH OF EACH BOARD.
 1"-3" FROM EACH END-JOINT OF EVERY BOARD.
 MINIMUM 2 FASTENERS PER BOARD.

ENGINEERED WOOD FLOORING ($\geq 5/8$ " THICK)

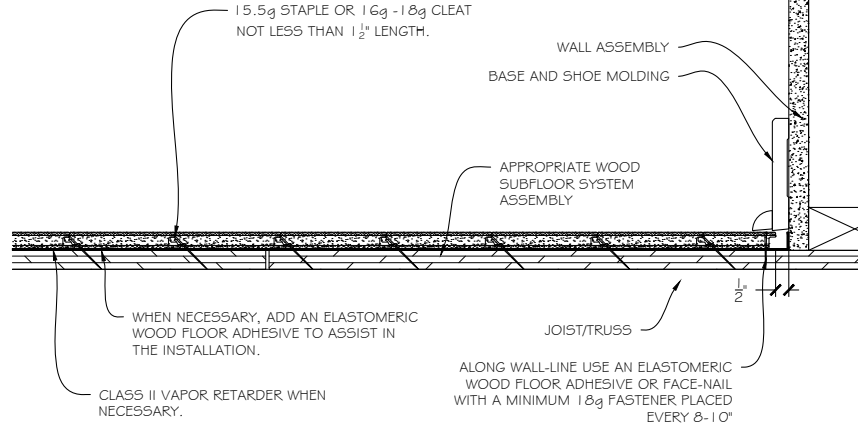

WOOD FLOORING TYPE	FASTENER TYPE	FASTENER SPACING
Engineered T&G wood flooring $\geq 5/8$ " thick	15.5g, staple or 16g-18g cleat. Not less than 1 1/2" length.	6"-8" intervals along length of each board. 1"-3" from each end-joint of every board. Minimum 2 fasteners per board.

SOLID PLANK T&G FLOORING 3/4" THICK (≥ 3 " WIDTH)

NOTES:
 FASTENER SPACING: 6"-8" INTERVALS ALONG LENGTH OF EACH BOARD.
 1"-3" FROM EACH END-JOINT OF EVERY BOARD.
 MINIMUM 2 FASTENERS PER BOARD.

3/4" THICK, SOLID PLANK (≥ 3 " WIDTH) WOOD FLOORING.

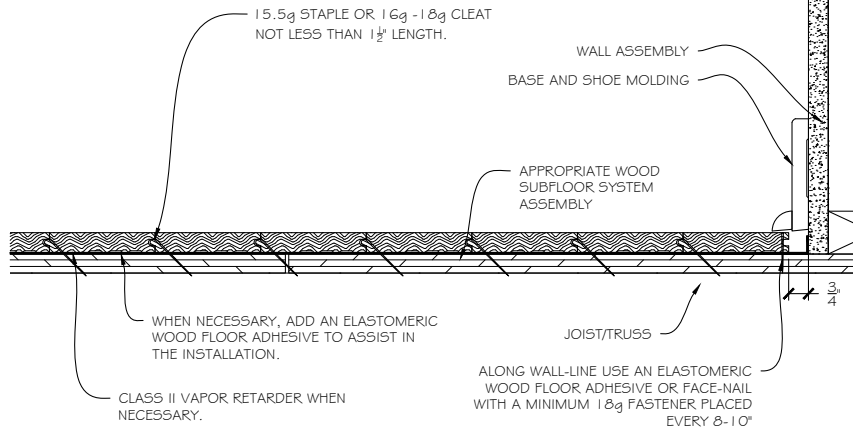

WOOD FLOORING TYPE	FASTENER TYPE	FASTENER SPACING
Solid plank T&G wood flooring 3/4" thick (≥ 3 " widths)	15.5g, staple or 16g-18g cleat. Not less than 1 1/2" length.	6"-8" intervals along length of each board. 1"-3" from each end-joint of every board. Minimum 2 fasteners per board.

SOLID STRIP T&G FLOORING 3/4" THICK (<3" WIDTHS)

NOTES:
 FASTENER SPACING: 8"-10" INTERVALS ALONG LENGTH OF EACH BOARD.
 1"-3" FROM EACH END-JOINT OF EVERY BOARD.
 MINIMUM 2 FASTENERS PER BOARD.

3/4" THICK, SOLID STRIP (<3" WIDTH) WOOD FLOORING.

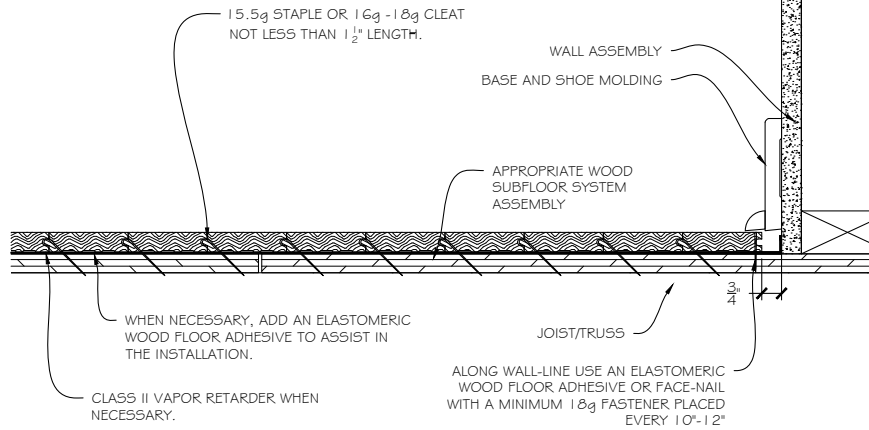

WOOD FLOORING TYPE	FASTENER TYPE	FASTENER SPACING
Solid strip T&G wood flooring 3/4" thick (<3" widths)	15.5g, staple or 16g-18g cleat. Not less than 1 1/2" length.	8"-10" intervals along length of each board. 1"-3" from each end-joint of every board. Minimum 2 fasteners per board.

SOLID STRIP T&G FLOORING >1/2" AND <3/4" THICK (<3" WIDTHS)

NOTES:
 FASTENER SPACING: 6"-8" INTERVALS ALONG LENGTH OF EACH BOARD.
 1"-3" FROM EACH END-JOINT OF EVERY BOARD.
 MINIMUM 2 FASTENERS PER BOARD.

>1/2" AND <3/4" THICK, SOLID STRIP (<3" WIDTH) WOOD FLOORING

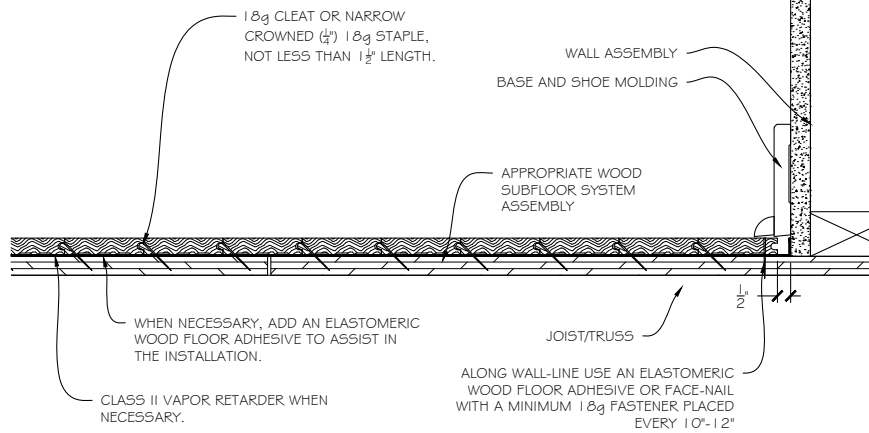

WOOD FLOORING TYPE	FASTENER TYPE	FASTENER SPACING
Solid T&G wood flooring >1/2" and <3/4" thick (<3" widths)	18g cleat or staple. Not less than 1 1/2" in length.	6"-8" intervals along length of each board. 1"-3" from each end-joint of every board. Minimum 2 fasteners per board.

SOLID STRIP T&G FLOORING ≤1/2" THICK (<3" WIDTHS)

NOTES:
 THE SECOND (TOP) LAYER SHOULD BE ORIENTED PERPENDICULAR TO THE FLOOR FRAMING AND OFFSET BY A MINIMUM 4" AND END JOINTS BY AT LEAST ONE JOIST SPACE. NO BASE LAYER SEAMS SHOULD ALIGN WITH THE TOP LAYER SEAMS. PANELS MAY ALSO BE LAID ON DIAGONAL TO THE EXISTING SUBFLOORING.

THE SECOND LAYER (1 5/32" PANEL) SHOULD BE FASTENED WITH RING OR SCREW SHANKED NAILS, PROPRIETARY SCREWS, OR EQUIVALENT, WITH ATTACHMENT ONLY THROUGH THE ENTIRE SUBFLOOR PANEL, BUT NOT PENETRATING THROUGH TO THE FLOOR JOIST.

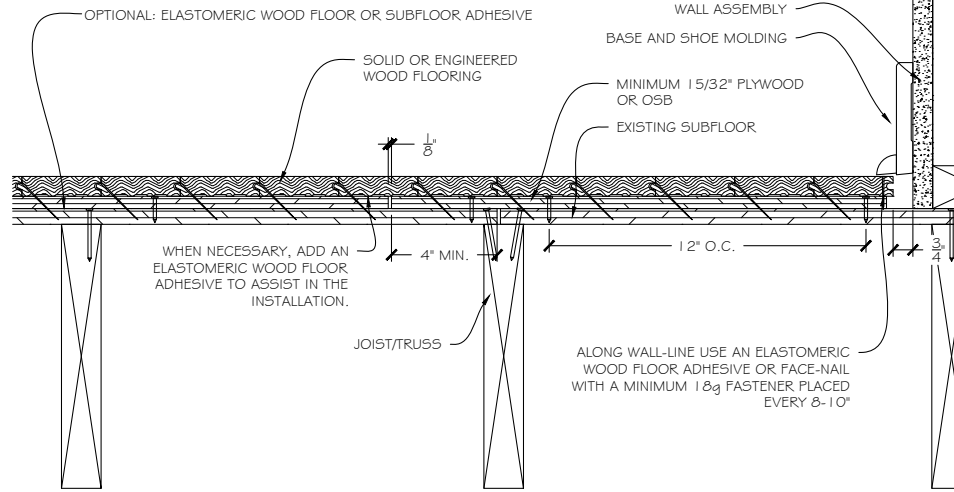

WOOD FLOORING TYPE	FASTENER TYPE	FASTENER SPACING
Solid T&G wood flooring ≤1/2" thick (<3" widths)	18g-20g cleat or narrow crowned (1/4") 18g staple. Not less than 1 1/4" in length.	3"-4" intervals along length of each board. 1"-2" from each end-joint of every board. Minimum 2 fasteners per board.

SOLID STRIP FLOORING TOP-NAIL FLOORING 5/16" THICK

NOTES:
 FASTENER SPACING: 6 1/2"-7" INTERVALS, THROUGH THE FACE OF THE BOARD. ONE BRAD PER INCH-WIDTH OF THE FLOORING MATERIAL. (EX. 2" WIDE BOARD GETS 2 BRADS EVERY 6 1/2"-7")

SOLID 5/16" THICK, TOP-NAIL WOOD FLOORING.

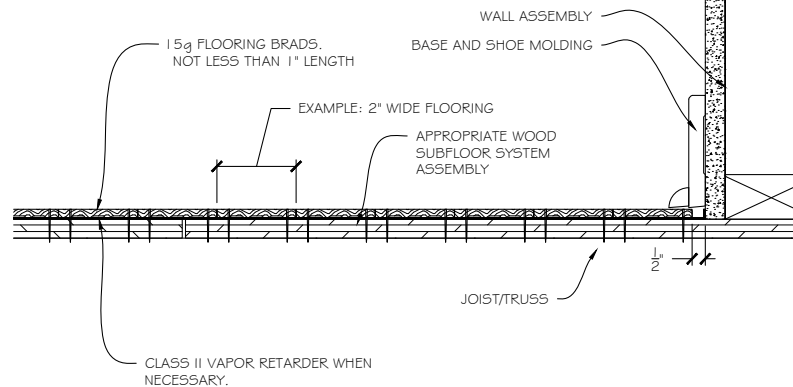

WOOD FLOORING TYPE	FASTENER TYPE	FASTENER SPACING
Solid square-edge top-nail wood flooring 5/16" thick	15g flooring brads. Not less than 1" in length.	6 1/2"-7" intervals, through the face of the board. For every inch of flooring material width, 1 brad should be used (e.g., 2" wide board gets 2 brads every 6 1/2"-7"). Any board width greater than even-inch increments should be rounded up (e.g., 1 1/4" board gets 2 brads every 6 1/2"-7"). Note: For aesthetic purposes, new top-nailed flooring matching up to existing top-nailed flooring should follow the same fastener schedule as currently exists.

- D. Face-nailing may occur where a flooring nailer or finish nailer cannot adequately drive a fastener into the tongue of the board.
1. When face-nailing along starter rows or pull-up rows, use a minimum 18g fastener.
 - a. For solid or engineered strip flooring (<3" widths), face-nails should be placed at 10"-12" intervals.
 - b. For solid or engineered plank flooring (≥3" widths), face-nails should be placed at 8"-10" intervals.
 2. The type of fastener used will dictate the size of the hole left in the face of the board, the amount of necessary filler, and whether adhesive should also be used. To fill face-nail holes, use a wood-filler that matches the overall appearance of the finished wood floor. This is necessary anywhere face-nailing is required.
 3. An elastomeric wood floor adhesive may be used as an alternative to, or in addition to, the use of face-nails on starting and pull-up walls.
 - a. Where flooring adhesive is used as an alternative to, or as an assistant to, the face nail, it may be applied to the subfloor or to the backside of the board itself in a variety of methods, such as the serpentine (sine-wave) pattern, parallel or lengthwise stripes, ends and grooves, or in a full-spread application. Regardless of the application method, the adhesive must cover the entire length and width of each board and be pressed down firmly to ensure the flooring is adhered adequately to the subfloor.
 - b. When using elastomeric wood flooring adhesive along pull-up walls as a primary fastening mechanism, use of an 18g or 23g pin-nail may be used to hold the flooring in place while the adhesive sets-up.

PART IV Nail-Down Installation

- A. Remove any existing base, shoe-mould, or doorway thresholds. These items can be replaced after installation.
- B. Undercut door casings and jambs.
- C. Snap a working line parallel to the starting wall (following wall-layout or center-layout methods), accounting for necessary expansion space.
- D. **Expansion space:**
 1. Maintain proper expansion space based on the material being installed at all vertical obstructions. Unless otherwise directed by the flooring manufacturer, expansion space left between the flooring and vertical obstructions

generally is equal to the thickness of the material being installed. (Example: ½" thick material requires ½" expansion.)

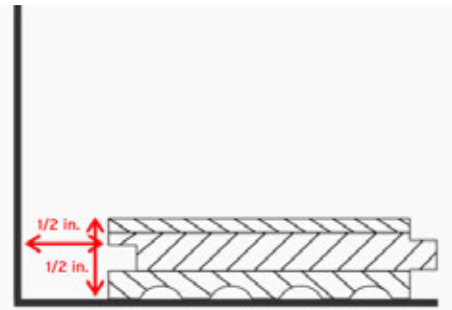

2. To minimize expansion on floor spans wider than 20 feet, spacing between rows (within the flooring system) may be needed, depending on the wood species being installed, climate zone, interior climate controls, and time of year.
 - a. Expansion may be built into the solid wood floor using the dimensional change coefficient (DCC) of the species being installed.
 - b. Determine the DCC of the species being installed (refer to Moisture and Wood technical publication no. A100). Multiply the DCC by the width of the material being installed. Then determine approximately how much you expect the flooring to change moisture content (MC) from one season to the next, and multiply this change in MC by the product of the width and DCC. This will give you an approximation of how much each plank of flooring could expand/contract from season to season. Use this information to determine approximate internal expansion spacing necessary for the long-term performance of the wood floor.
 - c. Example: Red Oak DCC = .00369.
A 5" solid red oak plank that experiences a 4% change in moisture content, may shrink or swell tangentially approximately .0738".
 $.00369 \times 5" = .01845 \times 4\% \text{ change} = .0738"$ of change in dimension.
3. Where additional internal spacing is required with some solid wood floors, use washers, edge trimmer spline, or other removable spacers to leave expansion space within the flooring system. The end-user must be made aware of these built-in spaces prior to installing them in the floor.
- E. Install a vapor retarder as necessary (see Underlayments: Moisture Control chapter for more detail). Transfer working lines onto any affixed vapor retarder being used.

F. Racking:

1. With solid or engineered wood flooring installed over a wood subfloor with a joist systems that meets or exceeds minimum requirements, properly staggered end joints are an appearance/aesthetic consideration only.
2. With 3/4" strip or plank wood floors installed over bare joists, solid board subfloors, "perpendicular car decking," screeds/sleepers, or panel-type subfloor/joist systems that do not meet minimum requirements, the layout of the entire floor, and end joint placement are not only an appearance/aesthetic consideration, but also add a structural element adding rigidity and stiffness to the finished installation.
3. When racking (or laying out the floor) prior to installation, be sure to work from multiple bundles or packages to ensure variation.
4. Flooring warranties typically do not cover materials with visible defects once they are installed. Installation is acceptance of product aesthetic quality.
5. Distribute lengths randomly and pull from multiple bundles.
6. Avoid "H" patterns when possible.
7. Avoid any discernible pattern in adjacent runs such as blatant stair-steps or equal end-joint offsets in sequential rows. Cutting a variety of starter boards from full length boards will assist on "randomizing" joints in products of equal or limited lengths.

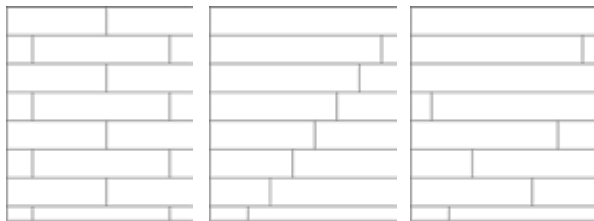

Incorrect **Incorrect** **Correct**

8. End joints of adjacent boards should not be installed in close proximity to each other. In general, end-joint staggering row-to-row should be a minimum of twice the width of the flooring being installed (e.g., 6" stagger for 3" wide material). Wider-width materials may be more-difficult to maintain these staggers due to the product length limitations.

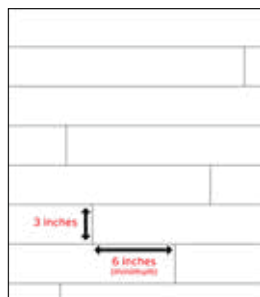

- G. Pre-cut, and lay out a starter row along the entire length of the working line.
- H. Install and adequately secure this as your anchor row. This starter row should be secured to the subfloor to provide a stationary point to be pushed against so flooring doesn't move during installation of the remaining floor. Face-nail only where necessary. Otherwise, blind-nail at the recommended schedule and glue with an elastomeric adhesive.
- I. Runs of flooring generally should be installed straight. Unless otherwise required, the installed wood flooring should not deviate from a straight line more than 3/16" in 10'.
- J. Flooring mallets, tapping blocks, and pull-bars may be used to drive flooring tight during installation. Be certain to only use tools that do not damage the flooring.
- K. Set your compressor to the flooring nailer manufacturer recommended PSI setting for the wood being installed.
 1. When the air pressure from the compressor is set too high for the species being nailed, staples have a tendency to drive the fastener below the nail pocket, potentially splitting the tongues of the flooring, resulting in a less-effective fastener.
 2. When running multiple nailers from one compressor, individual regulators may help regulate the air to each tool.



- L. **Spline/Slip-Tongue:** Spline or slip-tongue is used to maintain T&G within the entire flooring system. Use spline/slip-tongue to fit the specific flooring profile.
 1. Use spline anytime the flooring direction changes, at all headers or flush transitions, and when reversing installation direction such as starting in the center of a layout or back-filling.
 2. To install a spline/slip-tongue:
 - a. Cut to length.
 - b. Apply poly vinyl acetate (PVA)/carpenters glue to the bottom side of the receiving groove.
 - c. Insert the slip-tongue.
 3. Use the groove side of a piece of scrap flooring to secure the slip-tongue while nailing the board into place using the proper nailing schedule for the flooring being installed.

PART V

Glue-Assisted Nail-Down

Where the flooring manufacturer suggests glue-assisted installation or where the glue-assisted installation method is required, some key factors must be addressed:

A. Moisture

1. When using the glue-assist method, you will no longer be able to install a traditional sheet-good vapor retarder. When nailing down wood flooring over a conditioned space that is maintained at the same conditions as the living/interior space, no vapor retarder is necessary. Wood floors installed in these conditions may be nailed with a glue-assist directly to the subfloor without use of a vapor retarder.
2. Where wood flooring is being installed over unconditioned space, use of a liquid-applied, or similar Class II vapor retarder that is compatible with the flooring adhesive may be used to allow for a glue-assist directly to the subfloor.
3. **IMPORTANT:** Never install a wood floor over a known moisture condition. A known moisture condition is one that you are aware of, and could pose future damage to the flooring, the building, or the occupants. It is best practice to always test for moisture regardless of conditions so that any unknown conditions can become known conditions, which then can be handled appropriately.

B. Glue-Assisted Nail-Down Installation Method

1. Where mechanical fasteners on a nail-down installation are the primary installation method, the nailing schedule should remain the same as normal installation for the flooring being installed. The addition of adhesive is not intended as a replacement fastener mechanism, rather supplemental to the mechanical fastener. Where the adhesive is applied using a full-spread application, the fastener schedule is not to be considered the primary fastening method.

2. Due to the reduction in the amount of fasteners used per square foot of flooring width, wide plank (>5" widths) solid and engineered wood flooring should be installed using the glue-assisted installation method, when site conditions allow, unless otherwise recommended by the flooring manufacturer.
3. The adhesive used should be a wood flooring adhesive with elastomeric qualities to allow for normal movement within the flooring system. The adhesive must also be compatible with the subflooring and any liquid-applied vapor retarder system used.
4. The wood subfloor must be thoroughly vacuumed, and free of any debris to ensure adhesion between the subfloor and the wood floor.
5. Test the adhesive to determine the most-effective application method, and for compatibility with the subfloor. The adhesive application method should add supplemental holding power to the installation.
6. The wood flooring adhesive may be applied to the subfloor or the backside of the board itself in a variety of methods to supplement the mechanical fastener.
 - a. With any of the following application methods, use a notch trowel, or apply a continuous, minimum 1/4" wide, uniform bead of adhesive directly to the subfloor, or to the back of the board using a glue gun to dispense the adhesive.
 - b. The adhesive should be applied in a manner that covers the entire width and length of each plank, to within a minimum of 1" from the edges and ends of each board.

c. Listed are a few common methods and applications for each:

SERPENTINE (SINE-WAVE) PATTERN



PARALLEL STRIPES PATTERN



ENDS AND GROOVES PATTERN



LENGTHWISE PARALLEL STRIPES PATTERN



- i. **Serpentine (sine-wave) pattern:** The serpentine (sine-wave) pattern, where the full curve (peak-to-peak) is performed approximately twice the width of the board. The adhesive should cover the entire length and width of each board.
- ii. **Parallel stripes pattern:** The parallel stripes may run perpendicular to, or on diagonal to, the length of each plank being installed. Each stripe should be placed at approximately 6"-8" intervals.
- iii. **Ends and grooves pattern:** Adhesive is applied to the subfloor or to the underside of the board in the location within 1" from both ends of the board and along the full length of the back, groove-side of the board.
- iv. **Lengthwise parallel stripes pattern:** Adhesive is applied to the subfloor or to the underside of the board in the location within 1" of each long side edge and down the middle of the board.

7. **IMPORTANT:** When using a trigger-activated flooring nailer with the glue-assisted installation method, the installer must either stand on the floor, or apply a downward pressure to the surface of each board as it is being nailed. This will ensure the flooring does not lift away from the subfloor causing unnecessary vertical movement or hollow noises.

- C. **Nail-Assisted Glue-Down Installation Method**
 - 1. Glue-down is the primary installation method. The adhesive application should remain the same as normal installation for the flooring being installed (see Glue-Down Installation Methods chapter). The addition of mechanical fasteners is not intended as a replacement fastening mechanism, rather a supplemental method.
 - 2. With full-spread installations over wood subfloors or screeds/sleepers, it is sometimes necessary or helpful to blind-nail the flooring periodically in order to hold the flooring in place while the adhesive sets-up.
 - a. This method may be appropriate where flooring needs to be driven tight during the installation.
 - b. There is no recommended nailing schedule for this method, as the fasteners are strictly used as a supplement to the glue-down method.

INSTALLATION METHODS: Glue-Down

Many types of floors can be glued down in many different situations. No matter the specific job requirements, there are several items that need to be addressed and followed during each installation. When available, the flooring and adhesive manufacturer's instructions should always be followed. Follow the adhesive manufacturer installation instructions specifically for substrate preparation and trowel selection. Where manufacturer instructions are unavailable, lack information, or they reference NWFA Guidelines, use the following information.

PART I Substrate Requirements

Wood flooring may be glued down over many substrates, as long as they meet the minimum requirements as detailed in the applicable chapter. Inspect the substrate to ensure it meets all requirements for the flooring being installed.

- A. Wood Subfloors (refer to the Wood Subfloors chapter for more detailed information).
 1. Inspect the wood subfloor to ensure it meets all flooring and adhesive manufacturer requirements.
 2. Test the wood subfloor material for compatibility with the adhesive being used. (Some types of wood flooring adhesives do not adhere to some high-performance OSB panels.)
 3. Check that the type and integrity of the wood subfloor is appropriate for the wood floor installation. This includes subfloor thickness and joist/floor truss spacing requirements, maximum vertical deflection requirements, and that it is sound and free from squeaks and noises.
4. Flatness: The standard for flatness with glue-down installation methods on a wood subfloor is 3/16" in 10', or 1/8" in 6'.
5. When testing for moisture, both the wood flooring and the wood subfloor should be evaluated and documented (refer to the Moisture Testing Wood chapter for testing information).
 - a. **IMPORTANT:** Never install a wood floor over a known moisture condition. A known moisture condition is one that you are aware of, and could pose future damage to the flooring, the building, or the occupants. It is compulsory practice to always test for moisture regardless of conditions so that any unknown conditions can become known conditions, which then can be handled appropriately. If subfloor moisture becomes a problem after installation, pre-installation moisture testing and documentation will provide a moisture baseline at the time of installation.
6. All solid and engineered wood flooring being glued down over a wood subfloor should be installed perpendicular to, or on a diagonal to, the joist/floor truss direction for any single-layer subfloor.

FULL-SPREAD GLUE-DOWN SOLID WOOD FLOORS OVER WOOD SUBSTRATE

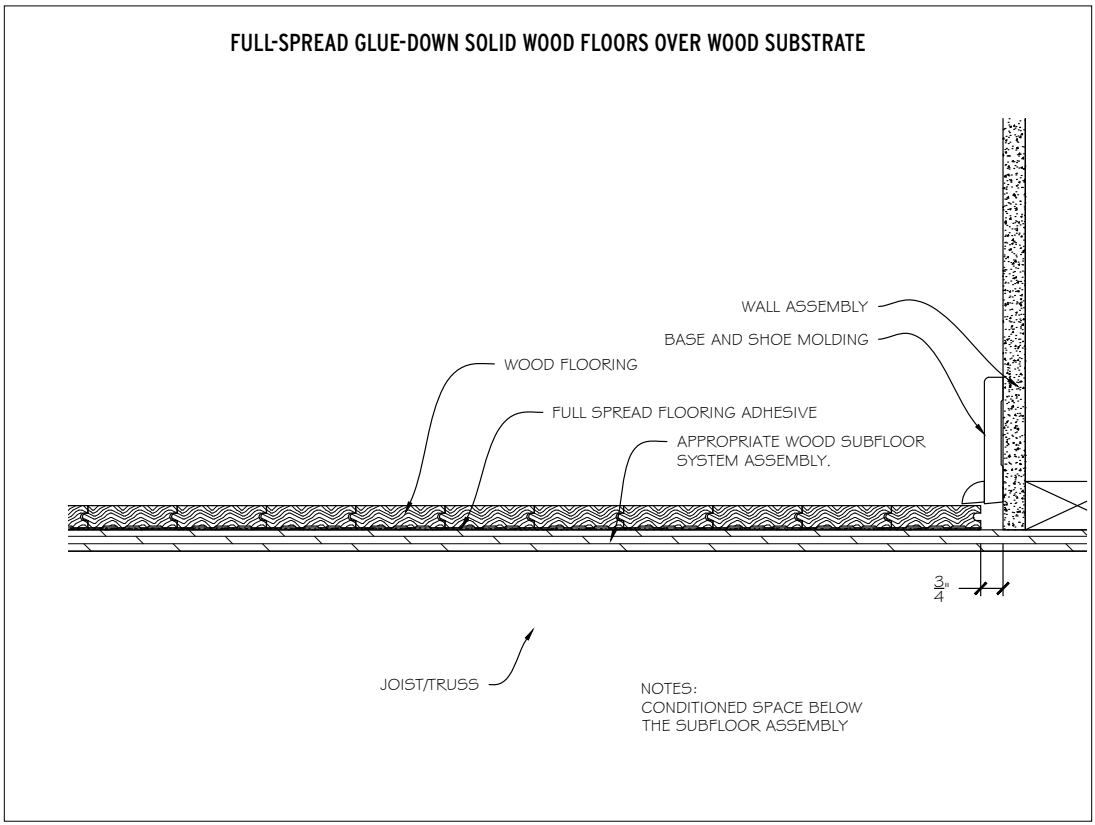

FULL-SPREAD GLUE-DOWN ENGINEERED WOOD FLOOR OVER WOOD SUBSTRATE

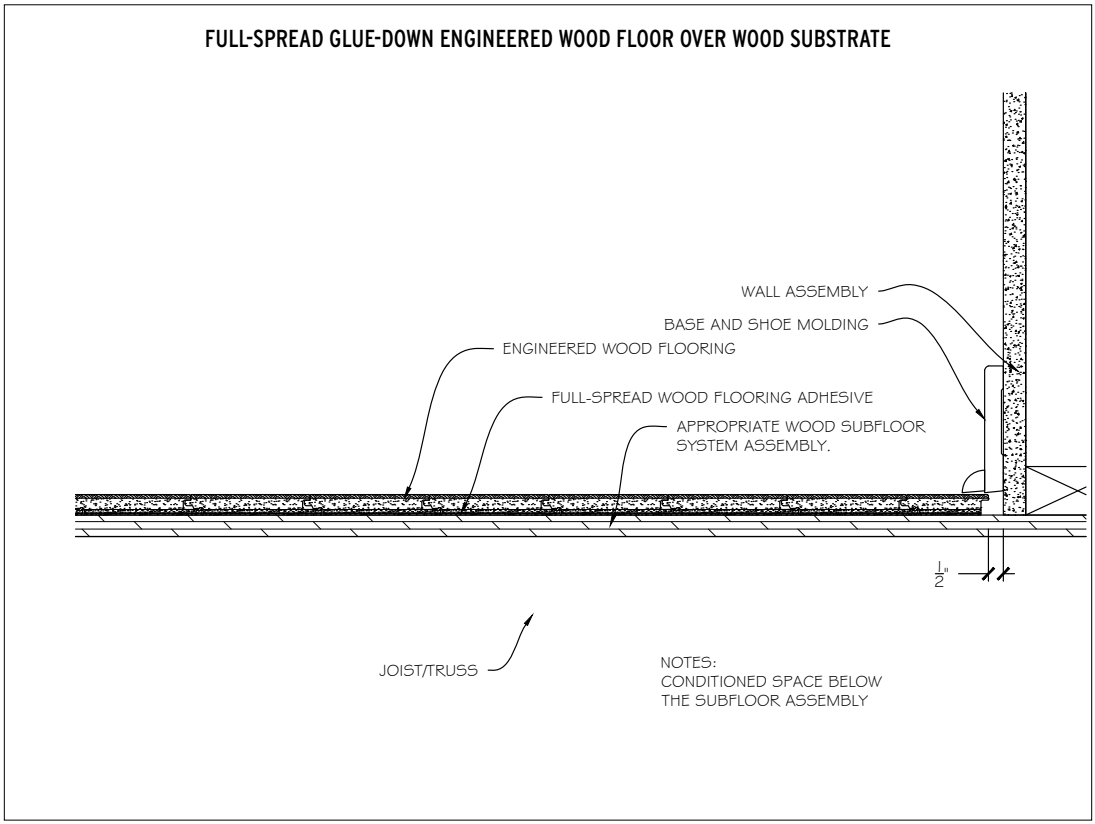

- B. Concrete subfloors (refer to the Concrete Subfloors chapter for more-detailed information).
 - 1. Inspect the concrete subfloor to ensure it meets all adhesive and flooring manufacturer requirements.
 - 2. Address all construction joints on the jobsite. Wood flooring should not bridge these types of joints without allowing for a breaking point. Transitions and/or expansion space should be built into the wood flooring system to avoid potential wood floor damage at these locations in case of future movement.
 - 3. If any subfloor toppings such as self-levelers, skim-coatings, patches, trowelable underlayments, or floor-fills exist, ensure any sealers or adhesive products are compatible with these toppings.
 - 4. Removal of any contaminants that may interfere with the adhesive system is required.
 - 5. Concrete surface profile (CSP): For concrete slabs, the concrete surface profile should be evaluated to ensure it meets the adhesive manufacturer requirements.
 - 6. Porosity: Nonporous substrates may need to be prepared to an adequate CSP. Refer to the adhesive manufacturer for more detail. Porous substrates may require the use of densifiers/hardeners (compatible with the adhesive system being used).
 - 7. Flatness: The standard for flatness for a concrete subfloor with glue-down installation methods is 3/16" in 10' or 1/8" in 6'.
 - 8. Moisture test the concrete subfloor in relation to the flooring being used. Refer to the Moisture Testing chapter for more information. When testing for moisture, both the wood flooring and the concrete subfloor should be evaluated.
 - a. Concrete slabs with a calcium chloride reading of greater than 3 lbs/1,000 sf/ 24 hr are strongly recommended to wait for further drying of the slab, or install/ apply a minimum Class I impermeable vapor retarder over the slab according to the adhesive manufacturer's instructions, prior to installation.
 - b. Concrete slabs with an in-situ RH reading of greater than 80% are strongly recommended to wait for further drying of the slab, or install/apply a Class I impermeable vapor retarder according to the adhesive manufacturer's instructions, prior to installation.
 - c. Always follow the adhesive and the flooring manufacturer's instructions for moisture test methods, limitations, and acceptable control of moisture. The results will help you decide which type of moisture control system will be necessary for the job.
- C. Solid board subfloors (refer to the Wood Subfloors chapter for more detailed information).
 - 1. Unless otherwise directed by the flooring and adhesive manufacturer, do not use the glue-down installation method as the only installation method over solid board subflooring.
 - 2. Minimum 19/32" subfloor panels should be installed as an overlay to achieve a suitable substrate.
- D. Screeds/sleepers (refer to the Screeds/Sleepers chapter for more detailed information).
 - 1. Full-spread glue-down and nail-assisted glue-down installation methods are appropriate over properly prepared screeds/sleepers embedded in concrete, or when screeds/sleepers have been overlaid with the appropriate wood panel subfloor.
- E. Radiant heat (refer to the Radiant Heat chapter for more detailed information).
 - 1. Confirm the adhesive system being used is compatible with the radiant heating system.
 - 2. Reduce or turn off heat during installation of the flooring to avoid loss of open/working time, premature drying, and skinning-over of the adhesive. Check with the adhesive manufacturer for minimum/maximum subfloor temperature limitations during the installation.

PART II Adhesives

Adhesive selection is an important step in a glue-down installation.

- A. When applicable, follow the flooring manufacturer recommendations for which adhesives to use to install the flooring.
- B. Follow the adhesive manufacturer's instructions for proper use of the adhesive.
- C. Characteristics of each adhesive, which affect application methods, include flash-time, working-time, and adjustability-time.
- D. All wood flooring adhesives must be elastomeric, which means they remain flexible and maintain their bond when there is movement in the installed flooring system.
- E. Allow the adhesive to reach room temperature before using, unless otherwise directed by the adhesive manufacturer.
- F. There are several types of adhesives used to install wood floors.
 1. Acrylic adhesives have great tack development, ease of clean-up, and are non-flammable. Acrylic adhesives contain water, which can cause some types of wood flooring to swell or become distorted. They also have limited resistance to alkalinity and slab moisture.
 2. Solvent adhesives are easy-to-apply and easy-to-clean, but are highly flammable and are odorous. For this reason, it is important to extinguish all pilot lights before using solvent adhesives. Check local restrictions for potential constraints for shipping and storing solvent adhesives.
 3. Urethane adhesives are commonly used for wood flooring installations today. They have minimal odor, and are nonflammable. This type of adhesive is moisture-resistant and alkali-resistant, but is more-difficult to clean off of the finished wood surface.
 4. Modified polymers or silane-modified polymer adhesives are solvent-free and isocyanate-free adhesives. They are easy-to-clean and have low VOCs. These adhesives are typically capable of controlling moisture in concrete when applied in a specific, manufacturer-specified method.

5. Multi-functional adhesives: These products save time by eliminating multiple steps in the process, ultimately reducing overall costs. Each product has multiple functions, which may include crack bridging, moisture control, sound control, and mold/mildew resistance. These products are often marketed as two-in-ones, three-in-ones, four-in-ones, etc.

PART III Trowel Selection



- A. Trowel size dictates the square footage coverage of the adhesive.
- B. The trowel selection is dictated by the adhesive manufacturer. Application method may include the angle at which the trowel is used to apply adhesive, or the pattern in which the adhesive is applied to the substrate.
 
- C. It is typically required to occasionally pull boards to check for coverage and adequate adhesive transfer from the substrate to the back of the board. Unless otherwise suggested by the adhesive manufacturer, adhesive coverage should be as follows:
 1. For moisture control, 100% substrate coverage and adhesive transfer is normally required for solid wood flooring product, >95% substrate coverage and adhesive transfer is required for all other wood flooring.
 2. For bonding only, check coverage to ensure there is a minimum of 80% substrate coverage and adhesive transfer for engineered, and >95% for all solid wood flooring.

D. Do not use old or worn-down trowels, as the notches wear down with normal use, consequently decreasing the flow rate of the adhesive.

E. Depending on the application and product being used, the profile of the trowel will be designated for a very specific purpose. Some of the qualities that designate a trowel include the shape and dimensional specifications of the trowel:

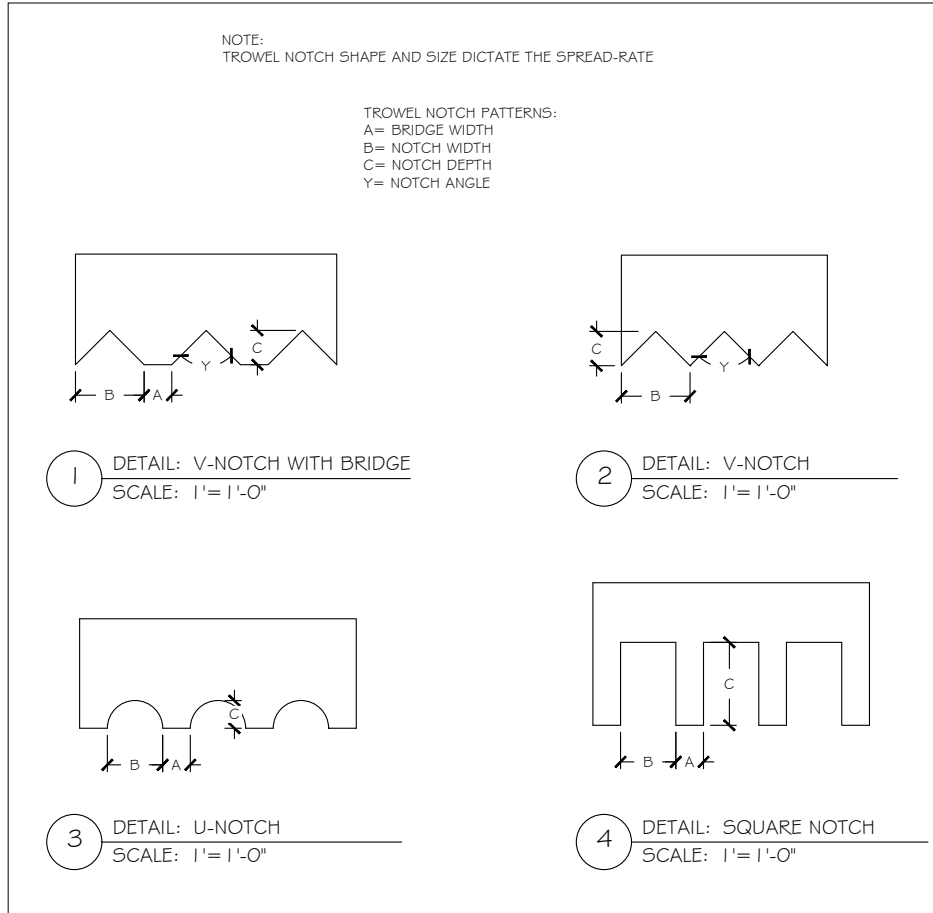

PART IV Glue-Down Installation

- A. Solid and engineered strip, plank, parquet, or end-grain wood flooring may be glued down.
- B. Where possible and practical, begin the installation at a point opposite of the point of egress in order to minimize walking across a newly glued-down installation. Wall-layout option is the most appropriate for glue-down installations. Refer to the Layout chapter for more-detailed information.
- C. Undercut door casings and jambs. Remove any existing base, shoe-mold, or doorway thresholds. These items can be replaced after installation.
- D. Snap a working line parallel to the starting wall, accounting for necessary expansion space.

E. Expansion space

1. Maintain proper expansion space based on the material being installed at all vertical obstructions. Unless otherwise directed by the flooring manufacturer, expansion space left between the flooring and vertical obstructions is generally equal to the thickness of the material being installed.
2. To minimize expansion on floor spans wider than 20 feet, spacing between rows (within the flooring system) may be needed, depending on the wood species being installed, climate zone, interior climate controls, and the time of year.
 - a. Expansion may be built into the solid wood floor using the dimensional change coefficient (DCC) of the species being installed (refer to Moisture and Wood technical publication no. A100).

- b. Determine the DCC of the species being installed. Multiply the DCC by the width of the material being installed. Then determine approximately how much you expect the flooring to change moisture content (MC) from one season to the next, and multiply this change in MC by the product of the width and DCC. This will give you an approximation of how much each plank of flooring could shrink/swell from season to season. Use this information to determine approximate internal expansion spacing necessary for the long-term performance of the wood floor.
 - c. Example: Red Oak DCC = .00369.
A 5" solid red oak plank that experiences a 4% change in moisture content, may shrink or swell tangentially approximately .0738".
 $.00369 \times 5" = .01845 \times 4\% \text{ change} = .0738"$ of change in dimension.
 - 3. Where additional internal spacing is required with some solid wood floors, use washers, edge trimmer spline, or other removable spacers to leave expansion space within the flooring system. The end-user must be made aware of these built-in spaces prior to installing them into the floor.
- F. Racking
- 1. With solid or engineered wood flooring installed over concrete or a wood panel subfloor and joist systems that meets or exceeds minimum requirements, properly staggered end-joints are an appearance/aesthetic consideration only.
 - 2. When racking (or laying out the floor) prior to installation, be sure to work from multiple bundles or packages to ensure color and length variation.
 - 3. Flooring warranties do not typically cover materials with visible defects once they are installed. Installation is considered acceptance of the product aesthetic quality.
 - 4. Distribute lengths randomly and pull from multiple bundles.
 - 5. Avoid "H" patterns when possible.
 - 6. Avoid any discernible pattern in adjacent runs such as blatant stair-steps or equal end-joint offsets in sequential rows. Cutting a variety of starter boards from full length boards will assist in "randomizing" joints in products of equal or limited lengths.
 - 7. End joints of adjacent boards should not be installed in close proximity to each other. In general, End-joint staggering, row-to-row should be a minimum of twice the width of the flooring being installed (e.g., 6" stagger for 3" wide material). Wider width materials may be more difficult to maintain these staggers due to the product length limitations.
- G. Precut and lay out a starter row along the entire length of the working line.
 - H. An anchor row is sometimes beneficial to the installation.
 - 1. An anchor row is one that may be set and secured to the substrate to provide a stationary point to be pushed against so flooring doesn't move during installation of the remaining floor.
 - 2. Creating an anchor row may include setting a section of flooring in the flooring adhesive the day prior to beginning the install or by setting a temporary starter row using a fastening mechanism, pressure sensitive tape, or temporary adhesive to create a backer for the flooring to be pulled against.
 - I. Many wood flooring adhesives are designed to be used in a wet-lay installation method, where you are able to spread the adhesive and begin to install the flooring immediately. Some adhesives may require flash-time prior to laying the flooring into the adhesive. Read the adhesive instructions prior to installation of any wood flooring.
 - J. Spread the adhesive with the appropriate trowel. Only apply as much adhesive as can be installed within the adhesive open-time period (see manufacture's recommendations for open-time based on adhesive type). Avoid excessive adhesive thickness and inconsistent application by passing the trowel evenly through the adhesive as recommended by the manufacturer.
 - K. Lay the flooring into the adhesive, in accordance with the wood flooring and adhesive manufacturer's instructions. Follow the flooring manufacturer's instruction for tongue and groove (T&G) direction and placement.
 - L. Correctly position the flooring and press down firmly.
 - M. Tapping blocks, pull-bars, and straps may be used to drive flooring tight during installation. Be certain to only use tapping blocks, pull-bars, or straps that do not damage the flooring.
 - N. Runs of flooring should generally be installed straight. Unless otherwise required, the installed wood flooring should not deviate from a straight line more than 3/16" in 10'.
 - O. Periodically lift boards immediately after installation and at regular intervals to ensure proper slab coverage and adhesive transfer to the back of the flooring from subfloor is achieved.
 - P. Spline/slip-tongue: Spline or slip-tongue is used to maintain T&G within the entire flooring system. Use spline/slip-tongue to fit the specific flooring profile.
 - 1. Use spline anytime the flooring direction changes, at all headers or flush transitions, and when reversing installation direction such as starting in the center of a layout or back-filling.

- 2. To install a spline/slip-tongue:
 - a. Cut to length.
 - b. Apply PVA glue or aliphatic resin (carpenters glue) to the bottom side of the receiving groove.
 - c. Insert the slip-tongue.
- Q. Use quick-release tape, straps, or tensioners to maintain a tight floor when necessary, and as suggested by the adhesive manufacturer.
- R. Nail-assisted glue-down:
 - 1. With full-spread installations over wood subfloors or sleepers/screeds, it may be necessary or helpful to blind-nail the flooring into the wood subfloor periodically.
 - 2. This method may be appropriate where flooring needs to be driven tight during the installation.
 - a. There is no recommended nailing schedule for this method, as the fasteners are strictly used as a supplement to the glue-down method.
- S. If recommended by the adhesive manufacturer, roll the floor with the proper weight roller.
- T. Clean all adhesive residue from the flooring surface using a proper adhesive remover as recommended by the adhesive and flooring manufacturer. Use the recommended cleaner to remove any residue that may have been left from the proper adhesive remover. Do not use a product or process that could damage the finished flooring.
- U. Allow the floor to set for at least 24 hours, or as otherwise directed by the adhesive manufacturer, before allowing foot traffic.
- V. Be sure the adhesive has had adequate time to dry and finish off-gassing before any topcoats of finish get applied to the floor.

PART V End-Grain Installation

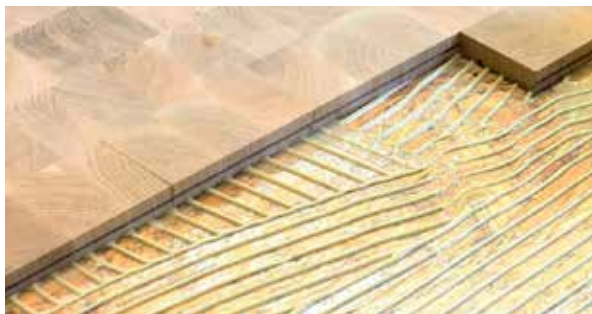

- A. Determine the layout before adhering end-grain blocks to the substrate.
- B. Begin the installation at a point opposite of the main entrance in order to minimize walking across a newly glued-down installation. Wall-

- layout option is the most appropriate for glue-down installations. Refer to the Layout chapter for more-detailed information.
- C. Undercut door casings and jambs. Remove any existing base, shoe mold, or doorway thresholds. These items can be replaced after installation.
- D. Snap a working line parallel to the starting wall, accounting for necessary expansion space.
- E. Expansion space:
 - 1. In facilities that do not have consistent climate controls in place, shrink/swell should be accounted for within the installation.
 - 2. End-grain flooring often requires expansion space to be added within the flooring system, based on the season of installation and the tangential shrink/swell value of the species being installed.
 - 3. Many end-grain installations are installed with a slight gap between each block to allow for normal swelling. Depending on the size of the end-grain blocks, it is not uncommon to have 1/8"-1/4" (3-5 mm) expansion built into the system throughout the installation.
 - 4. The typical rule of thumb for perimeter expansion is to maintain 3/4" space at all vertical obstructions.
- F. Racking: due to the varying wood grain patterns and other distinguishing characteristics that are prevalent in each individual end block, make sure to lay out the blocks in a random pattern.
- G. An anchor row is sometimes beneficial to the installation.
 - 1. This anchor row is one that may be set and secured to the subfloor to provide a stationary point to be pushed against so flooring doesn't move during installation of the remaining floor. Creating an anchor row may include setting a section of flooring in the flooring adhesive the day prior to beginning the install.
 - 2. Set a temporary starter row using a fastening mechanism, pressure-sensitive tape, or temporary adhesive to create a backer for the flooring to be pulled against.
- H. Many wood flooring adhesives are designed to be used in a wet-lay installation method, where you are able to spread the adhesive and begin to install the flooring immediately. Some adhesives may require flash-time prior to laying the flooring into the adhesive. Read the adhesive instructions prior to installation of any wood flooring.
- I. Spread the adhesive with the appropriate-size trowel. Only apply as much adhesive as can be installed within the adhesive open-time period (see manufactures recommendations for open-time based on adhesive type). Avoid excessive adhesive thickness and inconsistent application by passing the trowel evenly through the adhesive as recommended by the manufacturer.

- J. Lay the flooring into the adhesive, in accordance with the wood flooring and adhesive manufacturer's written instructions. Correctly position the flooring and press down firmly.
- K. During installation, use a white/non-marring flooring mallet on each end every block to ensure all are embedded properly into the adhesive. Tapping blocks and pull-bars also may be used to drive flooring tight during installation. Be certain to only use tapping blocks or pull-bars that do not damage the flooring.
- L. Periodically lift the blocks immediately during installation and at regular intervals to ensure proper slab coverage and adhesive transfer to the back of the flooring from subfloor is achieved.
- M. Use quick-release tape to maintain a tight floor when necessary, and as suggested by the adhesive manufacturer. Maintain adequate expansion on all four sides of each block when conditions are expected to fluctuate.
- N. If recommended by the adhesive manufacturer, roll the floor with the proper weight roller.
- O. Clean all adhesive residue from the flooring surface using a proper adhesive remover as recommended by the adhesive and flooring manufacturer. Be sure and use the recommended cleaner to remove any residue that may have been left from the proper adhesive remover. Do not use a product or process that could damage the finished flooring.
- P. Allow the floor to set for at least 24 hours, or as otherwise directed by the adhesive manufacturer, before allowing foot traffic.
- Q. Be sure the adhesive has had adequate time to dry and finish off-gassing before any topcoats of finish get applied to the floor.

PART VI Cork Flooring Glue-Down Installation



Similar to wood, cork is hygroscopic, meaning it is subject to the normal behavior of shrinking and swelling during periods of low and high humidity. In general, solid and engineered cork tiles and planks

may be installed below, on, or above grade in properly conditioned spaces.

- A. Check with the cork flooring manufacturer and the moisture meter manufacturer for the proper process of setting your meter to test the cork flooring. Check the cork flooring moisture content to ensure it is compatible with the jobsite conditions.
- B. For solid or engineered cork intended to be used as a finished floor covering, follow these instructions unless otherwise directed by the cork manufacturer:
 1. Determine the layout before adhering any cork flooring to the substrate.
 2. Installation of a smooth ¼" (or greater) underlayment-grade plywood is often required to be installed over the existing substrate for any glue-down cork installation. Fill cracks and sand uneven areas to create a smooth substrate for this resilient material. Any imperfections in the substrate surface will telegraph through the cork flooring.
 3. Mix cork tiles or planks from various cartons to maintain natural color and pattern variation.
 4. Due to the resilient nature of cork, solid cork products may often be "net-fit" to adjoining flooring and vertical obstructions. With engineered cork, follow the cork flooring manufacturer instructions for proper perimeter expansion, and installation method.
 5. Water-based contact adhesives are most-often recommended for glue-down installation of cork tiles or planks. Follow the flooring manufacturer's instructions on which adhesive to use, proper installation methods, necessary flash-time, and application methods.
 6. Use a subfloor primer as directed by the adhesive manufacturer.
 7. Always test for proper adhesion prior to proceeding with the installation.
 8. Continue the process with each tile or plank.
 9. Lay the cork in place, and then set it by rolling the entire tile or plank with a small hand-held j-roller, or hitting with a white/non-marring flooring mallet, or as otherwise indicated by the flooring manufacturer. Contact adhesives that require "setting" with a mallet are considered "set" with the impact of the mallet.
 10. If recommended by the adhesive manufacturer, roll the floor with the proper weight roller.
 11. Allow the floor to set for at least 24 hours, or as otherwise directed by the adhesive manufacturer, before allowing foot traffic.
 12. Be sure the adhesive has had adequate time to dry and finish off-gassing before any topcoats of finish get applied to the floor.

INSTALLATION METHODS: Floating

No matter the specific job requirements, there are several items that need to be addressed and followed during any floating-floor installation. When available, the flooring manufacturer's instructions should be followed. This includes all recommendations and requirements that give instruction on preparation, installation, or use of the wood floor. Where manufacturer instructions are unavailable, lack information, or they reference NWFA Guidelines, use the following information.

PART I

Type of Flooring

- A. With floating-floor installations, flooring panels are not attached to the substrate. Wood floors that can be floated either feature a tongue-and-groove construction, or edges with a locking mechanism.
- B. When installing a floating-floor, engineered flooring is the only type of wood floor that can be used.
- C. Solid wood flooring should never be installed using the floating-floor method unless otherwise recommended and warranted by the flooring manufacturer. In general, solid wood is not dimensionally stable enough, when exposed to seasonal changes, to withstand this installation method. Solid flooring includes solid strand woven flooring products.

PART II

Substrate Requirements

- A. Engineered wood flooring may be floated over most subfloors, as long as it meets the minimum requirements as detailed in the applicable chapter.
- B. Inspect the substrate to ensure it meets all requirements for the flooring being installed. This includes:
 1. Integrity of the subfloor: all substrates must be sound.

2. Flatness

- a. For floating-floor installation methods, all substrates should be flat to within minimum tolerance of 1/8" in 6', or 3/16" in 10', unless otherwise specified by the wood flooring manufacturer.
- b. Wood flooring should not be floated on ramps or non-flat surfaces.

3. Moisture test the subfloor in relation to the flooring being used. Refer to the Moisture Testing Wood chapter for testing information.

- a. When testing for moisture, both the wood flooring and the subfloor should be evaluated.
- b. **IMPORTANT:** Never install a wood floor or underlayment over a known moisture condition. A known moisture condition is one that you are aware of, and could pose future damage to the flooring, the building, or the occupants. It is compulsory practice to always test for moisture regardless of conditions so that any unknown conditions can become known conditions, which then can be handled appropriately.

4. A wood subfloor must meet all joist/floor truss spacing & panel thickness requirements as detailed in the Wood Subfloors chapter.

5. Over 23/32" plywood or OSB, floating-floors may be installed in any direction in the room, regardless of joist direction. This is because the floor acts as an independent, monolithic unit.

PART III Underlayments

There are many underlayment systems available for floating-floor installation methods when specifying the project. Refer to the Sound Control/Acoustical Underlayments chapter for more information.

- A. Acoustical underlayment materials may include cork, recycled rubber or cork/rubber blends, foam pads, recycled cellulose fiber materials, and dimpled or peel-and-stick membranes. These materials may be attached to the flooring itself, floated over the subfloor, or adhered to the subfloor. Follow the underlayment manufacturer's instructions for the proper application and installation of the underlayment.
- B. Underlayments can impact wood flooring performance. When installing a floating-floor, the underlayment material functions may provide sound control and/or moisture control. Check with the flooring manufacturer or Homeowner Association's Covenants, Conditions, and Restrictions (CC&Rs), for specific underlayment requirements. Refer to the Underlayments chapters for more information.
- C. Over concrete substrates, when the acoustical underlayment material does not include a vapor retarder, installation of a separate Class I vapor retarder underneath the acoustical underlayment will be necessary.
- D. Over wood substrates above unconditioned spaces, when the acoustical underlayment material does not include a vapor retarder, installation of a separate Class II vapor retarder underneath the acoustical underlayment may be necessary.
- E. Any underlayment materials used below a floated wood floor should have a published compression resistance that meets all minimum requirements of the flooring being installed over it. Check with the flooring manufacturer for minimum compression resistance requirements.
- F. Determine the IIC, Delta IIC, or STC requirements, then work with the builder, architect, and specifier to identify a flooring and underlayment combination that aligns with the facility requirements. Follow the flooring and underlayment manufacturer installation instructions and ensure the product used is a part of an entire sound control system.

- G. The acoustical underlayment should have a published Delta IIC rating. The Delta IIC rating provides the flooring products contribution to the entire assembly in terms of isolating impact footfall noise. The Delta IIC rating can be used to compare the performance of different underlayment materials.
- H. Pressure-sensitive peel-and-stick underlayments (engineered wood flooring only).
 - 1. One-sided peel-and-stick underlayments with the sticky-side faced down, used as an acoustical underlayment or moisture retarding membrane, must be installed per underlayment manufacturer instructions.
 - 2. One-sided peel-and-stick underlayments with the sticky-side faced up, are used as a method to mechanically adhere the flooring to the underlayment material, and must be installed per flooring and underlayment manufacturer instruction.

PART IV Expansion Space/ Transitions

- A. Maintain proper expansion space at all vertical obstructions to allow for expansion/contraction of the monolithic flooring unit, based on the material being installed. Unless otherwise directed by the flooring manufacturer, expansion space left between the flooring and vertical obstructions are generally equal to the thickness of the material being installed. (Example: 1/2" thick material requires 1/2" expansion space.)
- B. Transition pieces allowing for expansion space should be built into the floating-floor system at any doorways less than 4 feet in width, and within any flooring system that spans greater than 20 feet in width or greater than 40 feet in length (in comparison to flooring installation direction), unless otherwise directed by the flooring manufacturer.
- C. Baseboard, base shoe, quarter round, and other trim pieces must not come into contact with the wood floor, allowing it to remain floating. Trim pieces should be held off of the floor a minimum of 1/16", and should never be fastened to or through the flooring system.

- D. Overlapping floor transition pieces (such as T-moulding and baby thresholds) must allow the flooring system to remain floating. Proper installation of transition pieces involves anchoring them only to the substrate and not directly to the flooring, allowing the flooring to remain completely independent.
- E. Undercut all door casings 1/16" higher than the thickness of the flooring and underlayment material being installed. Place a scrap piece of plank and a sheet of underlayment against the door casing to act as a guide and cut the door casing with a hand saw or power jamb saw set to the correct height.
- F. Areas that cannot receive baseboard or shoe moulding such as abutting floor coverings, stone fireplaces, staircase stringers, electrical outlets, or other fixed elements in the home, must allow for adequate expansion as well. This can be achieved by undercutting appropriate abutting material, or by using overlapping transitions.
- G. Floating-floors should never be installed where future fixed cabinetry (such as kitchen islands) will lock the floor down, as these are considered "fixed vertical obstructions."
- H. Any heavy furniture or appliances such as pianos, pool tables, entertainment centers, or refrigerators can affect the ability of the floor to move as an independent monolithic unit, and may require additional expansion space built into the flooring system to accommodate. A point load on a single board of more than 600 lbs can keep the floor from floating. Check with the flooring manufacturer for specific point-load requirements, and advise the end-user of this condition prior to the product selection or installation.

PART V Floating-Floor Installation

- A. Remove all doors and shoe mouldings.
- B. Layout will determine the overall appearance of the floor. Plan the layout to avoid the final row being too narrow and for transition placement.
- C. After determining the direction to run the flooring, measure the width of the room (the dimension perpendicular to the direction of the flooring), and divide by the width of the flooring planks. The last row of the flooring should be no less than 2" wide (unless otherwise dictated by the flooring manufacturer), unless the entire job layout doesn't allow. Adjust the width of the starter row to avoid a narrow last row where possible.
- D. Install the manufacturer-recommended underlayment material as required by the underlayment and flooring manufacturers.
- E. Racking
 - 1. When racking (or laying out the floor) prior to installation, be sure to work from multiple bundles or packages to ensure variation. Distribute lengths randomly and pull from multiple bundles/packages.
 - 2. Flooring warranties do not typically cover materials with visible defects once they are installed. Installation is acceptance of product aesthetic quality.
 - 3. End joints of adjacent planks should not be installed in close proximity to each other. In general, end-joint staggering row-to-row should be a minimum of twice the width of the flooring planks being installed. For example, a 5" wide plank would require a 10" stagger row-to-row.
 - 4. Avoid "H" patterns when possible and avoid any discernible pattern in adjacent runs such as equal end-joint offsets on sequential rows and blatant stair-steps, unless otherwise directed by the flooring manufacturer.
 - 5. With some flooring materials, the installer is unable to follow the traditional racking guidelines due to available product lengths. Cutting a variety of starter planks from full length planks will assist in "randomizing" joints in products of equal or limited lengths.



F. Edge-glued floating-floors

1. Apply the specified glue as recommended by the flooring manufacturer. Amount, placement, and type of glue will vary from one wood flooring product to another. Poly vinyl acetate (PVA) glue generally is recommended for floating-floor installations.
2. Glue takes time to dry and will require additional time before foot traffic is allowed. Strapping the boards will help to avoid the installed flooring coming out of alignment before the glue completely dries.
3. Engage the tongue and groove snugly. Use of tapping blocks, straps, or a scrap piece of flooring may be necessary to get the flooring tight. Do not damage the edge, butt-end, tongue, or the groove while tapping the product into place.
4. At the end wall, use an end pry bar, if needed, to pull the ends of the planks tight.
5. Clean any excess glue from the surface of the planks as necessary.



G. Locking mechanism floating-floors

1. There are three basic types of locking systems referred to by how the boards are attached to each other, along the length of the plank/and at the ends of the plank:
 - a. **Angle/angle-locking systems:** The plank must be angled upward to engage the locking mechanism along the length of the plank as well as the ends of the plank before lowering it to complete the connection. This must happen at the ends first (normally along the entire row), then along the length of the planks.
 - b. **Angle/hook-locking systems:** The plank must be angled upward to engage the locking mechanism along the length of the plank, but the ends of each plank have a hook lock connection. The ends are not locked in until the next row has been installed.
 - c. **Angle/fold down-locking systems:** Also called "single-action locking" as it locks the floor in one single motion often with an audible click sound. The plank must be angled upward to engage the locking mechanism along the length of the plank, but the ends are equipped with a mechanical locking function that actually locks the ends in place.
2. Ensure you lock the lengths and the ends of the flooring together correctly as per manufacturer recommendation of the particular locking mechanism being used.

H. Peel-and-stick installations

1. Follow the floating-floor installation instructions for any engineered wood floor being placed over these underlayment materials.
 2. With the underlayment material rolled out, peel and fold back the protective film no more than the width of each plank being installed, exposing the adhesive layer of the pad. Carefully lay each plank tightly into place, and then apply pressure to set it.
- I. As with all hardwood flooring, the first row alignment is critical. Misaligned starter rows

can cause side and end gaps to appear in proceeding rows of flooring. Complete the first row. Make sure there are no gaps between the planks. Runs of flooring generally should be installed straight, measuring no more than 3/16" out of straight in a 10' run.

- J. Start each subsequent row with the cut-off end of the last board from the previous row whenever possible. Such cut off piece should be no less than 12" in length.
- K. Continue to install the floor repeating the process until the completion of the floor.

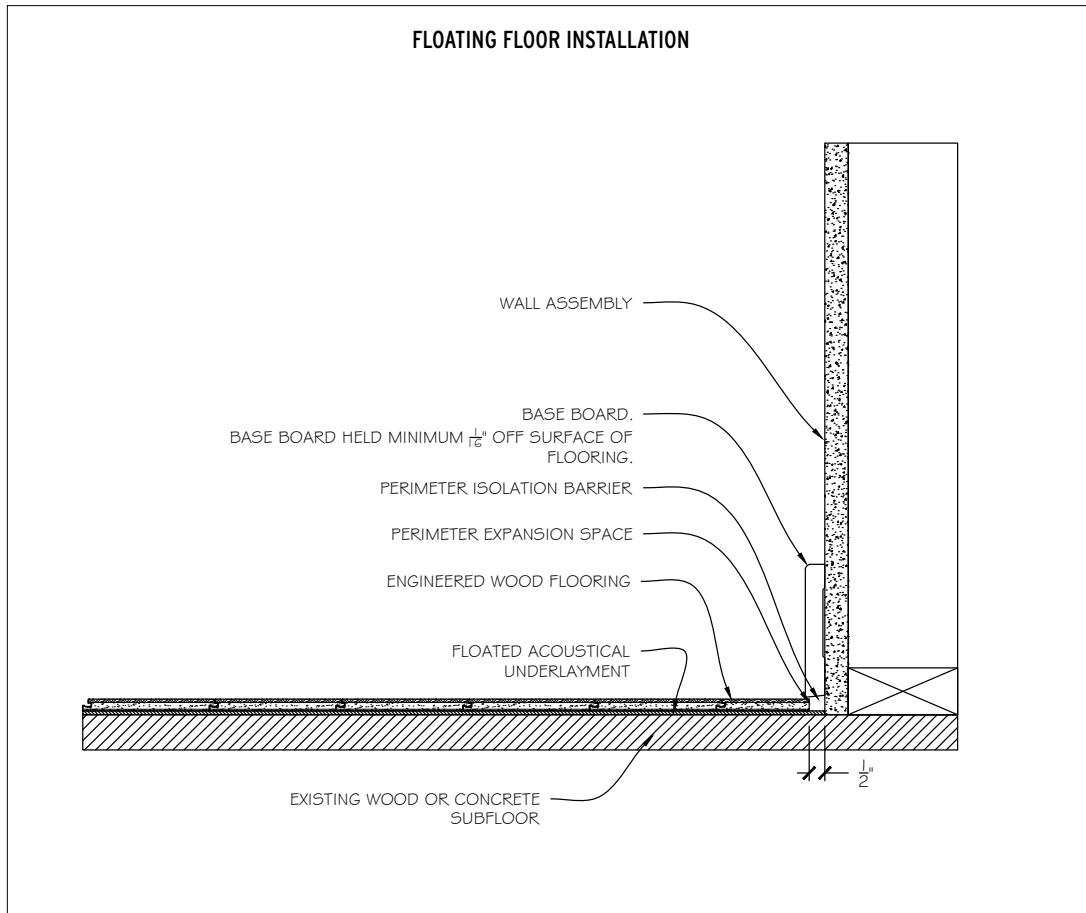

INSTALLATION METHODS: Parquet

Parquet wood floors are a specific type of wood floor that has a geometric pattern.

PART I Parquet Patterns

- A. Parquet patterns often take their names from famous people or places. The Monticello pattern, for example, is based on floors in Thomas Jefferson's home, and the Jeffersonian is a variation on that pattern. Others, such as Brittany, Bordeaux, and Canterbury, are named for places where they are thought to have originated.
- B. There are also geometric patterns like herringbone, chevron, rhombus, and standard block- pattern parquet. Custom parquet patterns can also be created.
- C. Parquet material thickness varies from 5/16" to 3/4" and may be solid or engineered. Parquet typically is made up of individual pieces, assembled into panels held together by wire, mesh, tape, or paperface (on the surface). Check with the manufacturer for specific installation instructions.
- D. When ordering parquet, base your measurements on the actual dimension of the pattern. The quantity of parquet tiles, blocks, or pieces necessary will be dictated by the jobsite layout, and the repetition of the pattern itself.

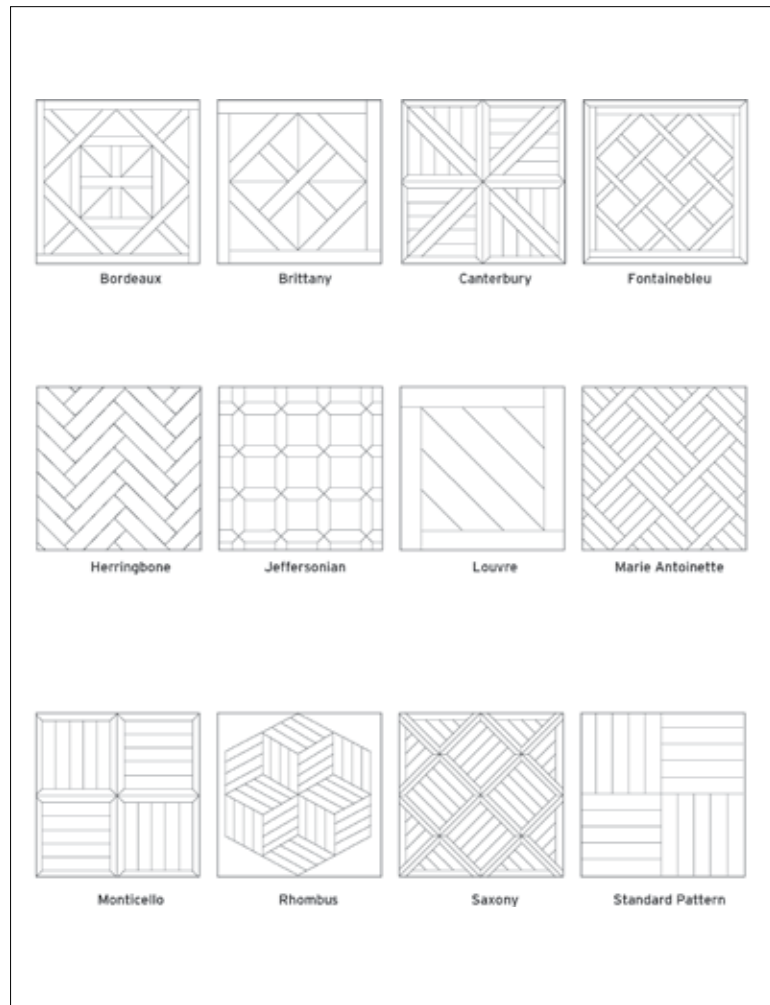

PART II Substrate Requirements

Parquet wood flooring may be installed over many substrates, as long as they meet the minimum requirements as detailed in the applicable chapter. Inspect the substrate to ensure it meets all requirements for the flooring being installed, and the method in which it is being installed.

- A. Wood subfloors (refer to the Wood Subfloors chapter for more detailed information).
 1. Inspect the wood subfloor to ensure it meets all flooring and adhesive manufacturer requirements.
 2. Test the wood subfloor material for compatibility with any wood flooring adhesive being used. (Some types of wood flooring adhesives do not adhere to some high-performance OSB panels.)
 3. Check that the type and integrity of the wood subfloor is appropriate for the wood floor installation. This includes subfloor thickness and joist/floor truss spacing requirements, maximum vertical deflection requirements, and that it is sound and free from squeaks and noises. Due to the varying grain orientation and pattern direction of parquet flooring, the joist/floor truss direction is not relevant to the installed parquet pattern direction.

4. Flatness: The standard for flatness with parquet installation methods on a wood subfloor is 3/16" in 10', or 1/8" in 6'.
 5. When testing for moisture, both the wood flooring and the wood subfloor should be evaluated and documented (refer to the Moisture Testing Wood chapter for testing information).
- B. Concrete subfloors (refer to the Concrete Subfloors chapter for more-detailed information)
1. Inspect the concrete subfloor to ensure it meets all adhesive and flooring manufacturer requirements.
 2. If any subfloor toppings such as self-levelers, skim-coatings, patches, trowelable underlayments, or floor-fills exist, ensure any sealers or adhesive products are compatible with these toppings.
 3. Flatness: The standard for flatness for a concrete subfloor with parquet glue-down installation methods is 3/16" in 10', or 1/8" in 6'.
 4. Moisture test the concrete subfloor in relation to the flooring being used. Refer to the Moisture Testing chapter for more information. When testing for moisture, both the wood flooring and the concrete subfloor should be evaluated.
- C. Solid board subfloors (refer to the Wood Subfloors chapter for more detailed information)
1. When gluing down parquet over solid board subfloors, installation of minimum 19/32 subfloor panels is required as an overlay to achieve a suitable substrate.
- D. Screeds/sleepers (refer to the Screeds/Sleepers chapter for more detailed information)
1. Full-spread glue-down and nail-assisted glue-down installation methods are appropriate over properly prepared screeds/sleepers embedded in concrete, or when screeds/sleepers have been overlaid with the appropriate wood panel subfloor.
- E. Radiant heat (refer to the Radiant Heat chapter for more detailed information)
1. When gluing parquet over any radiant heating system, refer to the Radiant Heat chapter for more information.
 2. Confirm the adhesive system being used is compatible with the radiant heating system.
 3. Reduce or turn off heat during installation of the flooring to avoid loss of open/working time, premature drying, and skinning-over of the adhesive. Check with the adhesive manufacturer for minimum/maximum subfloor temperature limitations during the installation.

PART III Parquet Layout

- A. In general, when a wood floor is laid out in a repetitive pattern, such as with parquet, the pattern should be balanced within the space. When the parquet pattern is installed wall-to-wall in a room that is not symmetrical, or when the pattern flows from one room to another, the floor pattern may not be balanced in all rooms.
- B. With any parquet patterned floor, use the center-layout method to transfer and adjust your starting lines according to the most aesthetically or architecturally important elements in the rooms, taking into consideration doorways, fireplaces, cabinets, and transitions, as well as the dimensions of the pattern and the overall squareness of each room. (Refer to the Layout chapter for more-detailed information.)
- C. In order to properly layout the parquet pattern within the given space, the dimensions of the pattern should be taken into account.
- D. The layout includes finding the center of the pattern to help identify the best balance within the space. Base your working line measurements on these dimensions and the room characteristics where the flooring will be installed. Transfer lines as necessary to where the flooring installation will begin.
- E. Use the dimensions of the parquet pattern to snap chalk lines across the subfloor indicating where each run will lie. This will allow you to know where to apply adhesive during the installation as well as to maintain straight lines during install.
- F. Verify all measurements before proceeding with installation and application of adhesive.

PART IV Parquet Tile Installation

- A. Expansion space should be a minimum of 1/2" around the perimeter and all vertical obstructions, unless otherwise directed by the flooring manufacturer.
- B. Parquet is often glued, but can also be blind-nailed (in a nail-assisted glue-down method) as long as the pattern continues to have an exposed side tongue for nailing.
 1. Nail-assisted glue-down:
 - a. With full-spread installations over wood subfloors, it is sometimes necessary or helpful to blind-nail the flooring into the wood substrate periodically.

- b. This method may be appropriate where flooring needs to be driven tight during the installation. There is no recommended nailing schedule for this method, as the fasteners are used strictly as a supplement to the glue-down method.
 - c. Be extremely cautious of the impact from the pneumatic nailer on the parquet tiles. The impact can force the parquet tiles out of their intended placement, knocking the pattern out of square.
- C. After both chalk lines (at 90 degrees to each other) have been snapped, start spreading the adhesive in the first laying area. Be careful not to spread adhesive beyond the chalk line or beyond your manageable work space.
- D. Immediately lay the parquet tiles in the newly spread adhesive, unless the adhesive requires flash time (check with the adhesive manufacturer).
1. Do not lay the floor tiles on dry or skinned-over adhesive. If the adhesive becomes dry, scrape it up and spread more.
 2. It is important to remember to stand or kneel on the subfloor during the installation to avoid shifting the installed parquet tiles.
- E. Proper placement of the first parquet tiles is the key to the entire installation.
1. Carefully place the first tile squarely into position at the point where the center lines cross. It is very important to lay the first few tiles perfectly on the chalk lines as this step will affect the entire installation. Do not use the edge of the tongue for aligning the tile on the chalk lines.



2. Place tiles firmly against the adjoining tiles and press into adhesive. Gently lock in the tongue and groove between the floor tiles when applicable.
3. Do not push, hammer, or force the tiles too strenuously as this could cause the tiles to move and misalign the squareness of the layout. Where you are able, set backer rails

along the chalk lines, providing a firm framework to apply force when engaging panels while not forcing the pattern out of square.

- F. After you have positioned several tiles along the working lines, begin stair-stepping the tiles into a progressive diagonal (or multilateral) pattern where two sides are always engaging two laid panels, progressing from the center outward until wall lines are reached. This ensures both a balanced install and the “squareness” of the installation.

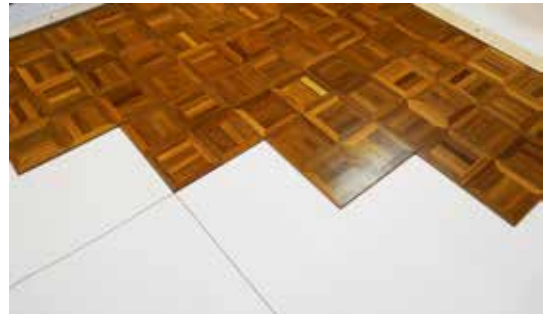

- G. Tapping blocks and pull-bars may be used to drive tiles tight during installation. Be certain to only use tapping blocks or pull-bars that do not damage the flooring.
- H. Periodically lift tiles immediately after installation and at regular intervals to ensure proper coverage and adhesive transfer to the back of the tiles from subfloor is achieved.
- I. Spline/slip-tongue: Spline or slip-tongue is used to maintain T&G within the entire flooring system. Use spline/slip-tongue to adjoin tiles when applicable.
- J. Use quick-release tape, straps, or tensioners to maintain a tight floor when necessary, and as suggested by the adhesive manufacturer.
- K. If recommended by the adhesive manufacturer, roll the floor with the proper weighted roller.
- L. Clean all adhesive residue from the flooring surface using a proper adhesive remover as recommended by the adhesive and flooring manufacturer. Be sure to use the recommended cleaner to remove any residue that may have been left from the proper adhesive remover. Do not use a product or process that could damage the finished flooring.
- M. Allow the floor to set for at least 24 hours, or as otherwise directed by the adhesive manufacturer, before allowing foot traffic.
- N. Be sure the adhesive has had adequate time to dry and finish off-gassing before any topcoats of finish get applied to the floor.

PART V Herringbone/ Chevron Installation

- A. **Glue-down installation:** Herringbone/chevron patterns are often glued down. Refer to the Glue-Down chapter for glue down information.
- B. **Nail-down installation:** Nail herringbone or chevron patterns using the appropriate nailing schedule for the flooring being installed as long as the pattern continues to have an exposed side tongue for nailing. Refer to the Nail-Down Installation chapter for nailing schedule information, and glue-assisted installation methods. (Be extremely cautious of the impact from the pneumatic nailer on the herringbone/chevron planks. The impact can force the planks out of their intended placement, knocking the pattern out of square.)
- C. **Nail-assisted glue-down:**



- 1. With full-spread installations over wood subfloors, it is sometimes necessary or helpful to blind-nail the flooring into the wood substrate periodically.
 - 2. This method may be appropriate where flooring needs to be driven tight during the installation. There is no recommended nailing schedule for this method, as the fasteners are strictly used as a supplement to the glue-down method.
- D. Herringbone direction should be installed in accordance with client preference. The distinct directional pattern may look best with the points in the direction of the longest dimension of the room, or toward a major focal point.
 - E. Herringbone-patterned floors can be ordered with 'left' and 'right' pieces because the pattern is directional. When looking at the face of the boards, they are a mirror image of each other. A universal form has grooves on both ends and slip-tongue or spline is used at each end connection.

- F. When laying out the floor prior to installation, be sure to work from multiple bundles or packages to ensure variation.
- G. Laying out a herringbone pattern:



- 1. Using the center-layout method, measure the room for center and strike the main control, perpendicular, and diagonal reference lines, as detailed in the Layout chapter.
- 2. Find true center on the pattern to establish the working lines.



- a. To find center of a herringbone pattern:
 - i. Divide the diagonal measurement by four. This is the dimension used to establish the working lines A and B on both sides of the control line.

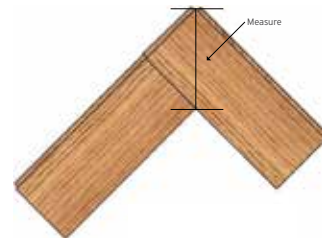

- ii. This measurement will vary according to the width of the flooring.
- b. To find center of a chevron pattern, measure the entire pattern width and divide by 2. The mitered point is center.

3. Strike two working lines alongside the main control line. Working lines for herringbone should fall through the corners of each alternating slat. Working lines for chevron patterns should fall on the opposite mitered end of each picket.
4. Transfer the diagonal lines to the working lines.
5. Dry-lay a small section and measure to confirm a balanced layout.
6. The floor pattern is installed along working lines.
7. Once the working lines are established, the installation can begin.
8. To keep the installation square, cut a square piece of plywood the size of the herringbone pattern and anchor it at the intersection of the working lines and diagonal lines.

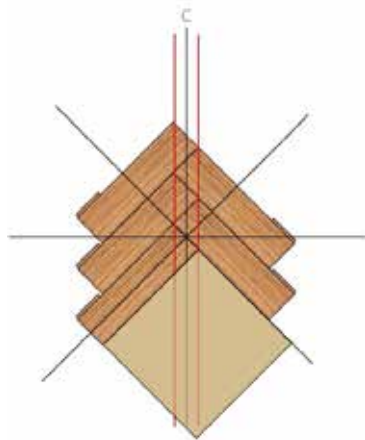

H. Installing a herringbone pattern:

1. The starting point must have working lines and diagonal lines.
2. For direct glue, do not spread adhesive over working lines.
3. Start with the tongue facing toward the build direction.
4. Install pattern one row at a time.
5. Periodically check alignment and squareness using a carpenter's square at the head of the run as it progresses.

- I. To continue the pattern:
 1. Dry lay approximately eight boards
 2. Lay a framing square from the points on the working line to the outermost point.
 3. Record measurement A; this becomes your working line for the next course.

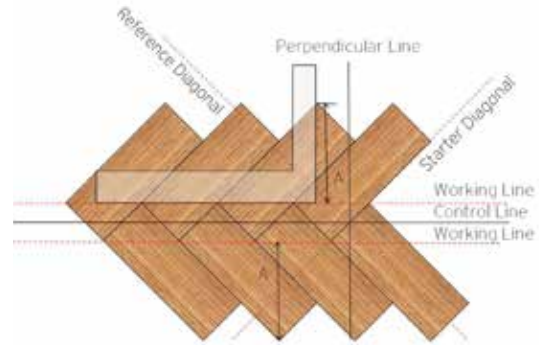

4. Once measurement A is established, the working lines can be repeated throughout the installation.

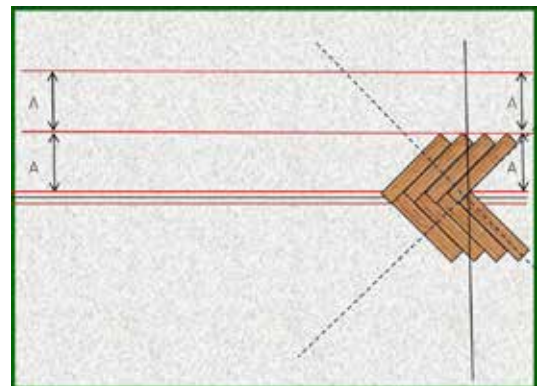

PROTECTION, CARE AND MAINTENANCE

PART I

Educating the Customer

Unlike most other floor coverings, wood floors are a long-term investment that, when properly maintained, will last for the lifetime of the structure in which they are installed. Creating realistic expectations and educating the customer on wood floor maintenance up front, before the flooring project begins, is critical to the long-term performance of the wood floor.

Educating the customer includes:

- A. Explanation of proper maintenance, both preventative and routine.
 - 1. Preventative maintenance includes use of items such as floor protectors and throw rugs.
 - 2. Routine maintenance includes use of the proper cleaning products, and regular maintenance coats.
- B. Provide the customer with information about which cleaning product they should use on their wood floors. The end-user should be made aware that improper cleaning products can damage floor coatings, can cause adhesion problems with future maintenance coats, and may void manufacturer and labor warranties.
- C. Explain how temperature and relative humidity affect wood floor performance. The end-user should be made aware that temperature and relative humidity are often a part of the warranty of their flooring.

PART II

Protection

A. Post-installation

- 1. After installation, if you choose to protectively cover the floor, cover the floor completely. Some species are light-sensitive and uncovered areas may change color.
- 2. Covering a glue-down application may not allow some adhesives to properly cure. Follow the flooring and adhesive manufacturers' recommendations.
- 3. Use a covering material with a vapor permeance (perm rating) of no less than 1 perm (class III vapor retarder).

- 4. Any covering should be taped, using a low-adhesion tape, to base or shoe mouldings. Do not tape to finished flooring. When taping paper or sheets together, tape them to each other, not to the floor.
 - 5. Do not allow the floor covering to sit on the installed floor for an extended period of time.
- B. Rugs
- 1. Use breathable throw rugs both inside and outside the doorways to help prevent grit, salt, chemicals, sand, moisture, and other debris from being tracked onto wood floors. Do not use non-breathable floor coverings or floor protectors on wood floors.
 - 2. Rugs should regularly be shaken out, cleaned, and thoroughly dried, before being placed onto a wood floor.
 - 3. Unless otherwise defined by the finish manufacturer, area rugs should not be placed on a newly finished wood floor for a minimum of seven days after the final coat of finish has been applied.
 - 4. Take special precautions with special nonskid pads that are frequently placed under area rugs. Some of these pads may imprint their pattern (surface impressions) onto the finish and/or wood floor. (Natural fiber pads may not transfer as much as some synthetic pads.)
 - 5. Be aware that area rugs cover the wood floor, protecting it from UV/sun exposure, which results in color differences in the wood floor.
- C. General protection
- 1. Put fabric-faced glides under the legs of furniture to prevent scuffing and scratching. Periodically check these floor protectors for embedded soil and replace as necessary.
 - 2. Avoid walking on wood floors with cleats, sports shoes, and high heels.
 - 3. Keep pet claws trimmed and in good repair.
 - 4. Do not slide heavy furniture across wood flooring. It is best to pick up the furniture completely and place it where it needs to be.
 - 5. When moving appliances (refrigerators, stoves, etc.), use safety glides. On newly finished floors, wait a minimum of three days before replacing appliances.

PART III

Care and Cleaning

- A. Establish a cleaning regimen and incorporate floor cleaning into the facility's cleaning routine.
 - 1. Dry sweep wood floors frequently (daily) to remove fine and large particles from the floor's surface. Use a high-quality dry dusting mop with disposable or washable cloths that removes the dirt from the surface. Particles have the potential to be ground into floors potentially causing damage to a floor's finish. Fine dirt particles when introduced to moisture can turn into a film that dulls the look of the wood floor.
 - 2. Only use vacuum cleaners that have a setting for hard-surfaces. Turn off the carpet setting (beater/bar brush) on vacuum cleaners when present.
 - 3. If spills occur, wipe them up immediately to prevent damage caused by standing liquid.
 - 4. Damp mop floors regularly (weekly) to keep wood floors looking their best.
 - a. The mop should be slightly moistened and well-wrung out, ensuring the amount of moisture left on the floor surface is minimal.
 - b. When using spray mops, use only high-quality spray mops that provide greater control over the amount of solution that is applied, and that come with super-absorbent, disposable or washable pads that remove the cleaning solution and soil from the floor's surface.
- B. Consult the flooring or finish manufacturer's recommendations for general maintenance practices and which cleaning products to use.
- C. Wood floor finishes such as natural oils or waxes require extra precautions. Follow the additional instructions as provided by the flooring and/or finish manufacturers.
- D. When the flooring or finish manufacturer is unknown, a wood flooring professional should be able to identify the type of finish on the floor and recommend an appropriate wood floor cleaning product.
- E. It is important to maintain a consistent environment throughout the year to minimize floor movement. Use of a humidifier throughout the winter/dry months and/or dehumidifier in the summer/humid months to help keep wood from gaining or losing moisture.
- F. When the floor loses its luster, it's time for a maintenance coat.

PART IV

Maintenance

- A. Factory-finished wood floors
 - 1. Using a non-recommended cleaning product to clean the floor may ruin the intended appearance of the finish, and it may also cause finish adhesion problems when it is time for the floor to be recoated. Excessive use of any wood floor cleaners can damage the wood floor. Only use cleaners as recommended by the flooring manufacturer.
- B. Site-finished wood floors
 - 1. Using a non-recommended cleaning product to clean the floor may ruin the intended appearance of the finish, and it may also cause finish adhesion problems when it is time for the floor to be recoated. Excessive use of any wood floor cleaners can damage the wood floor. Only use cleaners as recommended by the finish manufacturer.
- C. Oiled floors
 - 1. Many natural oil finish manufacturers recommend a specific maintenance routine of using oils and soaps on a regular basis. Failure to follow specific maintenance procedures will result in a finish that will not last as intended.
 - 2. The oil finish may periodically need to be reapplied. There are many different types of oil finishes and each has a specific maintenance program.
 - 3. On oiled floors, never use traditional wood floor cleaners, as they can damage the oil finish.
- D. Waxed floors
 - 1. Rebuffing existing wax finish can revitalize most dull waxed floors. Application of new wax may be necessary periodically. Avoid wax buildup under furniture and other light traffic areas by applying wax in these spots every other waxing session.
 - 2. On waxed floors, never use water-based cleaners, as they can cause water spots.
- E. Non-urethane coated acrylic impregnated floors
 - 1. For white/bleached acrylic enhanced products, always use an untreated mop. Never use water or petroleum-based products. The floor should be buffed with a low-speed buffer and a recommended product specifically for white/bleached floors. More maintenance will be required for white/bleached floors.
 - 2. Some flooring manufacturers recommend that floors that have become dull can be lightly abraded, and then a recommended conditioning product should be used.

3. Follow the manufacturer's directions for spot-cleaning stubborn stains. Methods may include spot-sanding or lightly abrading, and then applying the recommended cleaner and conditioner, or using mineral spirits or hydrogen peroxide and a hand-sized piece of synthetic pad to remove the stain.
 4. Note that recoating these types of floors with a urethane will typically void any manufacturer's warranty.
- F. Sports floors
1. Sports floors from basketball to aerobics studios usually take a beating from heavy daily use. Specific recommendations for sports floors are available from the Maple Flooring Manufacturers Association (MFMA): www.maplefloor.org.
 2. General MFMA maintenance guidelines include the following:
 - a. Dry mop the floor daily with a properly treated dust mop. Floors with especially heavy use should be swept up to three times per day.
 - b. Use walk-off mats at all doorways.
 - c. Wipe up spills or any other moisture on the floor immediately.
 - d. Remove heel marks/scuffs using a floor finish manufacturer's approved wood floor cleaner applied with a soft cloth or dust mop.
 - e. Do not use household cleaning products or products designed for other flooring surfaces, which may damage the floor finish and also may leave the floor sticky or slippery.
 - f. Do not clean the floor with scrubbing machinery or power scrubbers, unless the flooring and finish manufacturer recommends doing so.
 - g. Ensure the HVAC system is working properly, with normal humidity levels and temperatures. Indoor relative humidity should be maintained between 30-50% and a temperature between 60-80°F year-round.
 - h. Do not shut down the HVAC system for prolonged periods of time.
 - i. Inspect the floor for abnormal shrinkage and swelling. During the summer months/humid seasons, carefully monitor all exterior doors and windows for leaks.
 - j. Remove debris from expansion voids within the flooring system.

PART V

What Not to Use

- A. Do not use sheet vinyl or tile floor care products on wood floors.
- B. Do not use self-polishing acrylic waxes, which add a film to the floor surface. These products can cause flooring to become slippery, scuff, and appear dull quickly, unless otherwise recommended by the finish or flooring manufacturer.
- C. Do not use cleaning products that claim to restore, rejuvenate, add-shine, polish, or renovate the wood floor, unless otherwise recommended by the finish or flooring manufacturer.
- D. Do not use household wet dusting products to clean wood flooring, unless otherwise recommended by the finish or flooring manufacturer.
- E. Never use wax on non-waxed surface finishes.
- F. Do not use petroleum-based cleaners on waterborne finishes.
- G. Do not use wood floor cleaning products designed for film finishes on natural oiled finishes.
- H. Do not use oil soaps on urethane or film-forming finishes, unless otherwise recommended by the finish or flooring manufacturer.
- I. Do not use vinegar on wood floor finishes. Vinegar is acidic and will degrade the floor finish.
- J. Do not use a traditional mop and bucket that has a potential to apply too much moisture to the wood floor. Standing water will result in cracks, splits, cupping, warping, degradation of the finish, and can leave a discoloring and sometimes sticky residue.
- K. Do not use steam-cleaners on wood floors. Water in a vapor form will penetrate the wood fibers and cause irreversible damage to the wood flooring and the finish.

REPAIR, REPLACEMENT AND REMOVAL

When a wood floor becomes damaged, or is in need of repair, it is important to evaluate the damage to make an informed determination of the most appropriate action. It is recommended that all wood flooring damage be evaluated by an NWFACP Certified Professional, NWFA Member, or equivalent, to ensure appropriate action is being considered.

PART I Repair

Damages can usually be grouped into one of several categories:



- A. Scratches may require isolation repairs, recoating, or resanding of the affected areas.
 - 1. Surface scratches are typically only in the finish coats. A fingernail can't feel the ridge.
 - 2. Deep scratches are typically through the finish coats and have torn the wood fibers.
 - 3. Cross-grain scratches are deep scratches, and are oriented perpendicular to the direction of the flooring, often crossing multiple board widths.
- B. Dents/gouges may require isolation repairs, resanding, or replacement of affected areas.
- C. Indentations are notches or depressions on the surface of the flooring. Indentations are caused by the excessive force of an object on the flooring surface. Surface finishes minimally influence the effects of these forces. Janka hardness ratings give us an idea of approximately how each species can be affected by such forces. Objects that can cause indentations can include, but are not limited to:

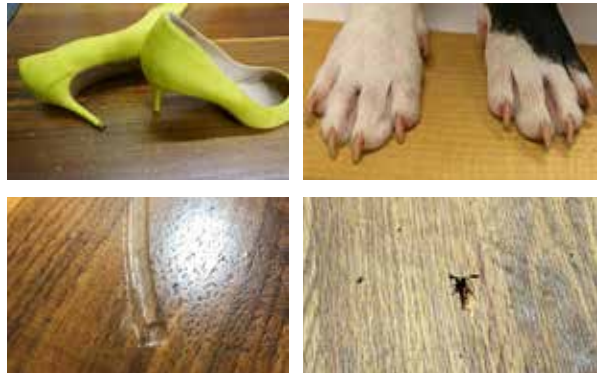

- 1. High heels
- 2. Dog claws
- 3. Appliances and furniture
- 4. Heavy grain tear or chunks of wood torn away or removed

- D. Stains can include permanent damage from pet urine, chemical/moisture spills, or may just be residues or minor characteristics of the wood itself. Oftentimes stains require resanding and/or replacement of the affected areas.



- E. Water damage can vary in severity, from minor cupping to severe buckling. Each case must be dealt with on an individual basis for repair options. The most important aspect of repairing water-damaged



flooring is having a thorough understanding of the moisture content of the flooring, substrate and ambient conditions in the space surrounding the flooring system prior to assessing repair options. (Refer to Part V, Addressing Water Damage, for more detail.)

- F. For nail-down or glue-down installations exhibiting minor deflection, hollow spots, or slight popping noises, using injection adhesives at the location that needs to be addressed is an appropriate and sometimes necessary repair. This can be accomplished by pre-drilling a hole in the board at the designated site, with a bit that coincides with the diameter of the syringe being used. Insert the syringe into the hole and inject the adhesive. A dowel rod or toothpick may then be inserted into the hole and cut flush with the flooring surface, to act as an anchor as the adhesive is drying.
- G. Isolation repairs of damaged areas may include using fillers, putties, or colored markers to make the blemish disappear. Many times, use of these repair tools and products involves filling the damaged area to the flooring surface level, adding color to the area and replacing natural wood characteristics by use of graining tools. Once the area has been reasonably matched to the surrounding surfaces, sheen level and film build are the final steps.



PART II Replacement

When an individual board cannot be touched-up or repaired, it may need to be replaced. Board replacement may include an individual board or a grouping of boards. Whether the board replacement is happening on a nailed floor, a glued floor, or a floated floor, the process is very similar.

A. Removal of damaged nail-down and glue-down flooring (solid or engineered):

NOTE: Always wear safety glasses and hearing protection.

1. Individual boards can be repaired or replaced without affecting adjoining boards.
2. Make sure you have a replacement board selected and prepared before beginning the repair.
3. Check the species (red oak, white oak, etc.), grade, cut of wood, width, thickness, bevel

profiles, sheen level, and color match, to ensure a proper match.

4. The moisture content of replacement boards should be no more than 2 percent difference between the new flooring and the existing flooring. If the difference is greater, allow the new flooring to acclimate until it is within 2 percent of the existing flooring.
5. Replacement boards do not have to be from the original manufacturer, as long as the tongue and groove profile, width, bevel, edge profile, cut of wood, and grade all match.
6. If the board to be replaced is more than four feet long, consider doing the repair in two sections to minimize the risk of the opening closing-up width-wise while you are completing the repair.
 - a. When breaking existing longer boards into smaller repairs during removal, use a carpenter's square to mark the cutting area, and score with a razor knife.



- b. Use an oscillating saw to make a precise cut, developing an end-joint. Ensure the newly made end-joint falls within the appropriate stagger from adjoining end-joints.
7. In areas where high humidity is prevalent, or during humid seasons, only remove and replace one board at a time to ensure the existing flooring doesn't close in on the exposed repair area.

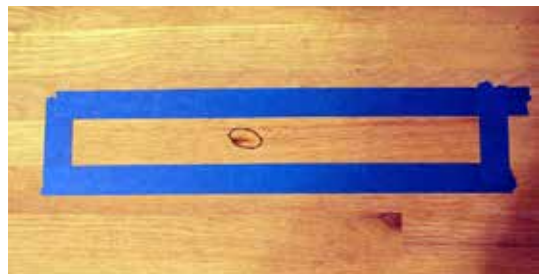

8. Protect adjoining boards from damage with tape, cardboard, or paper, specifically on any previously finished or factory finished floor.

9. Set a circular saw or track saw to the depth of the thickness of the board to be removed. Make one cut inset about 3/8" from the groove-side, running from end-to-end on the board to be removed. Stop the cut approximately 1/8" from the ends of the board. (Alternative tools include a router with the appropriate up-cut bit or an oscillating saw with appropriate wood/metal blade.)
10. Make a second cut inset 3/8" from tongue-side, running from end-to-end on the board to be removed. Stop the cut approximately 1/8" from the ends of the board. (CAUTION: Older floors may have been installed with cut-nails. The blade on a circular saw will not cut through these types of nails. On older floor installations, make first and second cuts approximately 1/2" inside the edges of the boards to ensure not hitting these types of nails.)



11. Make 1-2 additional cuts across the center of the board at a 30-45° angle from the first long cut to the second long cut.



12. With a chisel or oscillating saw, cut through both ends at the cut-lines, and lift out the center of the board. The groove-side piece can now be removed.
13. Carefully remove nails or staples and the tongue-side pieces. Avoid damage to adjoining boards.
14. For glue-down board replacements, carefully remove all board pieces as well as the remaining adhesive from the substrate. Oscillating type saws work great for cuts and glue clean-up.
15. Clean all debris from the area, including from all remaining tongues and grooves.

B. Replacing the damaged nail-down and glue-down flooring (solid or engineered):



1. Measure the opening and then cut the length of the replacement board to size. Cut the butt-end tongue of the new board. When applicable, use miter saw to cut from the bottom of the wear layer to the underside of the material at a 5-10° angle to allow for easier placement.
2. Carefully check the new board against the opening for precise fit.
3. For factory finished flooring with a beveled- or eased-edge, replicate the end-bevel using a saw, router, sand paper, or steel rod (depending on the extremity of the bevel). This may also require color matching and finish replacement on the bevels.
4. From the back side of the replacement board, remove the lower half of its groove side and end match so that it will create a shiplap joint with the tongue of the adjoining boards in the replacement area. Set the table saw or hand plane the underside of the replacement board at an angle to help the board slide into place more easily.





5. Carefully dry fit and loose-lay the replacement board without damage to adjoining boards to check its fit.
6. Check that flooring is relatively flush with surrounding boards. Adjustments to the backside of the replacement board may be necessary where thickness of the replacement product differs from the surrounding boards.
7. Apply liquid or sheet vapor retarder to the exposed substrate as necessary in order to control moisture migration from unconditioned spaces below the floor.
8. For glue down applications, spread approved wood flooring adhesive to the substrate using the notch trowel recommended by the adhesive manufacturer.



9. Apply a fast-setting adhesive to the topside of all adjoining tongues to adjoin the shiplap joint.
10. Insert tongue, and then drive it into place, using a tapping-block and hammer or mallet.
11. Use color putty to fill holes and joints. If unfinished, refinish to match the surrounding flooring.
12. When replacing multiple boards in one area, blind nail the replacement flooring where possible. Follow instructions for remaining installation procedures.

PART III Floating Floor Board Replacement

A. Removal of damaged floating flooring:

1. Individual wood flooring boards can be repaired or replaced in any floated engineered floor without affecting adjoining boards.
2. Make sure you have replacement flooring prior to cutting into the existing floor. The replacement flooring must be the same species, grade, width, edge profile, length, thickness, and cut. The replacement board should also be identified as a glue-together T&G or a locking mechanism.
3. Set your circular saw or track saw just to the thickness of flooring being replaced. Do not cut into or through the underlayment material.
4. Make your first two cuts. The first cut is from end-to-end, parallel with the length of the board at the location of the T&G or locking mechanism. Make your second cut on the opposite side of the board at the location of the opposite T&G or locking mechanism.
5. For easier extraction, an additional diagonal cut (or cuts) may be made across the center of the board from one end to the other, reaching near, but not contacting the surrounding board.
6. Using a sharp chisel or oscillating multi-tool, finish the cuts through top wood layer to the edge of the existing floor, being cautious not to damage the underlayment or adjoining boards.



7. For locking mechanism floors, the center pieces of the cut board should be removed easily, like opening an envelope. Using a sharp wood chisel, remove any remaining pieces (being careful not to damage adjoining boards).
8. For glue-together floors:
 - a. Remove the long sides of the board with a sharp wood chisel. Carefully remove any remaining adhesive from the grooves in the adjoining flooring.
 - b. Carefully scrape off all glue residues from along the factory tongues.

- c. It may be necessary to use a router with the appropriate-sized profile grooving bit to clean out the grooves, and to remove the tongue from the remaining end-joint.
- d. Thoroughly clean all debris from the area.
- e. All tears in underlayment should be taped or replaced with the appropriate underlayment materials.

B. Replacement of floating flooring:

1. Shiplap joints and bridges
 - a. Shiplap joints:
 - i. To create makeshift shiplap joints in the space receiving the replacement board, use a router to develop a groove into all end-joints and long seams of the adjoining boards. The groove size must coincide with the flooring thickness.
 - ii. Glue spline into the end-joints and the long-seam grooves. The opening in the floor should now have four tongues to create a shiplap joint. Clean up any excess glue.
 - iii. Remove the tongues or locking mechanisms from the replacement board.
 - iv. Use a router to develop a groove into all end-joints and long seams of the replacement board, and then remove the underside of the groove on all four sides.
 - b. Bridges:
 - i. Install a bridge on the underside of the adjoining boards. This bridge will allow the replacement board to remain floating within the system.
 - ii. The bridge should be something thin that will not result in peaking of seams between boards (e.g., laminate chips or tongue depressors, etc.).

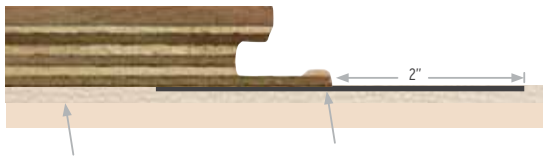

- iii. Glue the bridge to the underside of the adjoining boards on all four sides, and allow it to extend into the workspace opening approximately 2".

- iv. Glue should be compatible with the backing of the flooring and the bridge material for adequate adhesion.
 2. For locking mechanism floors:
 - a. Measure the opening and cut the replacement flooring precisely to length, altering the locking mechanism on the butt-end of the board, as well as along the run of the board.
 - b. The mechanism may need to be replicated or altered to allow for the replacement board to properly fit. Anywhere the locking mechanism has been altered, adhesive will be required. Check with the flooring manufacturer before altering any of the locking mechanisms.
 - c. If you are unable to replicate or modify the existing locking mechanism, you may need to develop a shiplap profile to allow the replacement piece to fit into the opening without damaging adjoining boards.
 - d. Dry-fit the piece and make adjustments as necessary. To reduce the chance of over-wood, use a sharp chisel or block plane to remove material from the underside of the top of the groove of the replacement board.
 - e. Apply a low-viscosity, elastomeric, nonexpanding adhesive along the perimeter membrane that is acting as a bridge on the underside of the board.
 - f. Carefully insert the new board into place, using a wood block and mallet to gently tap into place if necessary.
 - g. Add weight to the board as it dries to avoid any potential lifting after the replacement board has been installed.
 - h. Clean the entire area surrounding the repaired board and ensure the repair is acceptable.
 3. For glue-together floors:
 - a. Measure the opening and cut the replacement flooring precisely to length, removing the tongue or locking mechanism on the butt-end of the board, and the bottom groove side of the replacement board on the butt-end, as well as along the run of the board.
 - b. You may need to chamfer, or back-bevel, the underside of the board where the groove was removed to allow the piece to fit into the opening without damaging adjoining boards.
 - c. The replacement board should have a tongue along the length of the board, and two grooves missing on the underside.

- d. Dry-fit the piece and make adjustments as necessary. To reduce the chance of over-wood, use a sharp chisel or block plane to remove material from the underside of the top of the groove of the replacement board.
- e. Apply a low-viscosity, elastomeric, nonexpanding adhesive along the perimeter membrane that is acting as a bridge on the underside of the board.
- f. Apply the recommended glue (PVA, or quick-setting adhesive, such as epoxy or carpenter's wood glue) to the top side of the tongues of the adjoining boards in the floor.
- g. Carefully insert the new board into place, using a wood block and mallet to gently tap into place if necessary.
- h. Add weight to the board as it dries to avoid any potential lifting after the replacement board has been installed.
- i. Clean the entire area surrounding the repaired board and ensure the repair is acceptable.

PART IV Lace-Out/Lace-In

Lacing is a method used to integrate a new wood floor with an existing wood floor. This is often necessary when extending or adding to an existing wood floor, where removal of the old floor is not the best option, or to replace damaged sections of existing hardwoods.



A. Lace-out

1. Identify the existing flooring installation method. Make sure that you are aware of radiant heat systems or underlayments that may be installed below the flooring.
2. Identify the boards in the existing floor that will need to be removed. This generally will be determined based on the existing pattern of the old floor. When possible, try to remove and avoid "H" patterns and blatant stair-steps.
3. The objective of removal is to not damage adjoining boards and to leave a stagger that flows with the existing floor.

4. Some boards may be easier to remove using alternative methods and tools than those listed in this section.
5. Set your circular saw or track saw to the thickness of the flooring being removed.
6. Be careful not to damage adjoining boards while removing material.
7. Make two cuts along the length of each board being removed.
8. In order to release the board for easier removal, you will need to complete the cuts with a chisel.



9. Carefully extract all of the cut pieces from the area using a hammer, chisel, and pry bar, without damaging the adjacent boards.
 10. Remove or set the remaining fasteners in the subfloor.
 11. When possible, try to leave tongues and grooves intact on remaining boards.
 12. Thoroughly clean all debris from the area.
- B. Lace-in
1. Identify the flooring material being matched. It must be the same species, grade, width, edge profile, bevel, average length, thickness, and cut. Modifications to replacement material may be necessary in some cases.
 2. The new material being laced should be within a minimum of 2% MC of the existing, surrounding flooring.
 3. Existing flooring may not have been installed in the same manner in which the new floor will be installed. It is likely there will be pre-existing conditions that may include gaps between boards, squeaks, inadequate subflooring material, crooked installations, different fasteners, adhesive or other items that could adversely affect the performance of the newly installed flooring. It may be more aesthetically pleasing, and sometimes necessary, to replicate existing installation conditions when lacing into an existing, improperly installed floor.
 4. The new boards are staggered into the existing pattern of the old floor.

5. Where tongues or grooves in the existing flooring have been compromised, it may be necessary to create a shiplap joint between old and new floors. This can be accomplished with a router and the appropriate profile grooving bit to allow for spline to be used as the shelf for the shiplap joint.
6. Where new flooring can be blind-nailed, follow the nailing schedule as detailed in the Nail-Down Installation chapter.



7. Where new flooring cannot be blind-nailed, elastomeric wood flooring adhesive should be used.
8. Where moisture control is necessary, use of a quality wood flooring adhesive, or a liquid-applied moisture retarder may be used.

PART V Addressing Water Damage



When a wood floor has been damaged by a leak or a flood, it must be addressed before further damage occurs. The first step in repairing a water-damaged wood floor is to identify and eliminate the source of moisture. Once the moisture source has been identified and removed, the floor can then be assessed.

- A. It is important to understand that water will migrate to areas below the wood floor system anytime there is a flood.



- B. When water damage occurs, the wood flooring and subflooring systems must be evaluated to determine the extent of damage and ensuing repairs. As a hidden condition, the subfloor may be compromised further than the wood floor above it.

C. Subfloor Materials Evaluation:

1. **Plywood:** swelling, distortion, and delamination can occur when exposed to high levels of moisture. Moisture tests should be conducted using insulated pin, hammer probe-type meters on the surface, on the backing, and within the core of the material in several areas of the damaged material to properly assess the extent of moisture intrusion. Replace when the damage is evident. Ensure replacement material is within acceptable MC ranges prior to reinstallation of wood flooring.
2. **Oriented Strand Board (OSB):** swelling can occur with OSB when exposed to water. Swelling in OSB can create a decrease in density and a reduction in within-board strength due to the release of compaction stress created during the pressing process of manufacturing. This will directly affect how existing fasteners hold the wood flooring to the subflooring material. Replace when damage is evident. Ensure replacement material is within acceptable MC ranges prior to reinstallation of wood flooring.
3. **Concrete:** concrete is a porous material. It typically does not become damaged when exposed to water; however, installed flooring, adhesives, sealers, and other compounds will slow the drying of a wetted concrete slab. Moisture levels must be evaluated and properly addressed prior to installation of new flooring. Concrete substrates should be dried by use of airflow, heat, and dehumidifiers until moisture levels are within the flooring and adhesive manufacturers' required ranges.

D. Wood Flooring Materials Evaluation and Remediation:

1. Identify the type of flooring and installation methods.
 - a. Identify type of substrate.
 - b. Existing materials below the flooring surface may create additional mitigation costs and concerns (e.g., asbestos underlayment, radiant heating systems, etc.).
2. Determine the target moisture content for the geographic area and for the facility.
 - a. Reference the EMC chart.
 - b. Consider the time of year the repairs are to take place and assess the HVAC system's ability to sustain an adequate environment.
3. Conduct moisture testing.
 - a. Use insulated pin, hammer probe-type meters to achieve readings at multiple depths of flooring and subflooring material.
 - b. Use pinless, dielectric meters to scan the flooring surface and map the damage.
 - c. Check existing, unaffected wood for reference.
 - d. Target moisture content should be within 2% of expected "in-use" moisture content.
4. Use dehumidification systems to stabilize the ambient conditions and bring them within the target range.
 - a. Some of the most effective types of dehumidification systems include desiccant systems and low-grain refrigerant systems.
 - b. Dehumidifiers should be placed on the flooring surface as well as below the flooring surface (when applicable).
 - c. Unconditioned areas directly below the wood subflooring system or sleepers, such as basements and crawlspaces, should also be opened to introduce heat and airflow. Any insulation on the underside of the floor joists should also be removed.

5. Many times, minor damage will dissipate or even completely disappear as the flooring dries out over time.
6. Airflow and heat can be used to speed the natural drying process. Care should be taken not to cause collateral damage to other wood products within the drying space when using forced dry air or heat.
7. Vacuum extraction systems include placement of large mats/panels that are attached to vacuum/suction systems designed to pull water from the flooring surface.
8. Negative and positive air pressure systems force airflow beneath and within the flooring systems in order to decrease the moisture content by direct use of airflow.



9. A buckled wood floor requires replacement wherever the buckling has occurred. Once the flooring has buckled, the fasteners or adhesives are no longer effective, and the system will never return to its original state. Once the moisture source has been identified and eliminated, the buckled portion of the flooring may be replaced. The remainder of the flooring should be treated as noted.

GLOSSARY

Abrasion Resistance

That property of a surface that resists being worn away by a rubbing or friction process.

Absolute Humidity

The amount of water vapor present in a unit volume of air, usually expressed as grains/cu.ft.

Absorption

The process by which water is drawn into permeable pores in a porous solid. Also used to indicate the amount of water absorbed by a material, as a percent by weight of a test specimen.

Acceptable Thermal Environment

A thermal environment that a substantial majority (more than 80%) of the occupants find thermally acceptable.

Acclimation

The act of allowing wood moisture content to become at equilibrium with the environment in which it will perform. See Equilibrium Moisture Content (EMC).

ACI 302.2R

A guide by American Concrete Institute (ACI) that contains materials, design, and construction recommendations for concrete slabs-on-ground and suspended slabs that are to receive moisture-sensitive flooring materials. These flooring materials include sheet rubber, epoxy coatings, vinyl composition tile, sheet vinyl, carpet, athletic flooring, laminates, and hardwood. Refer to the most current editions of both ACI 302.1R, "Guide for Concrete Floor and Slab Construction," and ACI 360R, "Design of Slabs-on-Ground," for general guidance on floor design and construction that is needed to achieve successful floor covering performance.

Acid

Chemical substance rated below 7 on the PH scale.

Acid Etching

Application of acid to clean or alter a concrete surface; typically used only when no alternative means of surface preparation can be used.

Acoustical Properties

Absorbance, reflection, or transmission of sound waves generally measured in terms of Impact Insulation Classification (IIC), Sound Transmission Classification (STC) or difference between concrete substrate IIC and IIC of same concrete assembly with finished wood floor installed (Delta IIC).

Adhesion

A chemical process by which two materials can be held together.

Adhesive

A group of materials used to cause similar or dissimilar materials to cohere.

Adjustability Time

The window of time, in a glue-down installation, during which the floor covering can be repositioned without compromising the bond of the adhesive.

Air-Dried

Dried by exposure to air in a yard or shed without artificial heat. Not kiln-dried.

Alkali

Salts of alkali metals, specifically potassium or sodium, occurring in constituents of concrete and mortar, usually in the form of water-soluble hydroxides, which increase the pH of concrete.

Alkali-Aggregate Reaction

A chemical reaction between certain silica or carbonate aggregates and alkali hydroxides in concrete, producing undesirable expansion and cracking.

Alkaline

A measurement of an alkaline rating above 7 on the pH scale.

Anhydrous Calcium Chloride

A white, deliquescent, hygroscopic compound, CaCl₂. A chemical used in ASTM F1869 in the form of prilled beads with a minimum purity of 94%. It can also be used in various technical grades as a drying agent, an accelerator, a deicing chemical, a refrigerant, and to prevent dust.

Anisotropic

Exhibiting different physical properties in different directions.

Annual Growth Ring

The layer of wood growth formed on a tree during a single growing season.

Application Rate (Spread-Rate)

The quantity (mass, volume, or thickness) of material applied per unit area.

ASHRAE (American Society of Heating, Refrigerating and Air Conditioning Engineers)

A building technology society with more than 50,000 members worldwide. ASHRAE's activities include research, standards writing, publishing, and continuing education. Its areas of interest include building systems, energy efficiency, indoor air quality, and sustainability within the industry.

Asphalt-Saturated Felt Paper

A #15 asphalt felt paper that meets ASTM Standard D4869 or asphalt-laminated paper that meets federal specification UU-B-790a Grade B, Type I, Style 1a, or asphalt-saturated paper that meets federal specification UU-B-790a, Grade D, Type I, Style 2. Commonly used as a Class II vapor retarder.

ASTM (American Society for Testing and Materials)

Develops and publishes voluntary technical standards for a wide range of materials, products, systems, and services. ASTM uses a consensus process involving technical committees that draw their members from around the world. ASTM International has no role in requiring or enforcing compliance with its standards, but in many instances, its standards have been adopted by rules-making industry and governmental bodies. Standard designations usually consist of a letter prefix and a sequentially assigned number. This may optionally be followed by a dash and the last two digits of the year in which the standard was adopted. Prefix letters correspond to the following subjects:

- A = Iron and Steel Materials
- B = Nonferrous Metal Materials
- C = Ceramic, Concrete, and Masonry Materials
- D = Miscellaneous Materials
- E = Miscellaneous Subjects
- F = Materials for Specific Applications
- G = Corrosion, Deterioration, and Degradation of Materials

ASTM C39

This test method covers determination of compressive strength of cylindrical concrete specimens such as molded cylinders and drilled cores. It is limited to concrete having a density in excess of 800 kg/m³ [50 lb/ft³].

ASTM C109/C109M

This test method provides a means of determining the compressive strength of hydraulic cement and other mortars and results may be used to determine compliance with specifications.

ASTM C349

This test method covers the determination of the compressive strength of hydraulic-cement mortars, using for the test specimens portions of prisms made and broken in flexure in accordance with Test Method C348.

ASTM C472

These test methods cover the physical testing of gypsum, gypsum plasters, and gypsum concrete. Test methods are detailed for the following: precautions for physical tests, reagents and materials, free water, fineness, normal consistency of gypsum plaster and gypsum concrete, setting time (temperature rise method), compressive strength, and density. Materials include distilled or deionized water and standard sand. For each test method, the following are specified: significance and use, apparatus, and procedure.

ASTM D3498

Standard specification for adhesives for field-gluing wood structural panels (plywood or oriented strand board) to wood based floor system framing.

ASTM D3575

Standard test methods for flexible cellular materials made from olefin polymers.

ASTM D4263 (Plastic Sheet Test)

Standard test method for indicating moisture in concrete by the plastic sheet method. This test method is used to indicate the presence of capillary moisture in concrete.

ASTM D4442 (Oven-Dry Method)

Standard test method for direct moisture content measurement of wood and wood-based materials.

ASTM D4444

Standard test method for laboratory standardization and calibration of handheld moisture meters.

ASTM D4933

Standard guide for moisture conditioning of wood and wood-based materials.

ASTM D4944

Standard test method for field determination of water (moisture) content of soil by the calcium carbide gas pressure tester.

ASTM E1155

Standard test method for determining floor flatness (FF) and floor levelness (FL) numbers. This test method covers a quantitative method of measuring floor surface profiles to obtain estimates of the floor's characteristic FF (flatness) and FL (levelness) face floor profile numbers (F-numbers) using the inch-pound system of units.

ASTM E1745

Standard specification for plastic water vapor retarders used in contact with soil or granular fill under concrete slabs.

ASTM E1993

This specification covers bituminous water vapor retarders for use in contact with soil or granular fill under concrete slabs.

ASTM F710

Standard practice for preparing concrete floors to receive resilient flooring. Note: The ASTM standard also states: "Although carpet tiles, carpet, wood flooring, coatings, films, and paints are not specifically intended to be included in the category of resilient floor coverings, the procedures included in this practice may be useful for preparing concrete floors to receive such finishes."

ASTM F1869 (Calcium Chloride Test)

Standard test method for measuring moisture vapor emission rate (MVER) of concrete subfloor using anhydrous calcium chloride.

ASTM F2170 (Relative Humidity Probe Test)

Standard test method for determining relative humidity in concrete floor slabs using in-situ probes.

ASTM F2659 (Electronic Meters)

Standard guide for preliminary evaluation of comparative moisture conditions of concrete, gypsum cement, and other floor slabs and screeds using a non-destructive electronic moisture meter.

ASTM F3191

Standard practice that describes the procedure for assessing the substrate water absorption (often referred to as substrate porosity) of horizontal substrate surfaces, prior to the installation of resilient floor coverings.

Backing

Layer of the engineered wood floor that provides balance, generally bonded to the bottom of the core layer.

Balanced Construction

An engineered wood plank construction that has materials of similar properties (stiffness, dimensional stability, etc.) bonded to both sides of the product.

Balusters

A vertical member used to in-fill and restrict the size of openings within a balustrade and/or provide support to the top of a balustrade or guard system by transferring a portion of the load applied to the balustrade to the structure of a stair or floor system.

Balustrade

A system of rails, newels, balusters, panels, or other ornamental components used to separate two areas. Balustrades used to minimize falls from elevated walking surfaces and the sides of stairs are also guards.

Banister

A simple post-to-post balustrade typically with small diameter, square or rectangular section balusters used to provide a handrail and minimize falls from the side of stairs.

Base Shoe

A moulding designed to be attached to baseboard moulding to cover expansion space. It is the alternative to a quarter-round in profile.

Basement

A story of a structure that is below grade, or below ground level.

Bevel

An edge of a board that is not perpendicular to the face of the piece of wood flooring, plank, block or parquet. Types of beveled edges may include:

Square edge: Edges with no bevel.

Full bevel: A larger bevel (typically >1/16") 30-45° edges.

Micro bevel: A smaller bevel (typically ≤1/16") 30-45° edges.

Pillowed/eased bevel: A bevel with a slight radius profile.

Chiseled edge: A rough bevel that varies in depth, width, and texture.

Board Foot

A unit of measurement of lumber represented by a board 1 foot long, 12 inches wide, and 1 inch thick, or its cubic equivalent. In practice, the board foot calculation for lumber 1 inch or more in thickness is based on its nominal thickness and width, and the actual length. Lumber with a nominal thickness of less than 1 inch is calculated as 1 inch.

Bond

See adhesion.

Bond Classification

Exposure ratings for wood structural subfloor panels, may be Exterior or Exposure 1. The classifications are based on the severity and duration of weather and moisture exposure the panels are designed to withstand, and the wood materials and adhesives used in manufacture.

Border

Simple or intricate designs that frame and customize a flooring installation.

Bow

The distortion of lumber in which there is a deviation, in a direction perpendicular to the flat face, in a straight line from end-to-end of the piece.

BTU/H (British Thermal Units per Hour)

The amount of heat energy needed to raise the temperature of one pound of water by one degree F, in one hour, expressed in British thermal units per hour.

Builder

Any individual or entity (including, but not limited to, homebuilders, remodelers, general/restoration contractors, DIYers) that coordinates and oversees the different suppliers, trades, installers, and other experts involved in building or remodeling a home, office, or other building.

Building Enclosure

The system or assembly of components, that provides environmental separation between the conditioned space and the exterior environment.

Building Thermal Envelope

The basement walls, exterior walls, floors, roof, and any other building element that enclose conditioned space. This boundary also includes the boundary between conditioned space and any exempt or unconditioned space.

Bullnose

See nosing.

Buyer

Any individual or entity (including, but not limited to, distributors, end-users, installers, flooring contractors, general contractors) that is the first to use/handle/possess/receive/deliver the wood flooring material prior to installation of the wood flooring product.

Calibration

The act of checking and adjusting the accuracy of a measuring instrument. ASTM D4444 is the standard test method for laboratory standardization and calibration of handheld moisture meters.

Capillary Action (Capillary Flow)

The movement of water within the spaces of a porous material (such as concrete) due to the forces of adhesion, cohesion, and surface tension. It is the ability of a liquid to flow in narrow spaces without the assistance of, and sometimes in opposition to, external forces like gravity.

Capillary Break

Layer of no-fines coarse aggregate placed on subgrade soil to stop capillary rise.

Capillary Rise

Action of certain fine-grained soils that can draw water upward from the natural water table.

CARB (California Air Resources Board)

A California state agency that regulates the impact that many industries have on the state's air quality, including controlling emissions for everything from trucks to cows. "CARB P2" refers to "Phase 2" of the Air Toxic Control Measure 93120 (ATCM 93120), which governs formaldehyde emissions from composite wood products. Most engineered and laminate flooring sold in the U.S. will have a CARB P2 compliance statement.

Cement

Any number of materials that are capable of binding aggregate particles together.

Cleat

A barbed fastener commonly used as a mechanical device to fasten hardwood flooring.

Climate

The exterior environmental conditions that will impose a load on the building enclosure, including temperature, humidity, rainfall, wind, and solar radiation. Dividing a map into climate zones allows designers, code bodies, and others to make recommendations based on expected regional loads.

Climate Zone

A geographic region based on climatic criteria as defined by ASHRAE (American Society of Heating, Refrigerating and Air Conditioning Engineers) and as specified in the International Residential Code (IRC).

Color Change

Visual changes in the color of the wood species caused by exposure to light, deprivation of light and air, or some chemical reaction.

Colorfastness

The ability of a material to retain its original color upon exposure to light or other source of degradation (e.g., light resistance).

Composite

A product or system made from two or more constituent materials that remain distinct, but combine to form a material with properties not possessed by any of the individual constituents.

Compression Set

Caused when wood strips or parquet slats absorb excess moisture and expand so much that the cells along the edges of adjoining pieces in the floor are crushed. This causes them to lose resiliency and creates cracks when the floor returns to its normal moisture content.

Concrete

A mixture of Portland cement, water, fine and coarse aggregates. Cement and water form paste that acts as the binding material. Concrete may also contain mineral and chemical admixtures.

Concrete, High-Strength

Concrete that has a specified compressive strength for design of 8000 psi (55MPa) or greater.

Concrete Surface Profile (CSP)

A standardized measure for the roughness, or topography, of a surface that is defined by the International Concrete Repair Institute (ICRI).

Condensation

The change of state from a vapor or gas to a liquid. A common factor in moisture-related damage. Condensation occurs on cool surfaces, when humid air comes into contact with it.

Conditioned Air

Air treated to control its temperature, relative humidity, or quality.

Conditioned Space

An area or room within the building that is intentionally heated or cooled, and humidified or dehumidified, either for the comfort of occupants, or for preserving temperature and humidity-sensitive goods.

Conditioning

Exposure under controlled temperature and relative humidity to bring wood to a desired moisture content.

Contamination, Substrate

Any extraneous material on or within a substrate that can cause deterioration, inhibit bond, or adversely impact performance of any product used in the installation of wood flooring.

Core

The material layer that provides thickness, dimensional stability, and other properties needed for the engineered wood flooring product. Note: The core layer generally consists of wood, finger blocks, HDF/MDF, or any composite material.

Cove

A moulding profile with a concave quarter round radius or arc on the face.

Crack Bridging

The ability of repair or protective surface treatment to remain continuous when installed on a cracked concrete surface.

Crook

The distortion of a board in which there is a deviation, in a direction perpendicular to the edge, from a straight line from end-to-end of the piece.

Cross-Directed

Laying of material perpendicular to the material below it.

Crowning

A convex or crowned condition or appearance of individual strips with the center of the board higher than the edges. The opposite of cupping.

Cupping

A concave or dished appearance of individual boards with the edges raised above the center. The opposite of crowning.

Cure (Concrete)

The process by which a compound attains its intended performance properties by means of evaporation, chemical reaction, heat, radiation, or combinations thereof. The opposite of drying.

Curling/Warping (Substrate)

A deviation of a substrate surface from its original shape, usually caused by either temperature or moisture differentials, or both, within the material or in the zones adjacent to its opposite faces.

Deciduous

See hardwood.

Deflection

The bending of a material between supports when a load is applied.

Deformed Fasteners

Fastener in which the sides are not smooth and the head shape may be irregular. Examples are ring-shank and screw-shank nails.

Degree Days (Cooling and Heating)

Degree days are a measurement designed to reflect the demand for energy needed to heat or cool a building. It is derived from measurements of outdoor air temperature. Degree days are based on the assumption that when the outdoor temperature is 65°F (18°C), we don't need heating or cooling to be comfortable. Degree days are the difference between the daily temperature mean (high temperature plus low temperature divided by two) and 65°F. If the temperature mean is above 65°F, we subtract 65 from the mean and the result is Cooling Degree Days. If the temperature mean is below 65°F, we subtract the mean from 65 and the result is Heating Degree Days.

Design Criteria

Code, standards, loads, displacement limits, materials, connections, details, and protections used in the design of a project in order to be successful.

Dew-Point

The temperature at which the atmospheric water vapor condenses out as a liquid.

Diffuse-Porous Woods

Certain hardwoods in which the pores tend to be uniform in size and distribution throughout each annual ring or to decrease in size slightly and gradually toward the outer border of the annual growth ring. Hard maple is an example.

Diffusion

The movement of individual molecules through a material. The movement occurs because of concentration gradients and (to a much lesser degree) thermal gradients, independent of airflow. A mode of water vapor transport in building enclosures that is much slower than airflow.

Dimensional Change Coefficient

A number that reflects how much a certain species of wood will change in size depending on how it is cut from the tree, in relation to a change in moisture content.

Dimensional Stability

The ability to maintain the original intended dimensions when influenced by a foreign substance. Wood is hygroscopic (readily takes up moisture) and isn't dimensionally stable with changes in moisture content below the fiber saturation point.

Discoloration

Fading or other alterations of a color that changes the normal appearance.

Distressed

An artificial texture in which the floor has been scraped, scratched, or gouged to give it a time-worn, antique look.

Drying (Concrete)

The removal of moisture from concrete usually through evaporation at the surface. Drying is the opposite of curing.

Durability

The ability of the wood species or finish to withstand the conditions or destructive agents with which it comes in contact in actual usage, without an appreciable change in appearance or other important properties.

Efflorescence

A powdery deposit of soluble salts formed by evaporation of water at a concrete surface.

Elasticity

The property of a material that enables it to return to its original size and shape after deformation.

Elastomeric Adhesive

Adhesives with polymers that have rubber-like, elastic properties which permit them to stretch in response to stresses caused by vertical or lateral movement, and then return to approximately its original size and shape.

End-Grain

A slice of wood cut so that the growth rings are facing up, as the transverse cut.

End-Joint

The place where two pieces of flooring are joined together end-to-end.

End-Matched

In tongue-and-groove strip and plank flooring, the individual pieces have a tongue milled on one end and a groove milled on the opposite end, so that when the individual strips or planks are butted together, the tongue of one piece fits into the groove of the next piece. See side-matched and tongue-and-groove.

End User

Any individual or entity that physically receives and puts to use the final wood flooring product.

Engineered Wood Floor

An assembly normally made using multiple wood veneers or slats of wood glued together at opposing directions. Engineered wood flooring is real wood from top to bottom. Composite engineered wood flooring contains real wood on the wearable surface only. The backing and core material may be made up of any type of composite material.

Environmental Protection Agency (EPA)

An independent agency of the United States federal government whose mission is to protect human and environmental health. President Richard Nixon proposed the establishment of EPA on July 9, 1970 and it began operation on December 2, 1970, after Nixon signed an executive order.

Equilibrium Moisture Content (EMC)

The moisture content at which wood neither gains nor loses moisture when surrounded by air at a given relative humidity and temperature.

Ettringite

A hydrous calcium aluminium sulfate mineral that is formed when gypsum comes into contact with a cement-based product. The crystallized minerals increase in volume, filling the voids of the reactants in the latex Portland cement. As the salts grow and expand, they can chemically destroy the integrity of gypsum-based subfloor toppings.

Expansion Gap/Space

A space necessary between fixed objects (e.g., walls of a room, pipes, and cabinets) and between the wood flooring material itself, to allow for the movement of the flooring system.

Factory-Finished

Wood flooring that has been colored and finished at the manufacturer's facility prior to packaging. See also Prefinished.

Fading

The loss of color due to exposure to light, heat, or other destructive agents.

Fastener

A method or device used to attach wood flooring to a subfloor.

Feature Strip

A strip of wood used at a threshold or to border a room or to otherwise serve as an accent. Usually made of a contrasting color or species.

Fence

A device that helps locate and/or guide the workpiece during the cutting process.

Fiber Saturation Point (FSP)

The stage in drying or wetting wood at which the cell walls are saturated with water and the cell cavities (lumina) are empty of free water. It is usually taken as approximately 30% moisture content, based on oven-dry weight.

Fiberboard

A broad generic term inclusive of sheet materials of widely varying densities manufactured of refined or partially refined wood or other vegetable fibers. Bonding agents and other materials may be added to increase strength, resistance to moisture, fire, or decay, or to improve some other property.

Fillets

The small components that comprise finger-block parquet. Also called fingers or slats. Fillet may also refer to the top layer of some engineered wood flooring.

Finger-Block

Parquet made from small strips of wood assembled together. See Fillets.

Fire Resistance

The property of a material or assembly to withstand fire, or give protection from it. Certain species naturally provide greater fire resistance than others. Classes are I-II-III or A-B-C with Class I or A being the most fire-resistant.

Fire Retardant

A chemical or preparation of chemicals used to reduce flammability or to retard the spread of a fire over a surface.

Flame Spread

The propagation of a flame away from the source of ignition across the surface of a liquid or solid, or through the volume of a gaseous mixture. Note: Most wood species are Class C Flame Spread unless the wood floor has been treated and marked as to flame spread.

Flash-Time

In a glue-down installation, with some types of flooring adhesives, flash-time is the recommended amount of time for a freshly applied adhesive to remain exposed to the air before the installation of floor covering should begin.

Floating Floor

A floor that does not need to be nailed or glued to the subfloor. Typically, the flooring panels are connected together by glue or a locking mechanism.

Floor Temperature

The surface temperature of the floor where it is in contact with the occupants' feet.

Formaldehyde

Formaldehyde is a naturally occurring substance that is naturally created by our bodies and can be found in food such as apples or spinach. Generally, formaldehyde becomes a concern when in a gaseous form and too much is inhaled. Formaldehyde is used in a wide variety of industries and, in the wood flooring industry, is a common component in adhesives where it is usually bonded with another chemical to create a compound (an example would be "phenol formaldehyde"). Sometimes the chemical bond will break and what is known as "free formaldehyde" will be released as a volatile organic compound (VOC) into the air. There are a number of regulations limiting the emission of formaldehyde from composite wood products.

Grade

A reference plane representing the finished ground level adjoining the building structure at all exterior walls.

Grain Angle

A description of how the wood was cut from the tree, related to the orientation of the growth rings with respect to the wide face of the board.

Ground Fault Circuit Interrupter (GFCI)

A safety device designed to sense electrical leakage to ground and quickly shut off the circuit to prevent electrical shock.

Guard

A protective device that forms a barrier between a hazardous object such as a moving blade, wheel, or cutter, and the operator.

Hardened Steel Pin

Specialty fasteners designed to penetrate and hold concrete, steel, and other substrates. Steel pins typically are installed with powder, pneumatic, or gas-powered tools.

Hardness

That property of the wood species or dried film of finishing material that causes it to withstand denting or being marked when pressure is exerted on its surface by an outside object or force.

Hardwood

Generally, one of the botanical groups of deciduous trees that have broad leaves, in contrast to conifers or softwoods. The term has no reference to the actual hardness of the wood.

HDF (High Density Fiberboard)

See MDF (medium density fiberboard).

Heating Degree Day (HDD)

Heating degree day is a measurement designed to quantify the demand for energy needed to heat a building. HDD is derived from measurements of outside air temperature. The heating requirements for a given building at a specific location are considered to be directly proportional to the number of HDD at that location.

Humidistat

A regulatory device, actuated by changes in humidity, used for automatic control of relative humidity.

Humidity

A general reference to the moisture content of the air. It is expressed in terms of several thermodynamic variables, including vapor pressure, dew-point temperature, wet bulb temperature, humidity ratio, and relative humidity. It is spatially and temporally averaged in the same manner as air temperature.

HVAC (Heating, Ventilation, and Air Conditioning) System

A system that maintains desired environmental conditions in a space. HVAC systems are categorized by the method used to produce, deliver, and control heating, ventilating, and air conditioning in the conditioned area.

Hydration

A chemical reaction between water and cement compounds that produces a hard, rock-like mass, and develops strength in concrete. Curing aids hydration whereas drying stops hydration.

Hydrostatic Pressure

Fluid pressure that develops when the liquid water level is above a specified location.

Hygrometer

An instrument for measuring the degree of humidity or relative humidity of the atmosphere.

Hygroscopic

A substance that can absorb and retain moisture, or lose or throw off moisture. Wood and wood products are hygroscopic. They expand with absorption of moisture and their dimensions become smaller when moisture is lost or thrown off.

Hysteresis

The phenomenon in which the value of a physical property lags behind changes in the effect causing it. In wood, the equilibrium moisture content (EMC) that wood attains at any given relative humidity and temperature combination depends upon many variables, including the direction from which the EMC is approached. During desorption (moisture loss), the EMC will be higher (sometimes by several percent moisture content) than during adsorption (moisture gain).

Impact Resistance

The ability to resist fracture or damage from a falling object.

In-Situ

A Latin term that means “in place” or “on site,” the term applies to testing done on site, or on materials in their original location, as opposed to testing done in a laboratory. Some sound control testing is done in the field or “in-situ,” and relative humidity testing in the concrete slab is often done using “in-situ” probes.

Inlay

A decorative effect used in flooring by combining elements of the same material, but with different colors or patterns (e.g., borders or feature strips).

Installer

Any individual or entity that physically installs and places into service the wood flooring product.

Intensity

The intensity of a color is its purity or degree of hue as seen by the eye.

International Building Code (IBC)

A model building code developed by the International Code Council (ICC) adopted throughout most of the United States.

International Code Council (ICC)

A membership association dedicated to building safety and fire prevention, develops the International Codes, model building codes used to construct residential and commercial buildings, including homes and schools.

International Residential Code (IRC)

A comprehensive, stand-alone residential code that creates minimum regulations for one- and two-family dwellings of three stories or less. It brings together all building, plumbing, mechanical, fuel gas, energy, and electrical provisions for one- and two-family residences.

Joint (Concrete)

A physical separation in concrete, including intentionally made cracks that occur at specified locations.

Joint, Construction (Cold Joint): Used where two successive placements of concrete meet. This cold joint becomes a weakened joint that will crack when either slab moves.

Joint, Contraction (Control or Saw-Cut Joints): Formed, sawed, or tooled grooves in the concrete slab used to induce shrinkage cracking at specific locations.

Joint, Expansion: Joints that allow for movement where expansion is likely to exceed contraction. Expansion joints are normally filled with compressible filler material allowing for independent movement between adjoining slabs.

Joint, Isolation: A separation between adjoining parts of a concrete structure, usually a vertical plane, at a designated location used to prevent a bond and allow movement between the slab and the adjoining structure.

Jointed Flooring

Strip flooring, generally birch, beech, hard maple, or pecan, manufactured with square edges, not side-matched, but usually end-matched. It is used principally for factory floors where the square edges make replacement of strips easier.

Joist

One of a series of parallel beams used to support floor or ceiling loads and supported in turn by larger beams, girders, or bearing walls.

Kerf

Describes the thickness and blade-width of the cut a saw blade makes in a piece of wood as it cuts through it.

Kerfing

A wood bending technique using a series of uniform, shallow cross cuts on the back of a board that do not penetrate the face allowing the back surface to compress to a smaller radius increasing the flexibility without reducing the thickness.

Kickback

Sudden and unintended movement of the tool or workpiece. It is typically caused by binding or pinching of the workpiece.

Kiln

A chamber having controlled air flow, temperature, and relative humidity for drying lumber, veneer, and other wood products.

Kiln-Dried

Dried in a kiln with the use of artificial heat.

Laminate Flooring

A rigid floor covering, typically in a plank or tile format, having a multiple layer product structure (e.g., overlay, décor, core, and backer). The planks/tiles have worked edges that allow the product to be joined together to form a larger integral unit. The product may vary in surface texture and gloss. Laminate flooring does not include products having a resilient, stone, textile, wood, leather, or metal top surfacing materials.

Landing

1. The space at the top and bottom of a flight at a floor level to provide clear approach to the stair or the floor level from the stair. 2. An intermediate platform between flights used to change direction of the stair and/or provide a resting place, typically with dimensions approximating the width of the flights served.

Landing-Tread

1. The top tread in a flight supported by the top riser that is attached in alignment with the floor-surface with the same nosing projection as the treads in the flight below. 2. The moulding used as landing tread and landing nosing. (Also known as bullnosing, or stair-nosing.)

Lightweight Aggregate

Manufactured aggregate such as expanded or sintered clay, slate, or shale, having low density and used to produce lightweight concrete. Lightweight aggregate often has significantly higher absorption and therefore holds more water in a concrete mix than does normal-weight aggregate.

Live Load

A moving load on a structure.

Livesawn

A method of sawing a log straight through its diameter, leaving in the heart of the log, and all of the grain and character variations seen throughout all grades and cuts of lumber.

Load Factor

A factor by which a service load is multiplied to determine a factored load used in the strength-design method.

Load Test

Procedure consisting of applying loads to verify the strength and behavior of a structure or structural member.

Manufacturer

Any individual or entity that physically manufactures a product, or has a product designed or manufactured for the wood flooring industry, and places it on the market under its' own name or trademark.

Manufacturing Defect

Includes all defects or blemishes that are produced in manufacturing, including, but not limited to, chipped grain, torn grain, skips in dressing, hit-and-miss (a series of surfaced areas with skips between them), variation in machining, machine burn, and mismatching.

Mechanical Fastener

A mechanical device such as a cleat or staple or nail specifically designed for the purpose of installing wood flooring. The fastener is coated (staples) or serrated (nail/cleats) to increase the holding power. The fastener typically is used within the "pocket" of the tongue at the point that horizontal portion of the tongue becomes the vertical edge of the wear layer. Some specialty flooring use face nailing only while other specialty products may allow for positioning the fastener in the groove side.

Medium Density Fiberboard (MDF)

A core material primarily composed of cellulose fibers combined with synthetic resins or other suitable bonding systems under heat and pressure. The materials are usually designated as low-, medium-, or high-density (e.g., LDF, MDF, or HDF). Note: High density fiberboard (HDF): A fiberboard with density greater than 800 kg/m³ (50 lb./ft.³).

Membrane, Liquid

A liquid material applied to a substrate to form a continuous moisture control film after it cures.

Membrane, Sheet-Goods

Any functionally continuous flexible structure of felt, fabric, plastic, rubber, mat, pad, or combination thereof used as a moisture control system.

Meter Drift

The decrease (or increase) in true moisture content over a specified elapsed time.

Mill Thickness Declaration

Designated wood panel subfloor thickness subject to tolerances as specified in the PS standard.

Mineral Spirits

A solvent product used as a thinner and/or cleaner.

Mixed Media

A wood floor that is made predominately of wood, but also incorporates other materials, such as stone, ceramic, leather, or metal.

Moisture Content

The amount of moisture in wood expressed as a percentage of the weight of oven-dried wood. NWFA/NOFMA hardwood flooring is manufactured at 6 to 9 percent moisture content, with a 5 percent allowance for pieces up to 12 percent moisture content.

Moisture Meter

A tool used for the rapid determination of moisture content in wood by electrical means. There are two main types of meters: pinless meters (dielectric) and pin-type meters (electrical resistance).

Monolithic

A system wherein the individual components react together as a uniform, continuous mass.

Muriatic Acid

A diluted acid used to neutralize alkalinity of concrete subfloors.

NAF (No Added Formaldehyde)

NAF indicates that no formaldehyde was added to the product during manufacturing. The term NAF may be used to indicate a route to TSCA/CARB compliance for a manufacturer, or used as a designation on products indicating emissions status, or as a qualifier for some green building credit categories.

Nailing Shoe (Nailing Plate)

An attachment to a floor nailer that broadens the impact area on the floor surface.

Newel or Newel Post

1. A vertical element or post used to connect balustrade components to the structure of a stair or floor system. 2. A vertical post to which carriages, stringers, and balustrades can be attached at junctions and angular turns in the stairway to provide the main support for the stairs and balustrades.

NIST (National Institute of Standards and Technology)

A physical sciences laboratory, and a non-regulatory agency of the United States Department of Commerce. Its mission is to promote innovation and industrial competitiveness.

NOFMA

Formerly the "National Oak Flooring Manufacturer's Association," and then the "Wood Flooring Manufacturer's Association." Currently NOFMA is the wood flooring mill certification program administered by the NWFA. NOFMA certification provides an assurance that wood flooring meets or exceeds industry standards for grade, configuration, moisture content, and average board length. Certified mills are inspected a minimum of twice per year to ensure grading standards are consistently met.

Nominal Size

As applied to timber or lumber, the size by which it is known and sold in the market, often different from actual size.

Nondestructive Evaluation (NDE)

Condition evaluation conducted with nondestructive methods.

Nondestructive Testing (NDT)

Includes, but is not limited to, the examination of materials and structures in ways that do not impair future usefulness and serviceability in order to detect, locate, and measure discontinuities, defects, and other imperfections to assess integrity, properties, and uniformity, and to measure geometrical characteristics.

Oriented Strand Board (OSB)

Commonly used as an underlayment or subfloor material. Strands tend to be oriented with their length aligned with the panel length (typically). OSB is therefore stiffer and stronger when installed with the long axis across supporting floor joists.

Oriented Strand Board (OSB), High-Performance

Some OSB products have obtained a third-party evaluation documenting greater strength and stiffness compared to either plywood or commodity OSB by virtue of their engineered design and makeup.

OSHA (Occupational Safety and Health Administration)

An agency of the United States Department of Labor. Congress established the agency under the Occupational Safety and Health Act, which President Richard M. Nixon signed into law on December 29, 1970. The Occupational Safety and Health Act of 1970 is a U.S. labor law governing the federal law of occupational health and safety in the private sector and federal government in the United States (www.osha.gov).

Osmosis

Movement of water through a semipermeable membrane into a solution of higher salt concentration that tends to equalize the concentrations of salt on the two sides of the membrane. Blisters under some floor coatings can form due to osmosis where concrete can act as a semipermeable membrane.

Outdoor Design Condition

The local outdoor environmental conditions, represented by climate data, at which a heating or cooling system is designed to maintain the specified indoor thermal conditions.

Overwood/Underwood

A flooring condition in which there is a perceived misalignment of the flooring surface, with some wood pieces raised above adjacent pieces leaving a slightly uneven surface.

Panel Grade

The term “grade” may refer to panel grade or veneer grade. Panel grades generally are identified in terms of the veneer grade used on the face and back of the panel (e.g., A-B, B-C, etc.) or by a name suggesting the panel’s intended end-use (e.g., APA-rated sheathing, underlayment, etc.).

Parquet

Wood flooring composed of wooden blocks arranged in a geometric pattern.

Particle Board

A generic term for a material manufactured from wood particles or other lignocellulosic material and a synthetic resin or other suitable binder. Flake board is a particle panel product composed of flakes. Oriented strand board is a type of particle panel product composed of strand-type flakes that purposely are aligned in directions that make a panel stronger, stiffer, and with improved dimensional properties in the alignment directions, making it appropriate for some wood flooring installations. Wafer board is a particle panel product made of wafer-type flakes. It usually is manufactured to possess equal properties in all directions parallel to the plane of the panel, but is not appropriate for most wood flooring installations.

Performance Category

A panel designation related to the wood panel thickness range that is linked to the nominal panel thickness designations used in the International Building Code (IBC) and the International Residential Code (IRC).

Perm

The mass rate of water vapor flow through one square foot of a material or construction of one grain per hour induced by a vapor pressure gradient between two surfaces of one inch of mercury or in units that equal flow rate.

Perm Rating

The standard measure of the water vapor permeability of a material. The higher the number, the more readily water vapor can diffuse through the material.

Permeability

The rate of water vapor transmission through a flat material, expressed in units of mass, per area, per thickness, per vapor pressure difference across the material.

Permeance

The rate of water vapor transmission through a flat material under specified conditions of specimen thickness, area, and vapor pressure difference. The unit of measurement is typically the “perm.” Perm ratings of materials are actually permeance values for a product of specified thickness, while permeability is a numerical value per unit of material thickness.

pH

A logarithm of the reciprocal of hydrogen ion concentration in moles per liter, used to express the acidity or basicity of a solution on a scale of 0-14, where less than 7 represents acidity, 7 is neutral, and more than 7 is basic.

Photo-Sensitive

The property of some wood species that causes them to lighten or darken when exposed to light. See Color Change.

Pith

The small, soft core occurring near the center of a tree trunk, branch, twig or log. First growth.

Plainsawn (Flatsawn)

Cut parallel to the growth rings. Wood flooring cut so that the growth rings are mostly parallel (0° to 45°) to the wide face of the board (a tangential cut). This cut is called plainsawn in hardwoods, and flatsawn in softwoods.

Plank

Solid or engineered wood flooring manufactured in linear widths measuring from 3” up to 5”.

Plenum

A chamber that forms a part of the air circulation system other than the occupied space being conditioned.

Plugs

Used to cover countersunk fasteners and/or for decorative purposes when installing wood flooring.

Plywood

Board or panel made of cross-directional veneers and/or layers of wood for dimensional stability.

Point Load

An equivalent load applied to a single point on a floating wood floor, which you can determine by calculating the total load over an individual plank's surface and attributing the entire load to its center.

Porosity

Voids in a solid substance, often expressed as a volume percent. The connectedness of voids, along with other properties of the substance, determines permeability.

Post-Tensioning

A method of concrete prestressing in which internal or external prestressing tendons are tensioned after the concrete has hardened.

Power Source

A household workplace electrical outlet, battery, or generator providing the electricity to your tool. The power source must be compatible with the requirements found on the tool's rating plate: voltage, amperage, AC or DC, and frequency.

Prefinished

Wood flooring that has been finished prior to being installed. Also see Factory Finished.

Pre-Tensioning

A method of prestressing reinforced concrete in which the tendons are tensioned before the concrete is placed.

Product Standard (PS)

A wood panel industry product manufacturing or performance specification. Voluntary Product Standard PS1 for Construction and Industrial Plywood was developed cooperatively by the plywood industry and U.S. Department of Commerce. Voluntary Product Standard PS2, Performance Standard for Wood-Based Structural Use Panels, establishes performance criteria for specific designated construction applications.

Push-Block/ Push-Stick

A suitably shaped and designed hand-held device used to push the workpiece into and past cutting edges on stationary power tools.

Qualitative Test

A test method that produces information about qualities without determining a verifiable value. Examples of qualitative tests include ASTM F2659 and ASTM D4263.

Quantitative Test

A test method that produces data that measures the quantity of something that can be verified. Examples of quantitative tests include ASTM F2170 and ASTM F1869.

Quartersawn (Vertical Grain)

Cut perpendicular to the growth rings. Wood flooring cut so that the growth rings are mostly perpendicular (45° to 90°) to the wide face of the board (a radial cut). This cut is called quartersawn in hardwoods, and vertical-grain in softwoods.

R-Value (Thermal Resistance)

The inverse of the time rate of heat flow through a body from one of its surfaces to the other surface for a unit temperature difference between the two surfaces, under steady state conditions, per unit area. The higher the R-value, the more resistant to heat loss the insulation product is.

Rays

Strips of cells that run from the bark toward the center of the tree. The rays serve primarily to store food and help move sugars and other materials from pith to bark. Because they are actually a second system of live cells running perpendicular to the grain, they can contribute visual interest to finished flooring depending on how the boards are cut from the tree.

Reducer Strip

A teardrop-shaped moulding accessory for hardwood flooring, normally used at doorways, but sometimes at fireplaces and as a room divider. It is grooved on one edge and tapered or feathered on the other edge.

Relative Humidity

Ratio of the amount of water vapor present in the air to that which the air would hold at saturation at the same temperature. It usually is considered on the basis of the weight of the vapor, but for accuracy, should be considered on the basis of vapor pressures.

Returned-End

The end of a moulding profile that has been mitered to extend the profile across the end and conceal the end grain.

Revolutions per Minute (RPM)

For a tool that rotates an accessory (drill, saw, router), RPM is the number of complete turns the accessory makes in one minute.

Riftsawn (Bastard Sawn)

Cut neither parallel nor perpendicular to the growth rings. Wood flooring cut so that the growth rings make angles of 30° to 60° to the face of the board. This cut is known as riftsawn or bastard sawn.

Ring-Porous Woods

A group of hardwoods in which the pores are comparatively large at the beginning of each annual growth ring and decrease in size, more or less abruptly, toward the outer portion of the annual growth ring. The large pores are springwood and the smaller pores are summerwood.

Ring Shank

Nail headed nail for underlayment installation with rings on the shaft (shank) to improve the holding characteristics.

Screed/Sleeper

Wood members laid over a substrate, and perpendicular to the finished floor, providing a nailing surface. Usually a 2"x4" (50mmx100mm) piece of wood laid on-end, embedded in concrete, or laid flat side down and attached to a concrete subfloor.

Seller

Any individual or entity (including, but not limited to, retail stores, big box stores, internet sales, interior designers, vendors, direct sales) that physically supplies/sells the wood flooring products to the buyer.

Sheathing

The structural covering, usually sheets of plywood or OSB, placed over exterior studding, rafters, or subfloors.

Shoe Moulding

A convex-shaped quarter round moulding, used at the joint between base and floor.

Side-Matched

In tongue-and-groove strip and plank flooring, the individual pieces have a tongue milled on one side and a groove milled on the opposite side, so that when the individual strips or planks are placed side by side, the tongue of one piece fits into the groove of the next piece.

Slip-Tongue/Spline

A small strip of wood or metal used to reverse or change direction in installing standard tongue-and-groove strip flooring.

Softwoods

Generally, one of the botanical groups of evergreen coniferous trees that have needles and are cone-bearing. The term has no reference to the actual hardness of the wood.

Solid Wood Floor

A solid piece of wood from top to bottom.

Span Rating

Two numbers separated by a slash. The left-hand number is the maximum recommended center-to-center spacing for supports in inches when the wood panel is used for roof sheathing with long dimensions across supports. The right-hand number is the maximum center-to-center spacing of supports in inches when the panel is used for subflooring with the long dimension across supports. They are based on application of the panel with the long dimension or strength axis across three or more supports.

Species Correction

A moisture meter-manufacturer-specified, user-adjusted setting that is made to the moisture meter to compensate for either varying electrical properties (for pin-type meters) or densities (for pinless meters) of the species under test, as compared to the species of the reference calibration.

Specifier

Any individual or entity including, but not limited to, architects, builders, consultants, design centers, interior designers/decorators, end-users, general contractors, flooring contractors, or sales professionals that recommends, specifies, or in any way advises the buyer prior to ordering, purchasing, and/or installing the wood floor products.

Square Edge

Flooring that abuts without a broken plane.

Squares

Parquet flooring units, usually composed of an equal number of slats.

Stack/Chimney Effect

The natural movement of air in a home from low levels (basement/crawl space) to upper levels (second story). Natural convection draws air from the crawl space up into the living spaces.

Stair

A step or change in elevation of one or more risers.

Stair-Nosing

A hardwood moulding used to cover the outside corner of a step, milled to meet the hardwood floor in the horizontal plane, to meet the riser in the vertical plane. It is usually used on landings. (Also known as bullnosing or landing-tread.)

Stair-Nosing Projection or Overhang

The horizontal distance measured from the leading edge of the tread to the trailing edge of the tread below.

Stair-Nosing, Return

A moulding matching the nosing moulding profile and projection of the tread nosing that is mitered to the tread nosing and used to project the end of a returned tread over the cut string face with identical detail to the projection of the tread nosing past the riser face.

Stair Riser

The vertical component of a step filling the space between the treads.

Stair Tread

The horizontal part of a stair upon which the foot is placed.

Stairbuilder

A person with skills specific to the arts of designing and constructing stairways and balustrades.

Staircase

That part of the building set apart for the stairs and balustrade generally including the well opening and adjacent walls.

Strip

Solid or engineered wood flooring manufactured in linear widths measuring less than 3”.

Subfloor/Substrate

A preexisting supporting surface used in a building or structure over which a wood floor can be installed. May include wood panel, solid wood, concrete, lightweight concrete, screeds/sleepers, or existing flooring materials.

Supplier

Any individual or entity including, but not limited to, distributor, wholesaler, or importer that receives product from a manufacturer and supplies the wood flooring products to a reseller or buyer.

Surface

The outside or exterior boundary of any substance. One is said to surface the wood when it is rubbed or sanded to a smooth, level plane.

Surface Profile

The topographic contour of the exposed surface of a material or substrate.

T-Moulding (Saddle)

A flat moulding with beveled or rounded edges designed to transition between two surfaces of the same height. Often used to cover expansion at doorways and typically attached to the surface of the flooring products.

Temperature

A measurement that indicates how hot or cold something is. The United States uses the Fahrenheit (°F) scale. The majority of the rest of the world uses the Celsius (°C) scale.

Temperature Correction

The adjustment that is made to the pin-type moisture meter reading to compensate for the phenomena that the electric conductance of wood increases as the temperature increases, and vice-versa.

Tensile Strength

A value arrived at to demonstrate how much tension is acceptable until failure is achieved with a vapor retarder. Failure can be described as a fracture or tear.

Thermal Comfort

That condition of mind that expresses satisfaction with the thermal environment and is assessed by subjective evaluation.

Thermal Load

Load on a structure created by changes in temperature, measured in watts. Effectively, the thermal load is the amount of energy (heat) that needs to be added or removed from a house to maintain a regular temperature and control moisture, a job usually performed by a house’s HVAC system. Sources that affect thermal load are the outside air temperature, indoor air temperature, underground temperature, solar radiation, and heating and cooling (HVAC) equipment.

Tongue-and-Groove

In strip, plank, and parquet flooring, a tongue is milled on one edge and a groove cut on the opposite edge. As the flooring is installed, the tongue of each strip or unit is engaged with the groove of the adjacent strip or unit.

Toxic Substances Control Act (TSCA)

A federal law that passed in 1976. Amendments are referred to as “Titles” and are usually written with roman numerals. TSCA Title VI is the short form for “The Formaldehyde Emission Standards for Composite Wood Products Act of 2010.” TSCA Title VI is enforced by the US Environmental Protection Agency (EPA) and applies to all composite wood products that are sold, supplied, offered for sale, manufactured, or imported into the United States.

Trim

The finish materials in a building at the floor of rooms (baseboard, base shoe, quarter round, for example).

Truss

Engineered or solid floor joist system.

ULEF (Ultra-Low Emitting Formaldehyde)

May be a route to TSCA/CARB compliance for a manufacturer. May be a designation on an adhesive or a product indicating emissions status. May be a qualifier for a green building credit category.

Unconditioned Space

The exterior spaces or a space within the shell of a building that is neither directly nor indirectly heated nor cooled.

Underlayment

A material used between the wood flooring and the subfloor, normally used to control moisture or sound transmission.

Unfinished

A wood flooring product that must have stain and/or a finish applied after installation.

Vapor Barrier

No material is truly a barrier. A vapor barrier is a layer of material that is used to prevent the transfer of water or water vapor from the environment into a constructed structure. It is essentially vapor impermeable (e.g., metal, glass, thick plastics, and unperforated epoxy paint). A vapor barrier is defined by some as a Class I vapor retarder, a material that has a permeance of 0.1 or less. The test procedure for classifying vapor barriers is ASTM E-96 test method A (the desiccant or dry cup method).

Vapor Diffusion

The movement of water vapor through vapor-permeable materials.

Vapor Diffusion Retarder (VDR)

A layer of material, either preformed or liquid-applied, that is used to control the rate at which moisture can move through a material.

Vapor Impermeable Membrane (Class I Vapor Retarder)

Materials with a permeance of 0.1 perm or less, when tested in accordance with ASTM E-96 test method A (the desiccant or dry cup method). Class I vapor retarders are also known as vapor barriers.

Vapor Permeable Membrane

Materials with a permeance of greater than 10 perms, when tested in accordance with ASTM E-96 test method A (the desiccant or dry cup method).

Vapor Permeance

A layer property that describes the ease with which vapor molecules diffuse through it. More specifically, vapor permeance is defined as the quantity of vapor flow across a unit area that will flow through a unit thickness under a unit vapor pressure difference.

Vapor Semi-Impermeable (Class II Vapor Retarder)

Materials with a permeance of 1.0 perm or less and greater than 0.1 perm, when tested in accordance with ASTM E-96 test method A (the desiccant or dry cup method).

Vapor Semi-Permeable (Class III Vapor Retarder)

Material with a permeance of 10 perm or less and greater than 1.0 perm, when tested in accordance with ASTM E-96 test method A (the desiccant or dry cup method).

Volatile Organic Compound (VOC)

Organic chemicals that have a high vapor pressure at ordinary room temperature. Simply put, they exist in gaseous form in the air around us. VOCs include both human-made and naturally occurring chemical compounds. The health effects caused by specific VOCs will depend on the concentration and length of exposure.

Water-Cement-Ratio (w/c)

Mass of water to mass of cement in a concrete mix, expressed as a ratio.

Water Vapor

The invisible, gaseous state of liquid water.

Wear Layer

The outermost layer of engineered flooring designed to be the visible side when installed.

Wide-Plank

Solid or engineered wood flooring manufactured in linear widths measuring greater than 5”.

Wood Floor

Wood is the hard fibrous material that forms from the main substance of the trunk or branches and beneath the bark of a tree. A wood floor is any flooring product that contains real wood as the top-most, wearable surface of the floor.

Working Pressure

The pneumatic pressure range specified in pounds per square inch (PSI) to optimally run an air tool.

Working Time

The maximum amount of time, in a glue-down installation, that an adhesive can remain exposed to the air, and still effectively bond to the floor covering. This time may vary based on temperature, humidity, substrate porosity, trowel size, and jobsite conditions.

SOURCES AND CREDITS

Technical Standards Committee

- Brett Miller, NWFA Staff Liaison
- Charlie Peterson, CP Hardwood Floors
- Hank Adams
- Joe Audino, Rode Brothers Floors
- Jon Namba, Namba Services
- Kevin Mullany, Benchmark Wood Floors
- Michael Harde, Carlisle Wide Plank Floors
- Steve Marley, Johnston Premium Hardwood Flooring
- Tony Miraldi, Somerset

Safety Reviewers and Contributors

- California Air Resources Board (CARB)
- Elizabeth Baldwin, Metropolitan Floors
- Jim Schumacher, 3M
- National Electric Code (NEC)
- Occupational Safety and Health Administration (OSHA)
- Power Tool Institute, Inc., "Safety is Specific" publication
- The U.S. Environmental Protection Agency (EPA)

Jobsite Conditions Reviewers and Contributors

- ©ASHRAE www.ashrae.org: "ANSI/ASHRAE/IESNA Standard 90.1-2007 Normative Appendix B - Building Envelope Climate Criteria"
- ©ASHRAE www.ashrae.org: optimum RH for Health, Vol. 91, Part 1, 1985
- "Insulating Raised Floors in Hot, Humid Climates," LSU AgCenter Pub. 3187
- Joe Lstiburek, Building Science Corporation
- "Moisture in Crawl Spaces," Anton TenWolde, and Samuel V. Glass, PhD.
- U.S. Dept of Agriculture, Forest Products Lab. (Tech Line, Crawl Space Ventilation)
- U.S. Environmental Protection Agency (EPA); "Moisture Control Guidance for Building Design, Construction and Maintenance"

Moisture Testing Reviewers and Contributors

- Andrew and Kelvin Rynhart, Tramex Ltd.
- Grete Heimerdinger, Lignomat
- Jason Spangler, Wagner Meters
- Tom Laurenzi, Delmhorst Instruments Co.

Wood Subfloors Taskforce Reviewers and Contributors

- Alex Kuchar, Weyerhaeuser
- BJ Yeh, APA
- Brett Miller, NWFA Staff Liaison
- Bryan Readling
- Craig Dupra, Installers Warehouse
- Christopher Vegas, Huber Engineered Woods
- Curtis Richard, Primattech
- Dominique Dion, Primattech
- J. Pu, Huber Engineered Woods
- Jeff Jayne, Louisiana Pacific Corporation
- Jerry Eidson, Huber Engineered Woods

- Keith Cudmore, Metropolitan Flooring
- Kjell Nymark
- Mark Halverson, APA
- Michael Pyle, Huber Engineered Woods
- PFS TECO (PFS Corporation and Timberco Inc.)
- TPI (Timber Products Inspection)
- Travis Bjorkman, AHF
- U.S. Environmental Protection Agency, "Moisture Control Guidance for Building Design, Construction and Maintenance"

Concrete Subfloors Reviewers and Contributors

- Andrew Rynhart, Tramex Ltd.
- ASCC (American Society of Concrete Contractors) as published in "Concrete International, a publication of the American Concrete Institute"
- Chad Bulen, Bostik
- "Concrete Slabs and Moisture Issues" by Howard Kanare, March 2004
- Dave Darche, Bona U.S.
- Jason Spangler, Wagner Meters
- Ken Lozen, International Concrete Repair Institute, Inc. (ICRI)
- Len Daubler, Shaw Floors
- Mark Lamanno, Titebond/Franklin Adhesives
- Mike Croes, Sika AG
- Peter Craig, Concrete Constructives
- Portland Cement Association (PCA)
- Ray Kaligian, USG Corporation
- Steve Lima, Mapei

Screeds/Sleepers Taskforce Reviewers and Contributors

- Brett Miller, NWFA Staff Liaison
- Daniel Saucedo, Daniel Wood Floors
- Gary Zak, All Brite Floors
- Greg Schenck, Schenck and Company
- Jay Atkinson, Atkinson Floors
- Mark Battaglini, Trinity Hardwood Distributor
- Neil Moss
- Rick Jones, Rick Jones Inspections
- Will Tremino, Tex-wood Hardwood Distributors

Moisture Control Underlayments Reviewers and Contributors

- APA: Technical Note J450, Water Vapor Permeance of Wood Structural Panels and Wood Wall Construction
- APA: Technical Topics TT-111A
- ©ASHRAE www.ashrae.org: ANSI/ASHRAE/IESNA Standard 90.1-2007 Normative Appendix B - Building Envelope Climate Criteria.
- IRC (2009) Moisture Control - Floors. Sec. 502.1.6.2 Washington State Energy Code (WSEC) 2009
- Insulations, Sheathings and Vapor Retarders - Joseph Lstiburek Research Report - 0412 November, 2004
- International Code Counsel (ICCSafe.org) Tech Note - Vapor Retarders: Reducing Moisture Risk in Frame Walls
- Jack Boesch, MP Global
- Joe Lstiburek, BSD-106: Understanding Vapor Barriers

- Joe Lstiburek, Building Science Corporation
- Roger Barker, Fortifiber
- Steven Suntup, Elastilon
- US Department of Energy, Building Technologies Program, January 2013

Nail-Down Installation Reviewers and Contributors

- Chad Bulen, Bostik
- Curtis Richard, Primattech
- Dave Darche, Bona US
- David Jackson, DriTac
- Dominique Dion, Primattech
- Don Jewell, Loba Wakol
- Don Sgroi, Dependable Floor Inspections
- Mark Lamanno, Titebond/Franklin Adhesives
- Todd Anstett, Powernail
- Tyler Powell, Powernail
- Wolfgang Stauf, Stauf U.S.A.

Glue-Down Installation Reviewers and Contributors

- Beno J Gundlach
- Chad Bulen, Bostik
- Dave Darche, Bona US
- David Jackson, DriTac Flooring Products
- Don Jewell, Loba Wakol
- Mark Lamanno, Titebond/Franklin Adhesives
- Mike Croes, Sika AG
- Steve Lima, Mapei
- Wolfgang Stauf, Stauf U.S.A.

Floating Floor Installation and Sound Control Underlayments Reviewers and Contributors

- Claes Wennerth, Valinge
- Dan Natkin, Mannington
- Dennis Bradway, Mannington
- Gary Bittner, Mohawk
- Jack Boesch, MP Global
- NALFA (North American Laminate Flooring Association) standards publication LF 03-2019
- Roger Barker, Fortifiber
- Steven Suntup, Elastilon
- Uniform Building Code (ICC/UBC) and International Building Code (IBC)

Radiant Heat Taskforce Reviewers and Contributors

- Brett Miller, NWFA Staff Liaison
- Dan Perfitt, Launstein Hardwood Floors
- Dave Diepersloot, Warmboard
- Dino Tremblay, Boa-Franc
- Eric Kochman, Thermosoft International Corporation
- Evan Lauridsen, Shaw Industries
- Francois Roy, Boa-Franc
- Jon Namba, Namba Services
- Julia Billin, Warmly Yours
- Kjell Nymark
- Len Daubler, Shaw Industries
- Les Nelson, Radiant Professionals Alliance (RPA)
- Mark Eatherton, Radiant Professionals Alliance (RPA)
- Monica Irgens, Electro Plastics, Inc.
- Paul Izenstark, Warmboard
- Ron Oliver, Hallmark Floors
- Roy Reichow, National Wood Floor Consultants

- Scott Rosenbaum, Warmly Yours
- Scott Taylor
- Sergey Shlyapintokh, Thermosoft International Corporation
- Steve Marley, Johnson Premium Flooring
- Steve Swanson, Uponor
- Terry Alsberg, Warmboard

Other Reviewers/Contributors

- All Prior Technical Guidelines Committee Members and Contributors
- Artistic Finishes, Inc.
- Ben Suer, Invite You Home Wood Floors
- Crown Heritage Stairs
- Danny Harrington, Galleher LLC
- David Old, Old Wood Floors
- Gary Bittner, Mohawk Industries
- Jeremy Waldorf, Schonox, HPS North America
- Lenny Hall, Endurance Floor Company
- Richard Kass, Master Floor Inspections
- Roy Reichow, National Wood Floor Consultants
- Stairbuilders and Manufacturers Association (SMA)
- Swiffer/Proctor & Gamble
- Tommy Sancic, Olde Wood Floors
- Young Manufacturing Co., Inc.

Publication Editors

- Anita Howard, NWFA
- Brett Miller, NWFA

NWFA Photography, Artwork, Layout and Design

- Brett Miller, NWFA
- Burt Bollinger, NWFA
- Christina Bollinger
- Julie Conway
- Rhonda M. May, NWFA

Photo and Artwork Credits

- Page 2: Top left column photo courtesy of BigStockPhotos © designer491, Image ID 255361372
- Page 3: Bottom right column photo courtesy of BigStockPhotos © New Africa, Image ID 270366829
- Page 4: Left column photo courtesy of BigStockPhotos © AlphaBaby, Image ID: 43609018
- Page 4: Top right column image courtesy of Shutterstock © udaix, Image ID 68571901
- Page 4: Bottom right column photo courtesy of Shutterstock © John Kasawa, Image ID 69868294
- Page 5: Top right column image courtesy of BigStockPhotos © MicroOne, Image ID 134700524
- Page 6: Top right column photo courtesy of BigStockPhotos © graja, Image ID 101196275
- Page 6: Bottom right column photo courtesy of BigStockPhotos © pichunter, Image ID 80743
- Page 8: Top right column photo courtesy of BigStockPhotos © Karimala, Image ID 10683305
- Page 9: Top left column logo courtesy of United States Environmental Protection Agency
- Page 9: Top right column photo courtesy of BigStockPhotos © jarun011, Image ID 128949734
- Page 10: Top right column photo courtesy of BigStockPhotos © kadmy, Image ID 247410625
- Page 13: Top left column photo courtesy of BigStockPhotos © mulderphoto, Image ID 265634614
- Page 13: Top right column photo courtesy of

- BigStockPhotos © pressmaster, Image ID 173879701
- Page 15: Middle left column photo courtesy of BigStockPhotos © grybaz, Image ID 3460815
- Page 15: Top right column photo courtesy of BigStockPhotos © kadmy, Image ID 286199401
- Page 17: Top right column photo courtesy of BigStockPhotos © dragang, Image ID 33477737
- Page 18: Top left column photo courtesy of BigStockPhotos © Nordroden, Image ID 188270467
- Page 18: Top right column photo courtesy of BigStockPhotos © Benedek Alpar, Image ID 300478096
- Page 19: Top left column photo courtesy of BigStockPhotos © photkas, Image ID 14340953
- Page 19: Bottom left column photo courtesy of BigStockPhotos © Dole, Image ID 4002903
- Page 21: Left column images courtesy of Hallmark Floors
- Page 21: Right column middle photo courtesy of BigStockPhotos © Jennifer Bjornson, Image ID 293284057
- Page 21: Right column middle photo courtesy of BigStockPhotos © Jollier, Image ID 268040974
- Page 21: Right column bottom photo courtesy of BigStockPhotos © graphicphoto, Image ID 9539894
- Page 22: Right column all images courtesy of Artistic Finishes, Inc.
- Page 23: All images courtesy of Artistic Finishes, Inc.
- Page 24: Left column images courtesy of SMA, Crown Heritage Stairs, and Young Manufacturing Co., Inc.
- Page 24: Left column bottom image and right column top image courtesy of Artistic Finishes, Inc.
- Page 28: Image courtesy of ©ASHRAE www.ashrae.org
- Page 29-31: All images courtesy of Reuf Design © NWFA 2019
- Page 32: Left column image courtesy of BigStockPhotos © lucadp, Image ID 57962309
- Page 39: All images courtesy of Reuf Design © NWFA 2019
- Page 40: Top left column image courtesy of Reuf Design © NWFA 2019
- Page 43: Top left column image courtesy of Reuf Design © NWFA 2019
- Page 45: Left column and top right column images courtesy of Reuf Design © NWFA 2019
- Page 45: Bottom right column photo courtesy of Tim Moore, Moore & Neville Inc.
- Page 46: Top left column and top right column images courtesy of Reuf Design © NWFA 2019
- Page 47: Bottom right column image courtesy of BigStockPhotos © Sergey Cash, Image ID 191605753
- Page 48: Left column photo courtesy of BigStockPhotos © Sari O'Neal, Image ID 41907850
- Page 48: Top right column photo courtesy of APA
- Page 50: Images provided by APA (The Engineered Wood Association), PFS TECO (PFS Corporation and Timberco Inc.), and TPI (Timber Products Inspection).
- Pages 52-56: All CAD drawings courtesy of Healy Drafting © NWFA 2019
- Page 61: Top photo courtesy of BigStockPhotos © bubutu, Image ID 210768073
- Page 61: Bottom drawing courtesy of Healy Drafting © NWFA 2019
- Page 62: Top photo courtesy of BigStockPhotos © Eugene Sergeev, Image ID 131395346
- Page 62: Bottom drawing courtesy of Healy Drafting © NWFA 2019
- Page 63: Top photo courtesy of BigStockPhotos © unkas_photo, Image ID 90385259
- Page 63: Bottom drawing courtesy of Healy Drafting © NWFA 2019
- Page 64: All drawings courtesy of Healy Drafting © NWFA 2019
- Page 65: Top photo courtesy of BigStockPhotos © schankz, Image ID 312691291
- Page 65: Bottom drawing courtesy of Healy Drafting © NWFA 2019
- Page 68: Photo courtesy of BigStockPhotos © Salamatik, Image ID 287351038
- Page 69: Image courtesy of BigStockPhotos © Mikhail Grachikov, Image ID 305709241
- Page 71: Images courtesy of International Concrete Repair Institute, Inc.
- Page 72: Top right column photo courtesy of BigStockPhotos © kadmy, Image ID 41043349
- Page 72: Bottom right column photo courtesy of BigStockPhotos © kadmy, Image ID 247410625
- Page 73: Top left column photo courtesy of BigStockPhotos © kadmy, Image ID 75275650
- Page 73: Bottom left column photo courtesy of BigStockPhotos © Chinnabanchon, Image ID 308961472
- Page 74: Top left column image courtesy of Reuf Design © NWFA 2019
- Page 74: Bottom left column photo courtesy of BigStockPhotos © DakotaJoan, Image ID 5327708
- Page 75: Top left and top right column images courtesy of Reuf Design © NWFA 2019
- Pages 77-82: All CAD drawings courtesy of Healy Drafting © NWFA 2019
- Pages 78: Photos courtesy of © NWFA 2025
- Pages 83-84, 86: All CAD drawings courtesy of Healy Drafting © NWFA 2019
- Page 82 bottom photo courtesy of Rick Jones
- Page 87: Top photo courtesy of Shutterstock © Dario Sabljak, Image ID 370224791
- Pages 87-97: All CAD drawings courtesy of Healy Drafting © NWFA 2019
- Page 98: Chart courtesy of ©ASHRAE www.ashrae.org
- Pages 102-104: All CAD drawings courtesy of Healy Drafting © NWFA 2019
- Pages 108-109: All CAD drawings courtesy of Healy Drafting © NWFA 2019
- Page 111: Top right column photo courtesy of BigStockPhotos © Wichien Tep, Image ID 200002588
- Pages 113-115: All CAD drawings courtesy of Healy Drafting © NWFA 2019
- Page 122: CAD drawings courtesy of Healy Drafting © NWFA 2019
- Pages 124-127: All CAD drawings courtesy of Healy Drafting © NWFA 2019
- Page 133: CAD drawings courtesy of Healy Drafting © NWFA 2019
- Page 136: Drawings courtesy of Healy Drafting © NWFA 2019
- Page 139: Photo courtesy of Don Jewell, Loba Wakol
- Page 144: CAD drawings courtesy of Healy Drafting © NWFA 2019
- Page 161: Top right column photo courtesy of BigStockPhotos © devon, Image ID 4889164



RIBADAO
WOOD BOUTIQUE

connect with us!



leave us a review!

15701 NW 15th Avenue Miami, FL 33169 - U.S.A

Phone: +1 888.505.2827

Email: purchasing@ribadao.com

For more information
visit our website

www.ribadaoamericas.com